

**TECHNICAL MANUAL**

**APPLICATION AND REMOVAL OF  
ORGANIC COATINGS,  
AEROSPACE AND NON-AEROSPACE  
EQUIPMENT**

F09603-87-D-2264  
FA8501-04-F-0029

This revision supersedes TO 1-1-8 dated 23 April 2001 through Change 6 dated 14 May 2004 and incorporates TO 1-1-8S-2, dated 4 May 2004.

**DISTRIBUTION STATEMENT A** - Approved for public release; distribution is unlimited. WR-ALC PA Certificate No. PA05-0758. Other request for this document shall be referred to 584 CBSS/GBMUDE, Robins AFB, GA 31098. Questions concerning technical content shall be referred to AFRL/MLS-OLR.

Published Under Authority of the Secretary of the Air Force

---

**15 FEBRUARY 2006**

**LIST OF EFFECTIVE PAGES**

INSERT LATEST CHANGED PAGES. DESTROY SUPERSEDED PAGES.

NOTE The portion of the text affected by the changes is indicated by a vertical line in the outer margin of the page. Changes to illustrations are indicated by shaded or screened areas, or by miniature pointing hands.

Dates of issue for original and changed pages are:

Original . . . . .0. . . . .15 February 2006

TOTAL NUMBER OF PAGES IN THIS PUBLICATION IS 166 CONSISTING OF THE FOLLOWING:

Page No.	*Change No.	Page No.	*Change No.	Page No.	*Change No.
Title . . . . .	0				
A . . . . .	0				
i - xi . . . . .	0				
xii Blank . . . . .	0				
1-1 - 1-2. . . . .	0				
2-1 - 2-28. . . . .	0				
3-1 - 3-17. . . . .	0				
3-18 Blank. . . . .	0				
4-1 - 4-23. . . . .	0				
4-24 Blank. . . . .	0				
5-1 - 5-17. . . . .	0				
5-18 Blank. . . . .	0				
6-1 - 6-26. . . . .	0				
7-1 - 7-5. . . . .	0				
7-6 Blank. . . . .	0				
8-1 - 8-8. . . . .	0				
A-1 - A-3. . . . .	0				
A-4 Blank. . . . .	0				
B-1 - B-12. . . . .	0				
Glossary 1 - Glossary 5. . . . .	0				
Glossary 6 Blank. . . . .	0				

\* Zero in this column indicates an original page.

## TABLE OF CONTENTS

Chapter	Page	Chapter	Page	
LIST OF ILLUSTRATIONS . . . . .	vi	2.9	MECHANICAL REMOVAL OF ORGANIC FINISH SYSTEMS . . . . .	2-12
LIST OF TABLES . . . . .	vi	2.10	MECHANICAL REMOVAL METHODS OTHER THAN PLASTIC MEDIA OR MEDIUM PRESSURE WATER BLASTING FOR METAL SUBSTRATES . . . . .	2-13
FOREWORD . . . . .	vii	2.10.1	Abrasive Blasting . . . . .	2-13
SAFETY SUMMARY . . . . .	xi	2.10.2	Hand or Motor-Driven Abrasive Removal . . . . .	2-13
1 INTRODUCTION AND GENERAL DISCUSSION OF COATING MATERIALS AND TERMS . . . . .	1-1	2.10.3	Hand Held Abrasive Removal . . . . .	2-14
1.1 INTRODUCTION . . . . .	1-1	2.10.4	Motor Driven Abrasive Removal . . . . .	2-14
1.2 GENERAL DISCUSSION OF ORGANIC COATINGS . . . . .	1-1	2.10.5	Stainless Steel (CRES) and Nickel Based Alloys . . . . .	2-14
1.2.1 Coatings Systems For Metal Surfaces . . . . .	1-1	2.10.6	Dust Removal . . . . .	2-14
1.2.2 Aircraft Protective Finish Systems . . . . .	1-1	2.11	PMB REMOVAL METHOD . . . . .	2-19
1.3 ORGANIC COATING . . . . .	1-1	2.11.1	Media Type . . . . .	2-19
2 ORGANIC FINISH SYSTEM REMOVAL . . . . .	2-1	2.11.2	Media Authorized for Air Force Use . . . . .	2-19
2.1 INTRODUCTION . . . . .	2-1	2.11.3	Operational Parameters for Metallic Surfaces . . . . .	2-21
2.2 GENERAL . . . . .	2-1	2.11.4	Usage Restrictions . . . . .	2-21
2.3 PREPARATION FOR PAINT REMOVAL . . . . .	2-2	2.11.5	Operational Parameters for Non-Metallic (Composite) Surfaces . . . . .	2-21
2.3.1 Application . . . . .	2-3	2.11.6	Operation Safety Requirements . . . . .	2-22
2.3.2 Procedures . . . . .	2-3	2.11.7	Personnel Qualifications . . . . .	2-22
2.4 ORGANIC FINISH SYSTEM REMOVAL . . . . .	2-4	2.11.8	Pre-blast Preparation . . . . .	2-22
2.5 CHEMICAL REMOVAL OF ORGANIC FINISH SYSTEMS FROM METAL SUBSTRATES . . . . .	2-4	2.11.9	Postblast Cleaning . . . . .	2-23
2.6 CHEMICAL REMOVERS . . . . .	2-4	2.11.10	Specific Technical Data and Work Directives . . . . .	2-23
2.6.1 Remover For Alkyd Base Primer and Lacquer or Alkyd Enamel Topcoats Over Alkyd Base Primer . . . . .	2-5	2.11.11	Disposal of Plastic Media Used in Paint Removal Operations . . . . .	2-23
2.6.2 Remover For Epoxy and Polyurethane Primers and Epoxy and Polyurethane Top-Coats Over Epoxy or Polyurethane Primers . . . . .	2-5	2.11.12	Contamination Testing of Plastic Media . . . . .	2-23
2.6.3 Remover For Polysulfide Primer With A Polyurethane Topcoat . . . . .	2-6	2.12	MPW REMOVAL METHOD . . . . .	2-25
2.6.4 Removers For Environmental Compliance . . . . .	2-6	2.12.1	Preparation . . . . .	2-25
2.6.5 Chemical Remover Selection For Depot Removal Operations . . . . .	2-7	2.12.2	Paint Removal Operations . . . . .	2-26
2.7 GENERAL OVERALL CHEMICAL REMOVAL PROCEDURES . . . . .	2-8	2.12.3	Post-Paint Removal Cleaning . . . . .	2-26
2.8 CHEMICAL REMOVAL PROCEDURES FOR CONFINED LOCATIONS . . . . .	2-11	2.12.4	Operational Safety Requirements . . . . .	2-26
		2.12.5	Personnel Qualification . . . . .	2-27
		2.13	REMOVAL OF THERMOPLASTIC POWDER COATING . . . . .	2-27
		2.13.1	Removal Procedures . . . . .	2-27
		2.14	PAINT REMOVAL ON NON-METALLICS . . . . .	2-27
		2.14.1	Removal Requirements . . . . .	2-27
		2.14.2	Mechanical Paint Removal on Fiber Glass, Arranged Fiber (Kevlar)/Epoxy, and Graphite or Boron Fiber/Epoxy Composite Surfaces . . . . .	2-28

**TABLE OF CONTENTS - CONTINUED**

Chapter	Page	Chapter	Page
3 SURFACE PREPARATION AND CHEMICAL PREPAINT SURFACE TREATMENT .....	3-1	3.1.24 Surface Treatment Process For Magnesium .....	3-15
3.1 SURFACE PREPARATION FOR PAINTING AND CHEMICAL PREPAINT SURFACE TREATMENT .....	3-1	3.1.25 Surface Preparation For Steel .....	3-16
3.1.1 Surface Preparation For Painting ..	3-1	3.1.26 Masking .....	3-16
3.1.2 Surface Preparation For Repair or Over Coating of Damaged Organic Coating .....	3-1	3.1.27 Tack Ragging .....	3-17
3.1.3 Scuff Sanding For Overspraying Existing Coating Systems On Aircraft .....	3-2	4 PAINTING APPLICATION METHODS ...	4-1
3.1.4 Solvent Wiping For Surface Preparation .....	3-3	4.1 GENERAL .....	4-1
3.1.5 Surface Preparation For MIL-C-27725/SAE AMS-C-27725 Integral Fuel Cell Coating .....	3-5	4.2 SPRAY METHODS .....	4-1
3.1.6 Reactivation of Newly Applied Primer or Tiecoat .....	3-7	4.2.1 HVLP Spray .....	4-1
3.1.7 Surface Preparation, Unpainted Surfaces .....	3-7	4.2.2 Hot Spray .....	4-1
3.1.8 Corrosion Removal, Chemical and Mechanical .....	3-7	4.2.3 Airless Spray .....	4-2
3.1.9 Preparation for Prepaint Treatment, Unpainted Surfaces .....	3-7	4.2.4 Air-Assisted Airless Spray .....	4-2
3.1.10 Water Break Inspection .....	3-7	4.2.5 Electrostatic Spray .....	4-2
3.1.11 Evidence of Inadequate Cleaning ..	3-8	4.3 SPRAY PAINTING EQUIPMENT, GENERAL .....	4-2
3.1.12 Corrosion Removal Prepaint Compound, Aluminum .....	3-8	4.3.1 HVLP Spraying Systems .....	4-2
3.1.13 Prepaint Chemical Corrosion Removal Materials .....	3-8	4.3.2 Spray Gun, General .....	4-2
3.1.14 Application of MIL-C-38334/SAE AMS-1640 Solution/Not LOX Compatible .....	3-8	4.3.3 Classes of Spray Guns .....	4-2
3.1.15 Surface Treatment Materials For Aluminum .....	3-8	4.3.4 Material Containers .....	4-3
3.1.16 Touch-Up of Damaged Aluminum Surface Treatment MIL-C-5541/SAE AMS-C-5541 .....	3-9	4.3.5 Air Compressors .....	4-5
3.1.17 No-Rinse Process For Surface Treatment of Aluminum .....	3-9	4.3.6 Air Regulators or Transformers ...	4-5
3.1.18 Mixing MIL-C-81706/MIL-DTL-81706 Solution .....	3-11	4.3.7 Air Condensers .....	4-5
3.1.19 Application of MIL-C-81706/MIL-DTL-81706 Solutions .....	3-11	4.3.8 Air Supply .....	4-5
3.1.20 Alternate Surface Preparations For Aluminum Surfaces (PreKote SP) .....	3-13	4.3.9 Hose .....	4-5
3.1.21 Application of PreKote SP .....	3-13	4.4 SPRAY PAINTING .....	4-5
3.1.22 Use of PreKote SP on Exterior Surfaces Where Paint and Primer Have Been Removed During Scuff Sand, Touch-up or Repair ..	3-14	4.4.1 Gun Techniques .....	4-5
3.1.23 Corrosion Removal Solution For Magnesium .....	3-15	4.4.2 Gun Adjustments .....	4-11
		4.4.3 Painting Difficulties and Remedies ..	4-12
		4.5 CLEANING AND MAINTENANCE .....	4-22
		4.6 MECHANICAL PAINT GUN WASHER .....	4-23
		5 PAINTING OPERATIONS FOR AIRCRAFT AND EQUIPMENT .....	5-1
		5.1 GENERAL .....	5-1
		5.2 SAFETY AND HEALTH ASPECTS OF PAINTING .....	5-1
		5.2.1 Respiratory Protection .....	5-3
		5.3 SPRAY BOOTHS AND PAINTING AREAS, GENERAL .....	5-3
		5.4 PAINT BOOTH TYPES .....	5-3
		5.4.1 Dry-Type Booth .....	5-3
		5.4.2 Air-Water Wash Type Booth .....	5-3
		5.4.3 Cleaning and Maintenance .....	5-4
		5.4.4 Part and Equipment Painting Operations .....	5-4
		5.5 AIRCRAFT PAINTING OPERATIONS .....	5-4
		5.5.1 Depot Level Aircraft Painting Operations .....	5-4
		5.5.2 Field Level Aircraft Painting Operations .....	5-5

## TABLE OF CONTENTS - CONTINUED

Chapter		Page	Chapter		Page
5.5.3	Electrostatic Aircraft Painting . . . . .	5-5	6.7.3	Viscosity . . . . .	6-4
5.5.4	Atmospheric Conditions For Painting . . . . .	5-6	6.8	BLUSHING . . . . .	6-5
5.5.5	Test Panels . . . . .	5-6	6.9	RESINS . . . . .	6-5
5.5.6	Material Requirements, General . . . . .	5-7	6.9.1	Alkyds . . . . .	6-5
5.6	THE AIRCRAFT PAINTING PROCESS SEQUENCE OF EVENTS . . . . .	5-7	6.9.2	Acrylics . . . . .	6-5
5.6.1	Aircraft Paint Application Sequence . . . . .	5-8	6.9.3	Vinyls . . . . .	6-5
5.6.2	Overspraying Existing Coating Systems On Aircraft and Aerospace Equipment . . . . .	5-9	6.9.4	Phenolics . . . . .	6-5
5.6.3	Curing of Finishes . . . . .	5-10	6.9.5	Silicones . . . . .	6-5
5.6.4	Coating Thickness Measurements . . . . .	5-10	6.9.6	Epoxies . . . . .	6-5
5.6.5	Allowable Coating Thickness . . . . .	5-10	6.9.7	Polyurethane . . . . .	6-6
5.6.6	Inspection Control . . . . .	5-11	6.10	ADHESION . . . . .	6-6
5.6.7	Soil Barrier Coating . . . . .	5-13	6.11	PRIMERS . . . . .	6-6
5.7	INTERIOR FINISHING PROCEDURES AND OPERATIONS . . . . .	5-13	6.12	COATINGS AND COATING SYSTEMS . . . . .	6-6
5.7.1	Preparation For Coating . . . . .	5-13	6.12.1	USAF Standard Polyurethane Aircraft Coating System . . . . .	6-6
5.7.2	Coating Application . . . . .	5-13	6.12.2	Primer Coating, Epoxy, For Aircraft Application, Specification MIL-PRF-23377 . . . . .	6-6
5.7.3	Refinishing of Fiber Glass Components . . . . .	5-13	6.12.3	Primer Coating, Epoxy, VOC Complaint, Chemical and Solvent Resistant, MIL-PRF-85582 . . . . .	6-8
5.8	MAINTENANCE PAINTING . . . . .	5-13	6.12.4	Primer Coating, Polyurethane, TT-P-2760 . . . . .	6-8
5.8.1	Epoxy or Polyurethane Primer/Polyurethane Topcoat . . . . .	5-13	6.12.5	Primer Coating, Elastomeric, Polysulfide Corrosion Inhibiting, PR-1432GV . . . . .	6-9
5.8.2	Primer and Polyurethane Touch Up . . . . .	5-13	6.12.6	Tiecoat, Non-Chromated . . . . .	6-10
5.8.3	Aerosol Touchup . . . . .	5-14	6.12.7	Polyurethane Topcoat, High Solids (MIL-PRF-85285, Type I) . . . . .	6-11
5.8.4	Brush/Roller Touchup . . . . .	5-15	6.12.8	Curing of Complete Polyurethane System . . . . .	6-13
5.8.5	Brush Application . . . . .	5-15	6.12.9	Coating Compound (Wash Primer), Metal Pretreatment, Resin-Acid, Specification MIL-C-8514 . . . . .	6-13
5.8.6	Roller Application . . . . .	5-16	6.12.10	Primer, Coating, Inorganic, Zinc Dust Pigmented, Self-Curing, For Steel Surfaces, Specification MIL-P-38336/SAE AMS-P-38336 . . . . .	6-16
5.8.7	Temporary Protection . . . . .	5-16	6.12.11	Primer Coating For Steel Surfaces, Specification MIL-PRF-26915 . . . . .	6-17
5.8.8	Powder Coating . . . . .	5-16	6.12.12	Paint, Aluminum, Heat Resisting (1200° F) TT-P-28 . . . . .	6-18
6	USAF STANDARD COATING SYSTEMS FOR AIRCRAFT AND EQUIPMENT . . . . .	6-1	6.12.13	Enamel, Alkyd, Gloss, Low VOC Content, TT-E-489 . . . . .	6-18
6.1	CLASSIFICATION OF ORGANIC COATINGS . . . . .	6-1	6.12.14	Enamel, Heat Resistant (204° C or 400° F), A-A-3054 . . . . .	6-18
6.2	CONSTITUENTS OF ORGANIC COATINGS . . . . .	6-1	6.12.15	Coating, Sprayable, Strippable, Protective, MIL-PRF-6799 . . . . .	6-18
6.3	PIGMENTS . . . . .	6-1	6.12.16	Resin Coating, Unpigmented, For Engine Components and Metal Parts, MIL-PRF-3043 . . . . .	6-19
6.4	VEHICLE . . . . .	6-1	6.12.17	Coating Kit, Epoxy, For Interior of Steel Fuel Tanks, MIL-PRF-4556 . . . . .	6-19
6.5	PREPARATION OF COATING MATERIALS FOR USE, GENERAL . . . . .	6-1			
6.6	MIXING AND THINNING OF COATING MATERIALS, GENERAL . . . . .	6-2			
6.6.1	Method of Mixing . . . . .	6-2			
6.6.2	Mixing Test . . . . .	6-2			
6.7	SOLVENTS, DILUENTS AND THINNERS . . . . .	6-3			
6.7.1	Volatility . . . . .	6-3			
6.7.2	Thinners . . . . .	6-4			

## TABLE OF CONTENTS - CONTINUED

Chapter	Page	Chapter	Page
6.12.18	6-20	8.1.2	8-1
Coating, Corrosion Preventive, For Aircraft Integral Tanks, MIL-C-27725/SAE AMS-C-27725 . . . . .		8.1.3	8-1
6.12.19	6-22	8.1.4	8-1
Coating Compound, Nonslip (For Walkways), A-A-59166 . . . . .		8.1.5	8-1
6.12.20	6-23	8.1.6	8-1
Coatings, Polyurethane, Rain Erosion Resistant For Exterior Aircraft and Missile Parts, MIL-C-83231/SAE AMS-C-83231 . . . . .		Paint Scheme and Marking Approval Process . . . . .	8-1
6.12.21	6-23	8.1.7	8-1
Coating System, Polyurethane, Non-Yellowing White, Rain Erosion Resistant, Thermally Reflective, MIL-C-83445/SAE AMS-C-83445 . . . . .		89th AW, 201AS, and the 1st Helicopter Squadron . . . . .	8-1
6.12.22	6-23	8.1.8	8-1
Leading Edge Polyurethane Rain Erosion Resistant Tape . . . . .		U.S. Air Force Aerial Demonstration Squadron The Thunderbirds . . . . .	8-1
<b>7 APPLICATION AND REMOVAL OF DECALS AND SILK SCREENING . . . . .</b>	<b>7-1</b>	8.1.9	8-1
7.1	7-1	8.1.10	8-1
DECALS - GENERAL . . . . .		Low Observable Aircraft . . . . .	8-1
7.1.1	7-1	8.1.11	8-1
Surface Preparation . . . . .		Aircraft Received From Other Services . . . . .	8-1
7.1.2	7-1	8.1.12	8-2
Application Procedures For Decals and Colored Marking Stripes . . . . .		Service Tests . . . . .	8-2
7.2	7-1	8.1.13	8-2
SMALL DECALS AND MARKING STRIPES . . . . .		Decals . . . . .	8-2
7.2.1	7-1	8.1.14	8-2
Decals Up To 12 inches x 2 inches . . . . .		Applicable References . . . . .	8-2
7.2.2	7-1	8.2	8-2
Film For Striping . . . . .		STANDARD EXTERIOR FINISHES MARKINGS AND INSIGNIA FOR USAF AIRCRAFT . . . . .	8-2
7.3	7-2	8.2.1	8-2
LARGE EMBLEMS AND LETTERS USING HINGE APPLICATION METHOD . . . . .		Metal Exterior Finishes . . . . .	8-2
7.4	7-3	8.2.2	8-2
DECALS APPLIED USING APPLICATION TAPE . . . . .		Titanium and Corrosion Resistant Steel . . . . .	8-2
7.5	7-3	8.2.3	8-2
EDGE SEALING . . . . .		Treatment of Metal Exteriors . . . . .	8-2
7.6	7-4	8.2.4	8-2
APPLICATION OF PREMASKED DECALS . . . . .		Policy Guidance . . . . .	8-2
7.7	7-4	8.2.5	8-3
DECAL REMOVAL . . . . .		Camouflage . . . . .	8-3
7.8	7-4	8.2.6	8-3
APPLICATION OF MARKINGS WITH SILKSCREEN . . . . .		Special Purpose Exterior Solar Resistant Finishes . . . . .	8-3
7.8.1	7-4	8.2.7	8-3
Materials and Equipment for Silk-screening . . . . .		Paint Facility/Finish Identification Block . . . . .	8-3
7.9	7-4	8.3	8-3
SURFACE PREPARATION . . . . .		Markings and Insignia for USAF Aircraft . . . . .	8-3
7.9.1	7-4	8.3.1	8-3
Application . . . . .		General . . . . .	8-3
7.9.2	7-4	8.3.2	8-3
Topcoat Application . . . . .		USAF Marking . . . . .	8-3
7.10	7-5	8.3.3	8-3
APPLICATION OF MARKINGS USING STENCILS . . . . .		American Flag Marking . . . . .	8-3
7.10.1	7-5	8.3.4	8-4
Surface Preparation . . . . .		United States of America Marking . . . . .	8-4
7.10.2	7-5	8.3.5	8-4
Mounting Stencil . . . . .		Aircraft Radio Call Numbers . . . . .	8-4
7.10.3	7-5	8.3.6	8-4
Painting of Stencils . . . . .		AMC Standard Radio Call Numbers . . . . .	8-4
<b>8 EXTERIOR FINISHES, INSIGNIA AND MARKINGS, APPLICABLE TO USAF AIRCRAFT . . . . .</b>	<b>8-1</b>	8.3.7	8-5
8.1	8-1	ACC Standard Radio Call Numbers . . . . .	8-5
GENERAL . . . . .		8.4	8-5
8.1.1	8-1	Organization Insignia or Emblems . . . . .	8-5
Purpose . . . . .		Outstanding Unit Award Marking . . . . .	8-5
		8.4.1	8-5
		Crew Names . . . . .	8-5
		8.4.2	8-5
		Aircraft Names . . . . .	8-5
		8.4.3	8-5
		Local Station Numbers and Markings . . . . .	8-5
		8.4.4	8-5
		Propeller Markings . . . . .	8-5
		8.4.5	8-6
		Helicopter Main Rotor Blade Markings . . . . .	8-6
		8.4.6	8-6
		Helicopter Tail Rotor Blade Markings . . . . .	8-6
		8.4.7	8-6
		Identification Markings of Jettisonable Aircraft Components . . . . .	8-6
		8.4.8	8-6

## TABLE OF CONTENTS - CONTINUED

Chapter		Page	Chapter		Page
8.4.9	Markings for Servicing, Ground Handling and Hazard Warning . .	8-6	8.4.19	Conspicuity Markings . . . . .	8-7
8.4.10	Markings for Engine Compartment Fire Access Panel . . . . .	8-6	8.4.20	Arctic Markings . . . . .	8-7
8.4.11	Ejection Seats . . . . .	8-6	8.5	Establishing Requirements for Mission Activity, Crew Accomplishment, and Esprit de Corps Insignia and Markings . . . . .	8-8
8.4.12	Identification of Ballistic Hose Assemblies . . . . .	8-6			
8.4.13	Markings for Tank Filler Areas . . . .	8-7	APPENDIX A	SHELF-LIFE EXTENSION PROCEDURES . . . . .	A-1
8.4.14	Marking of Emergency Lighting (Flashlight) for Cargo &Transport Aircraft . . . . .	8-7	APPENDIX B	STANDARD AIR FORCE AIRCRAFT MARKINGS . . . . .	B-1
8.4.15	Markings for Walkways and Steps .	8-7	GLOSSARY . . . . .	Glossary-1	
8.4.16	Markings for Composite/Honeycomb Panels . . . . .	8-7			
8.4.17	Removable Escape Panels . . . . .	8-7			
8.4.18	Markings for Unmanned aerial Vehicles . . . . .	8-7			



## LIST OF ILLUSTRATIONS

Figure	Title	Page	Figure	Title	Page	
4-1	Nozzle Pressure Gauge .....	4-1	7-2	Applying Marking Stripe .....	7-2	
4-2	Simple Spray System Setup .....	4-4	7-3	Applying Large Emblems (Step 1) .....	7-2	
4-3	Airless Spray System .....	4-5	7-4	Applying Large Emblems (Step 2) .....	7-2	
4-4	Complete Spray System .....	4-6	7-5	Applying Large Emblems (Step 3) .....	7-2	
4-5	Sectional View of Spray Gun .....	4-7	7-6	Applying Large Emblems (Step 4) .....	7-2	
4-6	Proper Installation of Air Compressor, Piping .....	4-8	7-7	Use of Application Tape (Step 1) .....	7-3	
4-7	Right and Wrong Methods of Spraying .....	4-9	7-8	Use of Application Tape (Step 2) .....	7-3	
4-8	Fifty Percent Overlap .....	4-10	7-9	Use of Application Tape (Step 3) .....	7-3	
4-9	Cross Coating .....	4-10	7-10	Use of Application Tape (Step 4) .....	7-3	
4-10	Spray Gun Adjustments .....	4-11	7-11	Edge Sealing .....	7-4	
4-11	Excessive Spray Fog .....	4-12	B-1	Edge Sealing .....	B-2	
4-12	Paint Leaks From Spray Gun .....	4-12	B-2	National Star Insignia on Swept Wings .....	B-3	
4-13	Gun Sputters Constantly .....	4-13	B-3	Form of Letters and Numerals .....	B-4	
4-14	Orange Peel .....	4-19	B-4	Typical Marking For Paint Facility/Finish Identification Block .....	B-5	
4-15	Sandpaper Finish .....	4-19	B-5	“UNITED STATES OF AMERICA” AND AMC Standard Marking Sample .....	B-6	
4-16	Wrinkling .....	4-20	B-6	Distinctive Unit, Serial Number and ACC Standard Sample .....	B-7	
4-17	Crazing .....	4-20	4-21	B-7	Aircraft Markings, Servicing and Precautioning .....	B-8
4-18	Cracking .....	4-20	4-21	B-8	Ground Here, International Symbol .....	B-10
4-19	Blistering .....	4-21	4-21	B-9	Markings For Fire Access Panel .....	B-10
4-20	Fish Eyes .....	4-21	4-21	B-10	Helicopter Tail Boom Markings .....	B-11
4-21	Lifting .....	4-21	4-21	B-11	Typical Emergency Instruction Markings .....	B-11
4-22	Pitting or Cupping .....	4-21	4-21	B-12	Typical Emergency Entry Markings .....	B-12
5-1	Sempen .....	5-14				
5-2	Sempen Mixing .....	5-14				
5-3	Sempen Application .....	5-14				
5-4	Spray Tool .....	5-15				
6-1	Zahn Cup .....	6-4				
7-1	Applying Small Decal. ....	7-1				

## LIST OF TABLES

Table	Title	Page	Table	Title	Page
2-1	Hand Held Abrasives .....	2-15	5-2	Allowable Coating Thickness for Production Level Finishing (Depot, Original Manufacture, Field) .....	5-11
2-2	Motor Driven Abrasives .....	2-16			
2-3	Abrasive Materials .....	2-17	5-3	Gloss Requirements .....	5-12
2-4	Minimum Recommended Controls and PPE for Abrasive Blasting Operations <sup>a</sup> .....	2-18	6-1	Thinning Ratio (Volume) for Wash Primer MIL-C-8514 .....	6-15
3-1	Minimum Recommended Controls and PPE for Surface Preparation Operations <sup>a</sup> .....	3-4	6-2	Leading Edge Tape Materials/Tools .....	6-24
3-2	Wipe Solvents .....	3-5	8-1	Standard Markings .....	8-4
4-1	Spray Coating Troubles, Possible Causes, and Remedies .....	4-13	8-2	Aircraft Authorized American Flag Markings .....	8-4
5-1	Minimum Recommended Controls and PPE for Priming and Painting Operations <sup>a</sup> .....	5-2	8-3	Aircraft Authorized United States of America Markings .....	8-4
			8-4	Aircraft Authorized Multi-Colored Blade Tip Markings .....	8-6
			A-1	Viscosity and Pot Life .....	A-3



## FOREWORD

### 1 PURPOSE.

The purpose of this technical order is to prescribe standard procedures for the removal, application, and maintenance of coating systems on Air Force systems and equipment. Its applicability is generally imposed by reference in system or item technical data. It also should be used where there is an absence of paint process requirements in system or item technical data. System and item (SM/IM) management activities have an obligation to require the use of this technical order to the maximum practical extent. It reflects the use of standard materials and procedures that meet Defense Standardization Program, AF Corrosion Prevention and Control Program, and Air Force policy (AFI 21-105) requirements. SM/IM offices should modify standard requirements or specify alternate requirements only as needed to support the specific requirements of their systems and equipment as stated in TO 00-5-1. Where there is a conflict between this general TO and the weapon system specific TO, the weapon system specific TO will take precedence. Such departures from standard should also be coordinated with all applicable OCRs (e.g., Corrosion Control, Ground Safety, Bioenvironmental Engineering, Environmental Management).

### 2 SCOPE.

This technical manual specifies procedures, materials, and equipment for preparing surfaces and correctly applying effective finishes to interiors and exteriors of Air Force aircraft, missiles, and associated equipment. Painting techniques are suggested and common difficulties discussed. Procedures for applying complete coating systems are given. Some basic discussion of paint technology is included and a glossary of painting terms appended.

### 3 ABBREVIATIONS AND ACRONYMS.

The following nonstandard abbreviations are used in this manual. For definition of standard abbreviations and acronyms, refer to ASME 14.38.

ACGIH	American Conference of Government Industrial Hygienists	EPA	Environmental Protection Agency
ALC	Air Logistic Center	FSC	Federal Stock Classes
BCE	Base Civil Engineer	GL	Gallon
BES	Base Environmental Services	gm	Grams
CFM	Cubic Feet per Minute	HAZMAT	Hazardous Materials
CRES	Corrosion Resistant Steel	HDI	Hexamethylene Diisocyanate
DR	Drum	HVLP	High Volume Low Pressure
EAID	Equipment Authorization Inventory Data	ID	Inside Diameter
		IPB	Illustrated Parts Breakdown
		IPI	In-Process Inspection
		LEL	Lower Explosive Limit
		LOX	Liquid Oxygen
		MEK	Methyl-Ethyl-Ketone
		ml	milliliter
		moh	Measure of Hardness
		MPW	Medium Pressure Water
		MSDS	Material Safety Data Sheets
		NATO	North Atlantic Treaty Organization
		NDI	Non-Destructive Inspection
		No.	Number
		NSN	National Stock Number
		OSHA	Occupational Safety and Health Act
		PAPR	Powered Air-Purifying Respirator
		PCBTF	Parachlorobenzotrifluoride
		PD	Purchase Description
		PMB	Plastic Media Blasting
		PN	Part Number
		PPE	Personal Protective Equipment
		PPM	Parts per Million
		PSI	Pound-force per square inch
		PSIG	Pounds Per Square Inch Gauge
		PVC	Polyvinyl Chloride
		QPL	Qualified Products List
		SG	Specific Gravity
		SLED	Shelf-Life Extension Data
		SM/IM	System Manager/Item Manager
		SPD	Systems Program Director
		SPO	System Program Office
		TNP	Touch-N-Prep
		UAV	Unmanned aerial Vehicle
		UV	Ultra Violet

VOC Volatile Organic Compound

**List of Related Publications - Continued****4 LIST OF RELATED PUBLICATIONS.**

The following publications are to be used for reference. Maintain only those publications required to perform assigned mission. This list is not all inclusive. This list also includes general information TOs pertaining to inspection, maintenance, storage, and use of personal flying and survival equipment.

**List of Related Publications**

Number	Title	Number	Title
ASTM D 1153	Methyl-Isobutyl-Ketone (Repl. TT-M-268)	CID A-A-3054	Paint, Heat Resisting (204° C) (Repl. TT-E-496)
ASTM D 13	Spirits of Turpentine (Repl. TT-T-801)	CID A-A-3118	Brush, Plater's, Hand (Curved Handle Type) (Repl. H-B-178)
ASTM D 304	n-Butyl Alcohol (Butanol) (Repl. TT-B-846)	CID A-A-3164	Synthetic Lacquer, Camouflage, Exterior, VOC Compliant (Repl. TT-L-20)
ASTM D 329	Acetone, Technical (Repl. O-A-51)	CID A-A-3165	Lacquer, Gloss, for Aircraft Use (Repl. TT-L-32)
ASTM D 330	Ethylene Glycol Monobutyl Ether (2-Butoxyethanol) (Repl. TT-E-776)	CID A-A-341	Pigment, Aluminum, Powder and Paste (Repl. TT-P-320)
ASTM D 5136	Xylene (Repl. TT-X-916)	CID A-A-55827	Chromium Trioxide, Technical (Repl. O-C-303)
ASTM D 740	Methyl-Ethyl-Ketone (Repl. TT-M-261)	CID A-A-58054	Abrasive Mats, Non-Woven, Non-Metallic (Repl. MIL-A-9962)
CCC-C-440	Cloth, Cheese, Cotton, Bleached and Unbleached	CID A-A-58060	Fluorocarbons and Other Refrigerants
CID A-A- 857	Thinner, Dope and Lacquer (Cellulose Nitrate) (Repl. MIL-T-19544)	CID A-A-59105	Nitric Acid, Technical
CID A-A-1043	Wool, Steel (Repl. FF-W-1825 steel type)	CID A-A-59106	Ethylene Glycol Monoethyl Ether, Technical (Repl. TT-E-781)
CID A-A-1044	Wool, Metallic (Copper and Aluminum) (Repl. FF-W-1825 aluminum type)	CID A-A-59107	Toluene, Technical (Repl. TT-T-548)
CID A-A-1047	Paper, Abrasive, Silicon Carbide, Waterproof (Repl. by ANSI B74.18)	CID A-A-59124	Deck Covering, Lightweight, Non-Slip (Repl. MIL-W-5044)
CID A-A-1800	Varnish, Oil, Spar (Repl. TT-V-119)	CID A-A-59133	Cleaning Compound, High Pressure (Steam) Cleaning (Repl. MIL-C-5543)
CID A-A-2522	Rags, Wiping (Cotton and Cotton Synthetic)	CID A-A-59146	Cleaning Compound, Alkali, Boiling Vat (Soak) or Hydrosteam (Repl. P-C-436)
CID A-A-3003	Lacquer, Spraying, Clear and Pigmented, for Interior Use (Repl. TT-L-58)	CID A-A-59166	Coating Compound, Non-Slip, for Walkways (Repl. MIL-W-5044)
CID A-A-3007	Thinner for Phenol-Formaldehyde and Medium Oil and Styrenated Alkyd Paints and Varnishes (Repl. TT-T-306)	CID A-A-59281	Cleaning Compound, Solvent Mixtures (Repl. MIL-C-38736)
		CID A-A-59282	Alcohol, Ethyl (Repl. O-E-760)
		CID A-A-59485	Plastic Material, Pressure Sensitive, for Aerospace Identification and Marking (Repl. MIL-P-38477)

## List of Related Publications - Continued

Number	Title
DOD-P-15328	Primer (Wash), Pretreatment, (Formula No. 117 for Metals)
GGG-C-520	Cloth and Disks, Abrasive, Open-Mesh, Waterproof (Repl. by ANSI B74.18)
MIL-A-8625	Anodic Coatings for Aluminum and Aluminum Alloys
MIL-B-23958	Brush, Cleaning, Aircraft, Metal Brightening
MIL-C-16555	Coating Compound, Stripable, Sprayable
MIL-C-5541/SAE AMS-C-5541	Chemical Conversion Coatings for Aluminum and Aluminum Alloys
MIL-C-81706/MIL-DTL-81706	Chemical Conversion Materials, for Coating Aluminum and Aluminum Alloys
MIL-C-85054	Corrosion Preventive Compound, Water Displacing, Clear (AMLGUARD)
MIL-C-8514	Coating Compound, Metal Pretreatment, Resin-Acid
MIL-C-8779	Color, Interior, Aircraft, Requirements for
MIL-DTL-24441	Paint, Epoxy-Polyamide, General Specification for
MIL-PRF-24635	Enamel, Silicone Alkyd Copolymer (Repl. MIL-P-15936)
MIL-P-15930	Primer Coating, Shipboard, Vinyl-Zinc Chromate
MIL-PRF-23377	Primer Coatings, Epoxy, High Solids
MIL-P-38336/SAE AMS-P-38336	Primer Coating, Inorganic Zinc Dust Pigmented, Self Curing, for Steel Surfaces
MIL-P-85891	Plastic Media for Removal of Organic Coatings
MIL-PRF-121	Barrier Material, Grease Proof, Water Proof, Flexible
MIL-PRF-131	Barrier Material, Water Vapor Proof, Grease Proof, Flexible

## List of Related Publications - Continued

Number	Title
MIL-PRF-22750	Coating, Epoxy, High Solids
MIL-PRF-25134	Remover, Paint and Lacquer, Solvent Type
MIL-PRF-26915	Primer Coating for Steel Surfaces
MIL-PRF-3043	Resin Coating, Permanent, for Engine Components and Metal Parts
MIL-PRF-4556	Coating Kit, Epoxy, for Interior of Steel Fuel Tanks
MIL-PRF-6799	Coating, Sprayable, Stripable, Protective, Water Emulsion
MIL-PRF-680	Degreasing Solvent (Repl. P-D-680)
MIL-PRF-83936	Remover, Paint, Tank type; for Aircraft Wheels, Landing Gear Components, and Other Aircraft and Support Equipment
MIL-PRF-85285	Coating, Polyurethane, High-Solids
MIL-PRF-85570	Cleaning Compound, Aircraft Exterior
MIL-PRF-85582	Primer Coatings, Epoxy, Waterborne
MIL-PRF-87937	Cleaning Compound, Aerospace Equipment
MIL-PRF-87978	Remover, Paint, Epoxy and Polyurethane Systems, Tank Type, Ambient temperature, for Aircraft Wheels and Landing Gear Components
MIL-STD-7179	Finishes, Coatings, and Sealants for Protection of Aerospace Weapon Systems (Repl. MIL-F-7179)
MIL-T-81772 SAE AMS-1640	Thinner, Aircraft Coating Corrosion Removing Compound, for Aircraft Surfaces (Repl. MIL-C-38334)
SAE AMS-3002	Alcohol, Ethyl, Specially Denatured (Repl. MIL-A-6091)

## List of Related Publications - Continued

Number	Title
SAE AMS-3819	Cloths, Cleaning
SAE AMS-C-27725	Coating, Corrosion Preventive, Polyurethane, for Aircraft Integral Fuel Tanks (to 250° F) (Repl. MIL-C-27725)
SAE AMS-C-83231	Coating, Polyurethane, Rain Erosion Resistant, for Exterior Aircraft and Missile Plastic Parts (Repl. MIL-C-83231)
SAE AMS-C-83445	Coating System, Polyurethane, Non-Yellowing White, Rain Erosion Resistant, Thermally Reflective (Repl. MIL-C-83445)
SAE AMS-M-3171	Magnesium Alloy, Processes for Corrosion Protection (Repl. MIL-M-3171)
SAE AMS-T-21595	Tapes, Pressure-Sensitive Adhesive, Masking, Non-Staining-for Aircraft Painting Applications (Repl. MIL-T-21595)
SAE AMS-T-23397	Tapes, Pressure Sensitive Adhesive, for Masking During Paint Removal Operations (Repl. MIL-T-23397)
SAE AS-22805	Spray Kit, Self Pressurized (Repl. MIL-S-22805)
TT-E-751	Ethyl Acetate, Technical
TT-I-735	Isopropyl Alcohol
TT-N-95	Naphtha, Aliphatic
TT-P-1757	Primer Coating, Alkyd Base, One Component
TT-P-2760	Primer Coating, Polyurethane, Elastomeric, High Solids
TT-P-28	Paint, Aluminum, Heat Resisting (1200° F)
VV-P-236	Petrolatum, Technical
TO 00-25-172	Ground Servicing of Aircraft and Static Grounding/Bonding

## List of Related Publications - Continued

Number	Title
TO 00-25-4	Depot Maintenance of Aerospace Vehicles and Training Equipment
TO 00-5-1	Air Force Technical Systems
TO 1-1-24	Maintenance, Repair, and Electrical Requirements for Fiberglass Airborne Radomes
TO 1-1-24-1	Supplementary Manual -- Maintenance, Repair, and Electrical Requirements for Fiberglass Airborne Radomes
TO 1-1-689 Volumes I, III, and V	Cleaning and Corrosion Control, Avionics and Electronics
TO 1-1-690	General Advanced Composite Repair Manual
TO 1-1-691	Aircraft Weapon Systems Cleaning and Corrosion Control
TO 31-1-221	Field Instructions for Painting and Preserving Electronics Command Equipment
TO 35-1-3	Corrosion Prevention, Painting, and Marking of USAF Support Equipment (SE)
TO 42B1-1-15	Cross Reference - NATO/ASCC Interchangeability of Aviation Fuels, Lubricants and Allied Products
TO 42C2-1-7	Process Instructions-Metal Treatments, Electro deposition of Metals, and Metal Surface Treatments Meet Air Force Maintenance Requirements

## SAFETY SUMMARY

### 1 GENERAL SAFETY INSTRUCTIONS.

This manual describes physical and chemical processes, which may cause injury or death to personnel, or damage to equipment if not properly followed. This safety summary includes general safety precautions and instructions that must be understood and applied during operation and maintenance to ensure personnel safety and protection of equipment. Prior to performing any task, the WARNINGS, CAUTIONS, and NOTES included in the task shall be reviewed and understood.

### 2 WARNINGS, CAUTIONS, AND NOTES.

WARNING, CAUTION, and NOTE statements have been strategically placed throughout this text prior to operating or maintenance procedures, practices or conditions considered essential to the protection of personnel (WARNING) or equipment and property (CAUTION), or when essential to highlight a practice (NOTE). A WARNING, CAUTION or NOTE will apply each time the step to which it refers is repeated. Prior to starting any task, the WARNINGS, CAUTIONS, and NOTES for that task will be reviewed and understood. Refer to the materials list table at the beginning of the appropriate work package for material used during maintenance of this equipment. The detailed warnings for hazardous materials are listed separately in the safety summary in the Hazardous Materials paragraph. Other warnings, cautions, and notes which appear in this manual are not listed separately in this safety summary, and are defined as follows:

**WARNING**

Highlights an essential operating or maintenance procedure, practice, condition, statement, etc., which, if not strictly observed, could result in injury to, or death of, personnel or long term health hazards.



Highlights an essential operating or maintenance procedure, practice, condition, statement, etc. which if not strictly observed, could result in damage to, or destruction of, equipment or loss of mission effectiveness.

#### NOTE

Highlights an essential operating or maintenance procedure, condition, or statement.

### 3 HAZARDOUS MATERIALS WARNINGS.

Hazardous Material Warnings are provided through use of Hazard Symbols listed below. Consult the HAZARDOUS MATERIALS DESCRIPTION below or MSDS OSHA Form 20 or equivalent for specific information on hazards, effects and protective equipment requirements. If you do not have an MSDS for the material involved, contact your supervisor, or base Safety or Bioenvironmental Engineering Offices.



# CHAPTER 1

## INTRODUCTION AND GENERAL DISCUSSION OF COATING MATERIALS AND TERMS

### 1.1 INTRODUCTION.

#### NOTE

See Chapter 8 for Air Force policy on determining when individual aircraft are to be repainted or touched up.

The surfaces of aircraft, missiles, and associated equipment are subjected to hostile environments both natural and man-made. Inadequate control or prevention of metal corrosion or other forms of surface deterioration is costly and can shorten weapon or equipment life, hinder mission accomplishment, or endanger personnel or equipment. To add to their ability to resist detrimental environments, surfaces are coated in various ways with a variety of materials. Coatings are divided into two main groups: inorganic and organic. The principal and most versatile means of protection is organic coating, or "paint". In general, a suitable organic coating system, properly applied, offers greater protection against corrosion on metals than an inorganic finish (such as a metallic plating) alone and is more easily maintained. This technical manual also covers some inorganic materials, insofar as they are applied in surface preparation for painting by personnel involved with paint removal and painting operations.

### 1.2 GENERAL DISCUSSION OF ORGANIC COATINGS.

#### NOTE

Precautionary measures shall be taken to prevent paint and paint removal waste from contaminating air, water, or soil. Some of the chemicals utilized for painting and paint removal require treatment or other special control prior to disposal. Disposal of materials shall be accomplished under the direction of the Base Safety Office, Base Civil Engineer, Bioenvironmental Engineer, and Environmental Management in accordance with applicable directives and in a manner that will not result in violation of local, state, or federal pollution criteria. Detailed information for disposal is cited in AFI 32-1067, AFI 32-7041, AFI 32-7042, AFPAM 32-7043, AFI 32-7045, AFI 32-7080, AFI 32-7086, and AFOSH STD 91-501.

To provide optimum protection from deterioration and corrosion, the proper coating systems (combination of pretreatment, primer, and topcoat) must be selected for a specific application. The selection of the proper coating system

depends on the material to be coated, the environment to which the item will be subjected, and the service life requirement of the coating. No single coating or coating system can perform adequately on all types of surfaces under all conditions to which Air Force equipment is subjected. For example, a coating paint conforming to Specification MIL-C-27725/SAE AMS-C-27725 is good for fuel immersion service, but is inadequate for exposure to an industrial atmosphere or high humidity conditions. Many primers and topcoats can be used in various combinations; however, some primers are specifically formulated for a particular type topcoat. One Component, Alkyd Base Primers are for use under enamels. Use of this primer under epoxy or polyurethane coatings will result in premature failure of the coating system.

**1.2.1 Coatings Systems For Metal Surfaces.** Unless protected, metals surfaces (with the exception of stainless steel, titanium and some of the more exotic metals) react with oxygen and various contaminants in the atmosphere, particularly in the presence of moisture, to form rust or other corrosion products. The most common method of preserving metals is by applying organic coatings.

**1.2.1.1** Polishing, buffing, and waxing of aircraft and parts is prohibited unless authorized and directed by the MAJCOM Senior Logistics Official.

**1.2.2 Aircraft Protective Finish Systems.** Military Standard MIL-STD-7179 covers the general requirements for protective finishes and coatings on aerospace weapon system structures and parts. (It does not necessarily govern coatings on aeronautical equipment such as propellers or power plants, nor those on accessories such as motors, generators, instruments, etc.) The level of coating protection is specified depending on the environment to which the weapon system is to be subjected.

### 1.3 ORGANIC COATING.

An organic coating or paint may be defined as a carbon based liquid or semi-liquid material which is applied to a surface by some mechanical means and which, when dried or cured, will provide an adherent film of certain desired characteristics. Organic coatings are variously classed as paints, enamels, varnishes and lacquers. As these classifications are not always practical, due to modern formulations, and because the coating materials dealt with in this technical manual are almost exclusively organic in chemical structure, the preferred term "organic coating" is used to designate finishing materials in general. For the purposes of this technical manual the term is extended to include some heavy elasto-



## TO 1-1-8

meric materials which are not truly “paints,” and also certain chemical surface-treating materials which are not truly organic. These materials may or may not be applied by painters,

but are closely associated with painting operations. Also, the term “to paint” will continue to be used to signify the application of organic coatings by painters.

## CHAPTER 2

### ORGANIC FINISH SYSTEM REMOVAL

#### 2.1 INTRODUCTION.

The most important factor in removal of organic finish systems (coatings/paints) is complete removal without damaging surfaces on which they are applied. A variety of materials and either chemical or mechanical methods can remove finish systems. In choosing a material and a method, a compromise between maximum removal power and maximum protection for the equipment being stripped must be made. Accessibility of areas to be stripped can dictate the types of materials and methods to be used. For these reasons, only those materials and methods described in this chapter, subject to noted restrictions, are authorized for general use in organic finish system removal from Air Force equipment. Adherence to removal procedures and their sequence of performance in this chapter is mandatory. Other removal materials and methods can be authorized for limited and specific applications, but only when specifically approved and defined in system peculiar aircraft and/or equipment technical orders. The term "Depot Level" in this chapter refers to organizations and facilities which are involved in complete aircraft stripping operations on a routine, if not daily basis. This includes the Air Logistic Centers (ALCs) and contract stripping operations. It does not include field-level maintenance facilities.

#### NOTE

National Stock Numbers (NSNs), if assigned, for chemical removers, abrasives, and other materials and equipment authorized in this chapter are in Federal Stock Classes (FSC) 5345/50, 6850, and 8135 and FSC 7500, 7900, and 8000. Consult the current FED LOG and GSA Catalog and/or the D043 System to convert specification and part numbers to NSNs and for ordering and pricing information and shelf life codes.

#### 2.2 GENERAL.

#### NOTE

Each time an aircraft is completely depainted, the following information shall be documented in the aircraft historical record, AFTO Form 95: 1. Type of paint removal process used, 2. Where accomplished, and 3. Date accomplished.

Organic finish systems shall be removed from Air Force aircraft and equipment only when the condition of deterioration of the system indicates the need for removal or when required in a system peculiar technical order to perform a specified inspection of the underlying structure. This applies to stripping of components and small areas of aircraft and

equipment as well as to the entire surface of aircraft or equipment. Removal of the entire exterior organic finish system from aircraft shall be accomplished in accordance with the criteria specified in Chapter 8 of this manual and the Aircraft System Program Manager's Service Life Paint Plan. Prior to any organic finish system removal, the following steps shall be taken in all cases:

- a. Ensure that the facility to be used for finish system removal operations meets all the safety, fire precaution, health promotion, and environmental requirements in applicable AFOSH and NFPA standards. Precautionary measures shall be taken to prevent paint and paint removal waste from contaminating air, water, or soil. Prior to performance of finish system removal operations, all personnel must be trained on Personal Protective Equipment (PPE) as required in AFOSH STD 48-137 and 91-501. Personnel who are not wearing appropriate PPE shall not perform finish system removal operations.
- b. Ensure that the facility to be used for finish system removal operations provides the proper precautionary measures for disposal of finish system removal waste products as required by AFI 32-7041, AFI 32-7080, and AFI 32-7086 to prevent contamination of lakes, rivers, and streams. Many chemicals used in finish system removal operations and finish system residues require special treatment and control prior to disposal. Disposal shall be accomplished under the direction of the Base Safety Office, the Base Civil and Bioenvironmental Engineers, and the Environmental Management Office in a manner which will not violate local, state, and federal pollution regulations. Consult AFI 32-1067, AFI 32-7041, AFI 32-7042, AF PAM 32-7043, AFI 32-7045, AFI 32-7080, AFI 32-7086, and AFOSH STD 91-501 for detailed information on disposal of finish system removal waste.
- c. Determine the type of organic finish system to be removed so that the proper material and method for removal can be chosen from those listed in this chapter. Consult aircraft and/or equipment system peculiar technical orders and drawings, component drawings, aircraft historical records (AFTO Form 95), and/or the aircraft exterior finish identification marking on the aircraft (reference Chapter 8) to help in this determination. If the finish system cannot be determined from these documents or they are not available, determine the finish system as follows:
  - (1) Rub a small area on the surface from which the finish system is to be removed vigorously with a cotton rag wet with ASTM D 329 acetone. If the finish system

is removed, it is a lacquer or alkyd enamel coating. If it is not removed, or very little is removed, it is a polyurethane or an epoxy coating.

- (2) For polyurethane and epoxy coatings, scrape off the topcoat from a small area down to the primer coating with a knife blade or razor blade. If the primer is rubbery and a tan-gray color, it is a polysulfide primer. If the primer is hard and either a yellow, light brown, or dark green (olive drab) color, it is either an epoxy or a polyurethane primer.
- d. As a last step, study the removal operation to be performed and determine the most logical and efficient process for the job. If confined areas are involved, they shall be protected during a general overall removal operation, and shall be stripped using the special procedures in this chapter for these areas. If fiberglass, kevlar, or other composites are involved, they shall be stripped using the special procedures outlined later in this technical order. For extensive removal operations, such as removal of the entire exterior finish system on aircraft and large pieces of equipment, a detailed sequential step-by-step process specification confirming to all of the requirements in this chapter shall be prepared and followed. All personnel involved with finish system removal shall be trained in and thoroughly familiar with all requirements of this chapter.

### 2.3 PREPARATION FOR PAINT REMOVAL.

All aircraft will be de-energized per AFOSH STD 91-17, support equipment or components must be properly prepared for paint removal operations. Additionally, it is essential that all facilities and equipment for paint removal operations meet the safety and environmental requirements for the processes to be employed. Once the process for paint removal has been selected, use the following preparation requirements to prepare the aircraft, support equipment or component.

- a. Inspect all surfaces to be stripped for grease, oil, and dirt. These materials act as a barrier between the finish system and the chemical or abrasive removers and will contaminate recoverable air-driven abrasives. This can cause excessive man-hour expenditures, longer flow times, and additional waste generation during removal operations. Small amounts of these contaminants do not cause a problem; but if surfaces are exceptionally dirty, oily, or greasy, they shall be washed in accordance with TO 1-1-691 prior to removal operations. After washing, surfaces shall be either wiped dry, or sufficient time shall be allowed for them to air dry prior to removal operations. Small areas or components may be cleaned using a solvent wipe per Chapter 3 of this manual.

- b. Position the aircraft, equipment, or component from which the finish system is to be removed in a covered facility. If chemical removal methods are to be used, this facility shall be capable of maintaining the ambient air temperature within the range of 50° F to 100° F. In addition, the item from which the finish system is to be chemically removed shall be placed in the facility for a length of time sufficient to allow its surface temperature to reach 50° F to 90° F prior to application of the remover. While chemical removal can be accomplished within the ambient air temperature range of 50° F to 100° F, severe difficulties will be encountered outside a temperature range of 70° F to 90° F. Below 70° F, chemical removal is very inefficient because the action of chemical removers is extremely slow; so the flow time, man-hours, and amount of remover required for chemical removal operations will be increased significantly. Above 90° F, the solvents in chemical removers evaporate so rapidly that removal efficiency is severely reduced and its drying on the surface makes it severely difficult to clean the finish system and remover residue from surfaces. This too will cause a significant increase in flow time, man-hours, and amount of remover required for chemical removal operations.
- c. Protect all special areas, equipment, and materials by masking or other specified protective devices. For chemical removal operations, masking shall be accomplished with MIL-PRF-131, Class 1, barrier material and MIL-T-23397/SAE AMS-T-23397, Type II, (72-hour protection) aluminum backed, pressure sensitive tape. For extensive stripping operations such as depot level complete exterior finish system removal from aircraft and large pieces of equipment, use only 3M Co. Part Number (PN) 425 tape (3M Co. Address: Minnesota Mining and Manufacturing, Industrial Tape Div., 3M Center, St. Paul MN 55101). This is the only tape which will provide adequate protection for the extended time period involved with this type of operation. The engineering support activity for this technical order evaluates and approves tapes for this source control listing using the latest issue of MIL-T-23397/SAE AMS-T-23397. Chemical stripper CeeBee R-256 is used as the testing agent for stripper resistance. Make sure that the plastic coated side of the MIL-PRF-131, Class 1, barrier material is toward the surface being protected or the plastic will be deteriorated by chemical removers.

#### NOTE

Specific 3M Co. PN 425 Tape NSNs can be found using the following part number "425 + \*/\* + in" in Fed Log Supply System.

- d. For air and water-driven abrasive removal operations unless otherwise noted, the same materials listed for chemical removal operations shall be used for masking of areas which will not be exposed to direct impingement of the abrasive media to prevent abrasive media intrusion. Impact stripping tape shall be applied with hot glue to mask areas which will be exposed to direct impingement of the bicarbonate of soda and water and plastic blast media as an alternate for masking for Plastic Media Blasting (PMB) subject to the restrictions following.

Materials:

Hot Glue Gun - Polygun PC Applicator 3M Co.

PN 99302 or

PN AIS 7000K, 4940-01-512-7768

Hot Glue - 3M Co.

PN 3748 TC, 8040-01-390-9728 or

PN AIS 5050, 6850-01-512-7763

Cotton Rope

Caulking Cord - More - Tite Putty

Impact Stripping Tape

80 mils thick, 20 oz/in peel strength, 250% to 300% elongation, Shore A hardness 70-80

Anchor Continental BT-100 or

3M Co. PN 500 Series (ex. 500, 506, 528, etc.)

Impact Stripping Tapes 500 are available in 30 feet long rolls under NSNs:

9390-01-359-7367 (1 in wide/9 rolls per box)

9390-01-359-7368 (2 in wide/6 rolls per box)

9390-01-359-7369 (3 in wide/3 rolls per box)

These are rubberized tapes capable of withstanding a direct nozzle blast from PMB or bicarbonate of soda and water blast equipment for a maximum of two seconds.

**2.3.1 Application.** Hot glue is used to seal seams, covers and access panel gaps less than 3/16 inch and to seal seams and edges of impact tape for added protection. Fluid wicks fabricated from cotton rope are sealed in place using this material, and are installed at saturated seams prior to sealing with hot glue. Caulking cord is used to fill seams and gaps in excess of 3/16 inch. Impact tape is used to protect areas not to be blasted.

**2.3.2 Procedures.**



Media intrusion into engines, gun assemblies, avionics, or actuators can severely damage these components. Extreme care must be exercised to mask every possible intrusion site.

Cover all antennas with impact tape. When masking off large areas, such as vents, use hard cardboard, sheet metal or equivalent, reinforced with impact tape over the side that will be exposed to PMB or bicarbonate of soda and water blast media. When placing cover in position, use impact tape to hold in place, and apply hot glue to seal edges. Seal all edges of all impact tape with hot glue to eliminate possibility of tape peeling. In seams or protrusions where slow hydraulic leaks compromise masking integrity, install a fluid wick (cotton rope) with a minimum four inch length and seal in place with hot glue. Aircraft mold line drain holes shall be plugged with rubber stoppers or equivalent and sealed with hot glue.

**2.3.2.1** A detailed step-by-step checklist specifying the masking procedure shall be prepared for all finish system removal operations. This checklist shall be used to ensure that all required masking is accomplished prior to removal operations and that all masking is removed afterwards. The following areas shall be masked and/or otherwise protected for chemical and air or water driven abrasive finish system removal operations:

- a. Close all windows, doors, and hatches on aircraft or equipment; and mask gaps between the structure and these components. For air or water driven abrasive removal operations, these gaps may be stuffed full with sheets of MIL-PRF-131, Class 1, barrier material or heavy duty (0.004 inch thick) polyethylene or vinyl plastic film sheet to prevent abrasive media intrusion.
- b. Mask all transparent plastic and glass surfaces such as windows, canopies, and blisters; because they will be crazed, frosted, or lose transparency if exposed to chemical removers or if air or water-driven abrasive media strikes them. For air or water-driven abrasive removal operations, optional form-fitting metal or wood shields may be fabricated for canopies and blisters in conjunction with 3M Co. PN 510, 3M Co. 500, 510, or Bron Tape, PN 818 material cut to the exact size for windows. These tapes are available in 30-foot long rolls under NSNs 7510-01-300-2124 (1 in), 7510-01-300-2125 (2 in), 7510-01-300-2126 (3 in), 7510-01-300-2127 (4 in), up to 30 in (special order).

Care must be taken to prevent hot glue from dripping on skin or into eyes. Wear safety goggles.

**CAUTION**

Care should be taken when cutting and trimming of the barrier/tape to prevent damage to the transparent plastic and glass surfaces.

- c. Mask all radomes, antennas, fiber glass and/or composite structure, and rubber boots and/or all other rubber or elastomer surfaces to prevent chemical removers and air or water driven abrasive media from damaging these materials and/or components. (See Paragraph 2.14 for composite paint stripping procedure).
- d. Mask all engine intake and exhaust openings and all openings or ports leading to interior cavities of structure to prevent entrapment of chemical removers and abrasive media. When masking aircraft pitot static ports and probes, the probe and port openings shall be covered with a disk of barrier material or paper prior to application of pressure sensitive tape to prevent tape adhesive from contaminating the interior and the openings of these probes and ports. The tape shall cover the barrier material or paper completely and overlap onto the aircraft surface approximately one-half inch past the outside diameter of the pitot static port circular hole pattern.
- e. Mask all seams of removable inspection and equipment access panels and personnel doors for chemical removal operations to prevent seepage of the remover into joints.
- f. Mask all edges, repairs, and loose fasteners on honeycomb and metal-to-metal adhesively bonded panels and doors for chemical removal operations to prevent chemical removers from damaging adhesives and disbonding adhesively bonded structure.
- g. Fabric covered control surfaces (rudders, elevators, ailerons, etc.), shall be either completely masked or removed from the aircraft prior to any paint removal operations in the area of these components. Fabric can be damaged by chemical removers and air or water driven abrasive media.
- h. Sometimes, replacements for very detailed or highly specialized decals are very difficult to obtain. Mask these types of decals using barrier material over the decal if directed to save them.
- i. Mask all other areas specified in and as directed by system peculiar aircraft or equipment technical orders, such as aircraft -23 corrosion technical orders.

**NOTE**

For extensive chemical removal operations such as entire aircraft exterior finish system, some residual stripping will be required. For this limited stripping, it may be more efficient and practical to strip those areas of the finish system which will be covered by masking tape by the hand residual finish system removal procedures in this chapter prior to masking for the over all media removal operation. This is authorized as long as extreme care is taken to prevent damage to areas which require protection by masking, all remover and open finish system residue is thoroughly removed from the stripped areas and areas around them, and surfaces on which masking tape will be applied are solvent wiped with a cotton rag wetted with TT-I-735 isopropyl alcohol followed by wiping dry with a clean cotton rag before the alcohol evaporates.

**2.4 ORGANIC FINISH SYSTEM REMOVAL.**

There are two methods for removal of organic finishing systems; chemical and mechanical. Each method has its own set of procedures, precautions, restrictions, and limitations; and therefore, each will be explained separately. If confined areas or non-metallic structural materials are involved in the removal operation, specific procedures for these areas are presented in this chapter and shall be used.

**2.5 CHEMICAL REMOVAL OF ORGANIC FINISH SYSTEMS FROM METAL SUBSTRATES.**

Chemical removal procedures and their sequence of performance are essentially the same for all types of organic finish systems, all types of chemical removers, and either limited or extensive removal operations. However, the type of chemical remover used depends on the type of organic finish system to be removed.

**2.6 CHEMICAL REMOVERS.**

The type of chemical remover used to remove an organic finish system varies according to the type of system to be removed: alkyd base primer, lacquer or alkyd enamel topcoats over alkyd base primer, epoxy and polyurethane primers, epoxy and polyurethane topcoats over epoxy or polyurethane primers, or polyurethane topcoat over polysulfide primer. The approved types of chemical removers which shall be used to remove each of these organic finish systems are identified below along with precautions to be used for each type:



**NOTE**

All chemical removers have a shelf life of six months from the date of manufacture unless otherwise specified, if they are stored and maintained under the proper conditions. They should be ordered in quantities and by intervals which allow all chemical removers on-hand to be used prior to the shelf life expiration date. Chemical removers shall be stored in a protected area (out of direct sunlight) capable of maintaining a temperature of 40° F to 100° F to prevent them from freezing or being exposed to excessively high temperatures. Chemical removers rapidly deteriorate at temperatures exceeding 100° F, and many of them become corrosive. Exposure to freezing temperatures causes them to separate in such a way that the components cannot be remixed to a homogeneous solution. In either case, they become totally ineffective. While not necessarily unsatisfactory after six months of age, chemical removers do deteriorate and lose removal efficiency on aging beyond six months; and some start to become corrosive. A definite age control program shall be established for chemical removers by the using activity, and any material which is questionable due to improper storage and/or exceeding its shelf life shall be laboratory tested and updated in accordance with AFM 23-110 prior to use. Particular attention shall be given to the corrosivity of chemical removers during testing.

### 2.6.1 Remover For Alkyd Base Primer and Lacquer or Alkyd Enamel Topcoats Over Alkyd Base Primer.

Remover, Paint and Lacquer, Solvent Type MIL-PRF-25134 is the approved chemical remover for alkyd base primer, TT-P-1757 and alkyd enamel topcoats, TT-E-489, etc.; on USAF aircraft, missile, or equipment metal surfaces. This remover is a heavy bodied or very viscous liquid, usually yellow in color, consisting primarily of methylene chloride (dichloromethane), a small amount of ammonia, and small amounts of thickening and wetting agents designed to remove multiple coats of alkyd enamels by solvent action. This remover shall be applied full strength, with no dilution, to the surface from which the finish system is to be removed in a smooth, even coat by either a brush or a non-atomizing type sprayer. This remover normally causes enamels to wrinkle within 5 to 15 minutes after application, but a longer dwell time is often required if numerous coats are present on the surface and environmental conditions are not ideal. Products conforming to MIL-PRF-25134 have been tested and proven not to cause hydrogen embrittlement of high-strength steels or corrosion beyond established limits of the various metals used on USAF aircraft, missiles, and equipment. These products are identified in a Qualified Products List (QPL) for MIL-PRF-25134, and only those products listed on the most current revision of this QPL shall be purchased for and used on USAF aircraft, missiles, or equipment. Questions regarding products qualified to MIL-PRF-25134 shall be referred to WR-ALC/LGEC. Products listed in this chapter for removal

of epoxy and polyurethane primers and epoxy and polyurethane topcoats over epoxy or polyurethane primers can and may be used to remove alkyd base primer and alkyd enamel topcoats over alkyd base primer in lieu of MIL-PRF-25134 remover as long as precautions for these materials given in this chapter are followed. It should be noted, however, that these removers are more expensive than MIL-PRF-25134 removers and require much more stringent measures for waste disposal and pollution control.

**2.6.2 Remover For Epoxy and Polyurethane Primers and Epoxy and Polyurethane Top-Coats Over Epoxy or Polyurethane Primers.** There are no USAF approved specification removers for these finish systems, but proprietary removers of two different types, phenolic and non-phenolic/non-cresylic, have been tested and approved by the Air Force Corrosion Prevention and Control Office for use on USAF aircraft, missile or equipment metal surfaces. Each remover is chemically unique and not necessarily interchangeable with others for a particular task. Production variables affecting the choice of removers include the brand and age of the finish system, type of surface to which it is applied (metal type, large/small area, horizontal/vertical surface), local climate, capabilities of local industrial waste treatment facilities, Environmental Protection Agency (EPA) and local environmental restrictions on remover and paint residue disposal, and local medical and bioenvironmental authority concerns for worker contact with the more reactive type products. Phenolic type removers are much more efficient than the non-phenolic/non-cresylic type removers for removal of these finish systems, but they present waste disposal problems and require treatment facilities capable of handling them. Each activity is authorized and encouraged to service test the listed removers to evaluate effectiveness for their own particular situation and to select a preferred remover and one or two alternates, if possible, to promote competition. These removers are heavy bodied or very viscous liquids, usually yellow or brown in color, designed to remove these finish systems by solvent action. These removers shall be applied full strength with no dilution in a smooth even coat by either a brush or a non-atomizing type sprayer. Removers authorized to remove epoxy and polyurethane finish systems from USAF aircraft, missiles, and equipment metal surfaces are identified by PN and source of supply.

#### 2.6.2.1 Phenolic Type Removers, NSN 8010-01-023-0343 (55 GL DR), 6850-01-512-6620 (8 oz).

Part Number	Source of Supply
B&B 1567 & 9500	B&B Tritech, Inc. Cage Code: 21361 875 W 20 <sup>th</sup> St Miami FL 33266-0776
CeeBee R-256	CeeBee Div., McGean-Roch, Inc. Cage Code: 8U841 9520 E. CeeBee Dr Downey, CA 90241
PR-3500	Eldorado Chemical Co., Inc.

**TO 1-1-8**

Part Number	Source of Supply
	Cage Code: 55208 P.O. Box 34837 San Antonio, TX 78265-4837
5292 & 5351	Turco Products Inc. Henkel Surface Tech Cage Code: 1N6B3 3300 Industrial Way Tucker, GA 30084-5390
3812	Omega Chemical Products Group Cage Code: 0B5U9 620 North Ave New Rochelle, NY 10801
Stripper #18	Crest Industrial Chemicals, Inc. Cage Code: 77513 6341 Beverly Hill Houston, TX 77057-6501

much more efficient to remove polyurethane topcoats with one of the removers listed for epoxy and polyurethane finish systems first and then to remove the polysulfide primer with one of the removers listed in this paragraph. This method is highly recommended to avoid excessive use of materials, man-hours, and flow time in removal of this finish system. These removers are heavy bodied or very viscous liquids designed to remove polysulfide primer with a polyurethane topcoat by solvent action; preferably after the polyurethane topcoat has been removed with one of the removers listed for epoxy and polyurethane finish systems. These removers shall be applied full strength, with no dilution, in a smooth even coat by either a brush or a non-atomizing type sprayer. The removers authorized to remove polysulfide primer with a polyurethane top-coat from USAF aircraft, missiles, and equipment metal surfaces are identified below by PN and source of supply, 8010-01-270-3637 (55 GL DR).

**2.6.2.2 Non-Phenolic/Non-Cresylic Type Removers, 8010-01-261-6874 (55 GL DR), 8010-00-348-7716 (5 GL), 8010-01-167-9692 (1 GL).**



The maximum shelf life of PN B&B 5151A Remover is three months. This remover shall not be used if it is older than three months from the date of manufacture.

Part Number	Source of Supply
B&B 4411	B&B Tritech, Inc. Cage Code: 21316 875 W 20 <sup>th</sup> St Miami, FL 33266-0776
PR-3400	Eldorado Chemical Co., Inc. Cage Code: 55208 P.O. Box 34837 San Antonio, TX 78265-4837
Inland AP-599	Inland Chemical Corp. Cage Code: None 1810 Magnavox Way Fort Wayne, IN 46804
Intex 857	Intex Products, Inc. Cage Code: 78304 P.O. Box 6648 Greenville, SC 29606
CeeBee A-292	CeeBee Div.; McGean-Roch, Inc. Cage Code 8U841 9520 E. CeeBee Dr. Downey, CA 90241

Part Number	Source of Supply
B&B 5151A & 9500	B&B Tritech, Inc. Cage Code: 21316 875 W 20 <sup>th</sup> St Miami, FL 33266-0776
CeeBee R-458	CeeBee Div., McGean-Roch, Inc. Cage Code: 8U841 9520 E. CeeBee Dr Downey, CA 90241

**2.6.3 Remover For Polysulfide Primer With A Polyurethane Topcoat.** There are no USAF approved specification removers for this finish system, but proprietary removers of two different types, phenolic and non-phenolic/non-cresylic, have been tested and approved by the Air Force Corrosion Prevention and Control Office for use on USAF aircraft, missile, and equipment metal surfaces. While they will remove military specification polyurethane topcoats, it is

**2.6.4 Removers For Environmental Compliance.** In addition to removers listed in preceding paragraphs, removers based on benzyl alcohol and alternate alkaline materials have been tested and approved for use on USAF aircraft, missile, or equipment metal surfaces by the Air Force Corrosion Prevention and Control Office. These products offer the advantage of reduced hazardous waste generation and contain ingredients not currently listed as hazardous materials for occupational health or environmental contamination. However, skin and eye protection is still required. Consult the local bioenvironmental engineer for minimum personal protection requirements and the local environmental coordinator to establish proper handling and disposal procedures for the removers and the process waste. These products have flash points ranging from 150° F to over 200° F so they are not classified as flammable materials, but as combustible materials. Their use should be coordinated with the local fire department. These products do not afford the same production rates as the traditional methylene chloride and phenolic type removers, and removal efficiency on each type of coating



varies for each product. They are chemically unique and not necessarily interchangeable for a particular task. The products are generally effective for topcoat removal but have differing degrees of effectiveness with primers. The following removers are authorized to remove organic finishes from USAF aircraft, missiles and equipment metal surfaces:

2.6.4.1 Removers for epoxy/polyurethane primer and polyurethane topcoats 6850-01-495-0236 (55 GL DR), 6850-01-495-0135 (5 GL), 6850-01-495-0148 (1 GL), 6850-01-523-0007 (8 oz).

Part Number	Source of Supply
CeeBee E-1092A, E-2000, E-2002A & E-2012	CeeBee Div, McGean-Rohco Inc. Cage Code: 8U841 9520 E. CeeBee Dr Downey CA 90241

PR-3131/PR-3133	Eldorado Solutions, Inc. Cage Code: 55208 14350 Lookout Road San Antonio, TX 78233 DBA of Eldorado Chemical CO Inc.
541	EZE Products Inc. Cage Code: 78304 PO Box 5744 Greenville, SC 29606
6813, 6813E, & 6840S	Turco Products Inc. Henkel Surface Tech Cage Code: 1N6B3 3300 Industrial Way Tucker, GA 30084-5390
B&B 9400 & 9575	B&B Tritech, Inc. Cage Code: 21361 875 W 20 <sup>th</sup> St Miami, FL 33266-0776

2.6.4.2 Removers for polysulfide primers 6850-01-495-0150 (55 GL DR), 6850-01-495-0149 (5 GL), 6850-01-495-0235 (1 GL).

Part Number	Source of Supply
CeeBee E-1058 & E-1058A	CeeBee Div, McGean-Rohco Inc. Cage Code: 8U841 9520 E. CeeBee Dr Downey, CA 90241
SR-125A, SR-145, & PR-3133	Eldorado Solutions, Inc. Cage Code: 55208 14350 Lookout Road

Part Number	Source of Supply
5151B	San Antonio, TX 78233 DBA of Eldorado Chemical CO Inc. B&B Tritech, Inc. Cage Code: 21361 875 W 20 <sup>th</sup> St Miami, FL 33266-0776
542	EZE Products Inc. Cage Code: 78304 PO Box 5744 Greenville, SC 29606
D-Zolve GL-15-33	Solvent Kleene, Inc Cage Code: 0L8C9 119 Foster St, Bldg 6 Peabody, MA 01960

2.6.5 Chemical Remover Selection For Depot Removal Operations. Each Air Logistics Center (ALC), either alone or in concert with other ALC's shall prepare a purchase description (PD) with a qualified products list (QPL). This QPL will establish testing and qualification procedures for removers authorized for use in their facilities from among those listed in Paragraph 2.6.2.1, Paragraph 2.6.2.2, Paragraph 2.6.4.1, Paragraph 2.6.3, and Paragraph 2.6.4.2. Testing for removers in Paragraph 2.6.2.1, Paragraph 2.6.2.2, and Paragraph 2.6.4.1 shall include removal efficiency tests from test panels with one coat of epoxy or polyurethane primer and two coats of epoxy or polyurethane topcoat air dried for seven days at room temperature and then baked for 4 days in an oven at 210° F (± 10° F). Efficiency tests from removers in Paragraph 2.6.3 and Paragraph 2.6.4.2 will be conducted on test panels with one coat of polysulfide primer (PR-1432GV) and two coats of polyurethane topcoat air dried for seven days at room temperature and then bake for 4 days in an oven at 210° F (± 10° F). Criteria for passage of the test shall be complete removal to bare metal in 15 minutes maximum for phenolic removers, one hour for nonphenolic/non-cresylic removers, and one hour using just removers listed in Paragraph 2.6.3 and Paragraph 2.6.4.2. Criteria for polysulfide primer is complete removal to bare metal in 30 minutes maximum using these same removers after the topcoat is removed using a removers listed for epoxy and polyurethane finish systems. It should be understood that removal time for a finish system which has been in service for several years is somewhat longer than for removal of the same finish system from test panels prepared as noted above. Removal time is also dependent on the number of overcoats present on the surface and environmental conditions in the removal facility.

## 2.7 GENERAL OVERALL CHEMICAL REMOVAL PROCEDURES.

Chemical removal of organic finish systems shall be performed in accordance with the following sequential steps:

### WARNING

Chemical removers are toxic to skin, eyes, and respiratory tract. Skin and eye protection required. Contact Bioenvironmental Engineering for determination of need for and selection of proper respiratory protection.

- a. Ensure that all facility safety, health, and disposal requirements and all personnel safety and health requirements in Paragraph 2.2 step a and step b are met.
- b. Determine the type of organic finish to be removed in accordance with Paragraph 2.2 step c. Select and obtain the proper chemical remover for the finish system involved in accordance with Paragraph 2.6.1, Paragraph 2.6.2, Paragraph 2.6.3, or Paragraph 2.6.4.
- c. Ensure that the removal operation has been properly planned and that all personnel understand the operation as required by Paragraph 2.2 step d.
- d. Ensure that the aircraft, equipment or component has been properly cleaned, dried, and masked in accordance with Paragraph 2.3 through Paragraph 2.3.2.1 step i.
- e. Ensure that the aircraft, equipment, or component has a surface temperature within the specified range and is located within a covered facility having an ambient air temperature within the specified range defined in Paragraph 2.3 step b.
- f. Mix the chemical remover well with a mechanical mixer or a wooden paddle immediately before use as chemical removers tend to separate on standing. Do not mix by rolling a drum of chemical remover as this will not mix the material adequately.
- g. Apply a light to medium thick, uniform coat of chemical remover to the area of the aircraft, equipment, or component from which the finish system is to be removed with a long handled, non-metallic brush, specification MIL-B-23958, (type and style are optional) or a non-atomizing type sprayer wand fitted to a barrel pump. Never use an atomized spray to apply chemical removers. Do not apply thick coats of chemical removers as this actually slows down the removal rate, creates a more extensive waste disposal operation, and wastes expensive chemical removers. Efficient removal requires maintaining a wet film of remover on the surface. Active ingredients in chemical removers listed in Paragraph 2.6.1 and Paragraph 2.6.2 are highly volatile and evaporate rapidly; so after about one hour dwell time, they begin to dry out and no longer react on the finish system as most of the active ingredients have evaporated. Environmentally compliant removers listed in Paragraph 2.6.4. have a maximum dwell time of 24 hours before they become non-reactive. For an effective removal operation chemical removers must be applied progressively and in a planned logical sequence. Apply removers to areas no larger than can be effectively worked by the personnel on hand to perform the operation. Removers should not be applied to a second area prior to completion of the removal operation in an area being worked. This is particularly important for extensive removal operations such as removal of the entire exterior finish system from an aircraft. Preferably, application of chemical removers should begin at the highest point of a vertical or sloping surface to prevent removers from running down onto surfaces from which the finish system has already been removed; but this is an optional decision to be made by local management.
- h. Allow a chemical remover listed in Paragraph 2.6.1 and Paragraph 2.6.2 to dwell on the surface undisturbed for 15 minutes, and one listed in Paragraph 2.6.3 and Paragraph 2.6.4 for 4 hours and then agitate several spots on the surface with A-A-58054, Type I, Grade C abrasive mat, or a MIL-B-23958, Type I or III brush to determine if the finish system has been loosened down to bare metal. If the finish system has loosened down to bare metal at this point, proceed to next step; if not, repeat the 15 minute or 4 hour dwell and spot agitation procedure until loosening of the finish system down to bare metal is indicated or a maximum of one hour or 24 hour dwell time has elapsed and then proceed to the next step.
- i. When the finish system has loosened to bare metal or exceeds a reasonable dwell time, thoroughly agitate the entire area on which the chemical remover has been applied with a MIL-B-23958, Type I or III brush while exerting as much pressure with the brush as possible.

**CAUTION**

- Never allow a chemical remover to dry on the surface to which it is applied as it is extremely difficult to remove after it dries.
- Never rinse surfaces with water between chemical remover applications as this stops the removal action and tends to set up the remaining finish system on the surface making it very difficult to remove. Schedule removal operations so that once started on an area, they proceed without interruption through the entire sequence to complete removal to bare metal. If the operation must be interrupted due to some scheduling problem or the workday ending, scrape off all chemical remover with a rubber bladed squeegee and rinse the area with water as directed below prior to stopping work. When a chemical removal operation is interrupted in this fashion, extreme difficulty will be encountered in removal of the remaining finish system from the area where work was stopped requiring increased amounts and applications of chemical removers, increased man-hours for the operation, and significant flow time delays. If the area is exposed to direct sunlight during the interruption, even more difficulty will be experienced in removal of the remaining finish system. Never restart chemical remover application until the area is completely dry.

**NOTE**

A MIL-B-23958, Type I, Style 1, brush is available through GSA under NSN 7920-00-054-7768 (round, nylon bristles). A MIL-B-23958, Type III, Style 1, brush is available through GSA under NSN 7920-00-051-4384 (round, nylon, and tampico bristles).

- j. Immediately after agitation, scrape all loosened finish system residue and chemical remover from the surface with a rubber bladed squeegee; and immediately reapply fresh chemical remover per Paragraph 2.7, step g, on spots where the finish system has not been removed down to bare metal in the area being worked, and repeat Paragraph 2.7, step h and Paragraph 2.7, step i.

**CAUTION**

Only those aluminum wools and brushes specified shall be used to agitate metallic surfaces during finish system removal operations. Other types of metallic wools and brushes, such as steel, copper, brass, beryllium copper, etc., shall not be used as they will either embed in or smear on the metallic surface and cause severe galvanic corrosion problems.

**NOTE**

If a polysulfide primer/polyurethane topcoat finish system is being removed and the first application of chemical remover takes off the topcoat but not the primer, the second and subsequent applications shall be with one of the chemical removers specified in this manual for removing polysulfide primer.

- k. Repeat the removal sequence, Paragraph 2.7, step g through Paragraph 2.7, step j, in the area being worked as necessary to remove the finish system down to bare metal up to a maximum of three times. For the second and all subsequent applications of chemical remover agitate the surface with A-A-58054, Type I, Grade C nylon abrasive mat; A-A-1044, Type II, Class 1, Form A, aluminum wool; and/or A-A-3118, Type I, Class A7 aluminum wire brushes to assist in the removal operation.

**NOTE**

- A-A-58054, Type I, nylon abrasive mat is available under NSN 5350-00-967-5092 for 10 sheets of Grade C (medium) material.
  - A-A-1044, Type II, Class 1, Form A, (PN AA1044-B-1-A), aluminum wool is available under NSN 5350-00-286-4851 for a one pound roll or 5350-00-312-6129 for 25 one pound rolls.
  - A-A-3118, Type I, Class 7, (PN A-A-3118/A7) aluminum wire brushes are available under NSN 7920-01-067-6192 for one brush.
- l. As soon as the finish system has been removed down to bare metal or the final attempt at overall chemical removal has been completed and the chemical remover and finish system residue has been scraped from the surface with a rubber bladed squeegee in the area being worked, flush the area thoroughly with hot water at a temperature of 100° F to 120° F and a pressure of 150-250 PSI. Start at the lowest point and work upward using care to keep the water off adjacent areas from which the finish system will be removed.

**NOTE**

- If hot water is not available, fresh tap water at hydrant pressure may be used for the flush operation. However, it should be well understood that this will make the final cleaning/washing step much more difficult and require additional man-hours and flow time to accomplish, because cold water tends to gel waxy compounds used in chemical removers and redeposit them on the surface.
  - With prior written aircraft Systems Program Director (SPD) approval, Medium Pressure Water (MPW) methods in Paragraph 2.12 (water only-no baking soda) may be used instead of Paragraph 2.7 step i through step l to enhance paint removal with environmentally compliant removers in Paragraph 2.6.4 after their required dwell time is reached.
  - When removing alkyd base primer having no topcoat, flush the area with water as soon as possible after it has been loosened by the chemical remover and scraped from the surface as it tends to readily redeposit on the surface if the surface becomes dry thus requiring another application of chemical remover.
- m. After the area being worked has been thoroughly flushed with water, remove tape used for masking within the area by hand; or, as an alternate, remove it with the hot water at the same time the area is being flushed.
- n. Remove any residual finish system from very stubborn spots and areas covered with tape during the general removal operation using care to prevent chemical removal materials from entering into and becoming entrapped in confined areas and/or causing damage to structure, components or materials. Apply either the same chemical removers used for the general removal operation, or specification MIL-T-81772, Type I or II thinner, and/or specification TT-E-751 ethyl acetate by dabbing them on the spots with a small non-metallic bristle brush. Agitate the spots with the same materials listed for agitation during the general removal operation and/or nonmetallic/plastic scrapers while the chemical remover or solvent is on the surface. Wipe the loosened finish system and chemical remover off the surface with a cotton rag; and if necessary, abrade the remaining finish system off the surface in accordance with the mechanical removal procedures in Paragraph 2.9 with materials in Table 2-1, Table 2-2, and Table 2-3. Wipe the area from which the finish system was removed with a cotton rag wetted with fresh water, and then dry with a clean cotton rag.
- o. If the area just completed is the final area from which the finish system is to be removed, proceed directly to

the next step. If other areas are to be worked, repeat Paragraph 2.7 step g through step n on the next area. Application of chemical remover on a new area may begin as soon as the flushing operation is completed and while the residual finish system removal operation is in progress on an area being worked as long as enough personnel are on hand to work both areas effectively.

- p. Immediately after finishing the chemical removal operation on the last area from which the finish system is being removed, thoroughly wash all areas of the aircraft, equipment or component from which the finish system has been removed and those adjacent areas which may have been exposed to or contaminated with chemical remover in accordance with TO 1-1-691, the aircraft -23 technical order, and/or the equipment system specific technical order. Inspect all areas where chemical remover may have become entrapped, and clean these areas as required. The aircraft, equipment or component shall not be removed from the coating removal facility until this washing operation is completed.

## 2.8 CHEMICAL REMOVAL PROCEDURES FOR CONFINED LOCATIONS.

When use of the chemical removers, listed in Paragraph 2.6.1 through Paragraph 2.6.4, of this manual is impractical because of assembly complexities and/or rinsing difficulties, remove the finish system from metal surfaces using specification MIL-T-81722, Type I or II thinner, or specification TT-E-751 ethyl acetate in accordance with the following procedures:

### **WARNING**

- Specifications MIL-T-81772, Type I or II thinner, and TT-E-751 ethyl acetate are flammable. Avoid all sources of ignition.
- Chemical removers are toxic to skin, eyes, and respiratory tract. Skin and eye protection required. Contact Bioenvironmental Engineering for determination of need for respiratory protection and selection of proper type when required.
- Use extreme caution when using specifications MIL-T-81772, Type I or II thinner, or TT-E-751 ethyl acetate in areas where liquid oxygen storage and transfer equipment are located. Never use these materials on valves, flanges or other components where they may come in direct contact with liquid oxygen or pure oxygen vapor.

### **CAUTION**

Do not allow these materials to spread to adjacent areas not being worked or to splash, overspray, or spill onto adjacent rubber, synthetic rubber, plastic, or composite materials, or components as damage to the finish system on adjacent areas and these materials and components will result.

- Apply a solvent selected from the list above to the area from which the finish system is to be removed with a small non-metallic bristle brush or a clean cotton rag.
- Allow the solvent to dwell on the surface until all the finish system to be removed has softened and/or lifted from the surface. It may be necessary to keep a rag saturated with solvent on the surface in order to keep the surface wet for the time required to lift the finish system.
- Agitate the surface at frequent intervals using the same abrasive materials and scrapers listed for agitation and residual finish system removal in Paragraph 2.7 step k and Paragraph 2.7 step n. Wipe loosened finish system residue from the surface with clean cotton rags wetted with the same solvent being used for removal.
- Repeat Paragraph 2.8 step a through Paragraph 2.8 step c as necessary until all finish system and residue have been removed from the metal surface, including recesses around rivets, bolts, etc.
- Wipe the area clean with a clean cotton rag wetted with fresh tap water, and then wipe the area dry with a clean cotton rag.

### **NOTE**

If this chemical method does not remove the finish system, proceed to one of the mechanical methods in this technical order.



## 2.9 MECHANICAL REMOVAL OF ORGANIC FINISH SYSTEMS.

### WARNING

- Reference Table 3-1 for the minimum recommended PPE for paint removal operations using hand held or motor driven abrasives (sanding and grinding). Reference Table 2-4 for the minimum recommended PPE for abrasive blasting paint removal operations.
- Abrasive blasting, motor-driven wire brush and motor-driven abrasive disc operations create airborne particles that are hazardous to the eyes, skin, respiratory tract. Do not stand above, below or directly next to other workers. Avoid being “downwind” from others using mechanical sanders and grinders. Do not use compressed air to remove dust.
- The dust created by either of these methods is hazardous to the respiratory tract, and noise produced by abrasive blasting is hazardous to the hearing. Coveralls with full-length sleeves and gloves with gauntlets shall be worn by personnel performing either of these removal methods. Protective clothing should be removed prior to leaving the work area. Personnel using motor-driven abrasives shall wear dust/particulate type respirators, goggles, and/or full face shields. Personnel performing dry abrasive blasting shall wear an abrasive blasting airline/hood respirator meeting the requirements of AFOSH STD 48-137 and hearing protection. Hoods or helmets should be cleaned prior to storage in dust-free environment. Contact the Base Bioenvironmental Engineer for specifics on required protective equipment.

- Dust generated from abrasive, metal, and finish system particles during dry abrasive blasting, motor-driven wire brush, or motor-driven abrasive disc finish system removal operations creates the potential for a dust explosion. Use only pneumatic type motor-driven equipment. Properly electrically ground all motor driven equipment, abrasive blasting equipment, work stands, and work pieces when engaged in these operations. Avoid all sources of ignition where these operations are in progress, and provide adequate ventilation in the area.
- Dry abrasive blasting, motor-driven wire brush, or motor-driven abrasive disc finish system removal on steel and titanium alloy surfaces may cause sparking. Perform these operations in a well ventilated area, and take proper fire safety precautions. If these methods are being used in a large operation involving other types of metals, remove the finish system from the steel and titanium surfaces first; and then proceed to the other areas.

### CAUTION

- Low-carbon steel brushes shall not be used on aluminum, magnesium, copper, stainless steel, or titanium alloy surfaces as steel particles will embed in these surfaces and later rust or cause galvanic corrosion of these surfaces. Copper, brass, or beryllium copper brushes shall not be used on aluminum, magnesium, steel, stainless steel, or titanium alloy surfaces as they will smear on these surfaces and cause galvanic corrosion.
- Mechanical methods shall be used only long enough to remove the finish system and not abrade the underlying metal surface. Speed of removal is not the most important factor. Removal without damage to the surface or creating a condition which can lead to future corrosion damage and providing a surface suitable for finish system reapplication are the most important factors.

- Plastic media blasting (PMB) may be used on composite materials in accordance with procedures in Paragraph 2.11, providing its use has been approved by the specific aircraft's SPD. In all cases, use PMB to remove only the topcoat from composite surfaces. The underlying primer must be used as a "flag" to signal the PMB operator that the topcoat has been removed. When the primer begins to show during the stripping operation as the topcoat is slowly removed, the PMB blast should be directed elsewhere on the surface being stripped. This technique is essential to avoid damaging the composite material.
- When using mechanical methods, abrasive blast media and pieces of broken brushes and discs can escape from the work area. These methods shall not be used in areas under conditions that allow escaped particles to enter into and damage or contaminate any system, engine, or other component. Barriers shall be erected around the work area and masking of the surrounding area and masking or plugging of all holes leading to the interior of systems and equipment shall be accomplished to prevent damage and contamination of systems and equipment by dust, abrasive blast media, and pieces of broken brushes and discs. The system specific aircraft corrosion manual (-23) or the specific equipment manual shall be consulted for proper masking requirements.

Mechanical removal methods include the use of hand-held wire brushes, bonded abrasive papers or cloths, and abrasive mats; motor-driven wire brushes, bonded abrasive paper or cloth discs, and abrasive mat discs and flap brushes; and abrasive blasting. Mechanical removal is recommended when use of chemical removers is impractical due to structural complexities and/or rinsing difficulties in an area being worked and/or local environmental restrictions. While these methods are very effective for finish system removal, they can cause severe damage to structure and equipment in a very short time if improperly used. Therefore, mechanical removal of finish systems shall be used only when specifically authorized and approved by the responsible ALC, Aircraft

System Program Director or equipment/component item manager. In addition, mechanical removal methods shall be restricted to only those areas for which they have been approved and shall be performed as directed by the instructions in this technical order.

## 2.10 MECHANICAL REMOVAL METHODS OTHER THAN PLASTIC MEDIA OR MEDIUM PRESSURE WATER BLASTING FOR METAL SUBSTRATES.

### **WARNING**

Protective clothing worn during abrasive blasting operations shall remain in the work area and shall not be taken home for cleaning.

For any and all mechanical finish system removal operations, approval for the operation shall be obtained from the responsible ALC as directed in Paragraph 2.9. The area involved in the operation shall be thoroughly cleaned to remove all oil, grease, and hydraulic fluid per TO 1-1-691. Masking shall be accomplished per instruction in Paragraph 2.3 step c and the applicable system or equipment specific manual prior to starting the operation. Precautions listed in the cautions and warnings in this manual, the applicable system or equipment specific manual, and TO 1-1-691 shall be strictly followed. Mechanical removal methods consist of hand abrasive or motor-driven abrasive removal of organic coatings from various substrate materials and abrasive blasting.

**2.10.1 Abrasive Blasting.** Iron and Steel Alloys (Other than Stainless Steel) may be abrasive blasted with aluminum oxide grit, steel grit, or sand at a maximum air pressure of 40 PSI for a pressure type machine to remove paint. This is very effective on low-carbon steels and iron as it also removes rust/corrosion leaving a bright metal surface. Use TO 1-1-691 as control for this type of abrasive blasting, and never use on steel less than 0.0625 inches thick.

**2.10.2 Hand or Motor-Driven Abrasive Removal.** These methods for mechanical removal of a finish system are basically the same for all substrates. The primary difference is the type of abrasives used, which vary depending on the



underlying surface. Table 2-1, Table 2-2, and Table 2-3 shall be used to determine the abrasive material to be used for topcoat or primer removal and the substrate metal it may be used on.

### 2.10.3 Hand Held Abrasive Removal.



- Damage to clad/Alclad or anodize surfaces will reduce the corrosion protection in those areas.
- Motor-driven wire brushes and discs and abrasive blasting shall not be used on flexible, braided copper wire, cables, hoses, and lines as these methods can cause severe damage to these components.
- Magnesium particles, powder, or dust are extreme fire hazards. Motor-driven wire brushes and abrasive flap brushes and abrasive blast media other than those listed in Table 2-1, Table 2-2, and Table 2-3 shall not be used for finish system removal from magnesium alloy surfaces. Keep work area clean. Do not permit flammable materials or any source of ignition into the area.
- Finish system removal using motor-driven abrasives can generate airborne particles that are hazardous to the skin, or respiratory tract. Work pieces and motorized equipment shall be properly electrically grounded, and personnel shall wear dust/particulate respirators, goggles, gloves, and full sleeved shirts when using motor-driven abrasives. Do not stand above, below or directly next to other workers performing these operations. Avoid being “downwind” from others using mechanical sanders. Consult Bioenvironmental Engineering Services for respiratory and ventilation requirements.

Abrade the finish system topcoat from the surface down to the primer with hand-held metallic wool, abrasive mat, abrasive cloth, or wire brushes as specified in Table 2-1 and Table 2-3. If required, change the abrasive being used and abrade the primer from the substrate material, taking care not to damage the metal substrate.

### 2.10.4 Motor Driven Abrasive Removal.

#### **WARNING**

Do not mount an abrasive on a motor driven tool having an operational speed higher than the maximum RPM rating of the abrasive. This can result in disintegration of the abrasive and can cause injury to personnel.

Abrade the finish system topcoat from the surface down to the primer with motor driven wire brushes, or either a random orbital tool or pneumatic drill motor fitted with a Roloc™ or hook and loop mounted surface conditioning disc, a disc fabricated from an abrasive cloth sheet, a Roloc™ Bristle disc, or Radial Bristle disc. Select the abrasive for use per Table 2-2 and Table 2-3. Use sanders and grinders attached to high efficiency vacuum systems for dust recovery. Use of a random orbital sander or a pneumatic drill motor fitted with the surface conditioning disc is preferable. This method provides the fastest removal rate with the least possibility of damage to the metal substrate and the longest abrasive life due to the non-loading characteristics of this type of disc. Keep sander heads flush against the surfaces being sanded and apply the least amount of pressure necessary to effectively remove the finish system topcoat and not go through the primer and gouge or abrade the metal substrate. Abrade the primer from the surface with the same methods used for the topcoat, but with finer grade abrasives per Table 2-2 and Table 2-3. Again, the motor-driven surface conditioning disc is preferred, and only enough pressure to remove the primer without gouging and abrading the metal substrate shall be applied. Always use high efficiency vacuum systems attached to the tools for dust recovery.

**2.10.5 Stainless Steel (CRES) and Nickel Based Alloys.** After completing mechanical removal using materials per Table 2-1, Table 2-2, and Table 2-3, polish the surface with hand held aluminum oxide/nylon mesh abrasive mat (very fine) or either a random orbital tool or pneumatic drill motor (12,000 RPM max) fitted with a (very fine) grade “Scotch-Brite” aluminum oxide/nylon mesh roloc or hook and loop mounted surface conditioning disc.

**2.10.6 Dust Removal.** After the finish system has been removed, use HEPA vacuums with appropriate attachments to vacuum dust from aircraft and facility floors. Do not use compressed air unless absolutely necessary to remove dust from very narrow cracks and crevices.

Table 2-1. Hand Held Abrasives

Hand Held Abrasives	Clad/Alclad and Anodized Aluminum Alloys	Non-Clad and Unanodized Aluminum Alloys	Magnesium Alloys	Iron and Steel Alloys (Other Than Stainless Steel)	Stainless Steel (CRES) and Nickel Based Alloys	Copper and Copper Based Alloys	Titanium Alloys	Fiber Glass, Arranged Fiber (Kevlar)/ Epoxy and Graphite or Boron Fiber/ Epoxy Composite Surfaces
<b>Abrasive Cloth</b>								
120 grit ANSI B74.18/GGG-C-520, Type II, Class 1	T	T	T	TP	T	T	T	T
240 grit ANSI B74.18/GGG-C-520, Type II, Class 1	P	P	P	P	P	P	P	P
<b>Abrasive Paper</b>								
120 grit ANSI B74.18/A-A-1047 silicon carbide paper	T	T	T	TP	T	T	T	T
240 grit ANSI B74.18/A-A-1047 silicon carbide paper	P	P	P	P	P	P	P	P
<b>Metallic Wool</b>								
A-A-1043, Type I, Class 1, low carbon steel wool				TP				
A-A-1043, Type I, Class 1, stainless steel wool					TP		TP	
A-A-1044, Type I, Class 1, Form A, copper wool						TP		
A-A-1044, Type II, Class 1, Form A, aluminum wool	T	T	T					
<b>Abrasive Mats</b>								
A-A-58054, Type I, Class 1, Grade A (very fine) aluminum oxide/nylon mesh					TP			
A-A-58054, Type I, Class 1, Grade B (fine) aluminum oxide/nylon mesh	P	P	P		P	P	P	P
A-A-58054, Type I, Class 1, Grade C (medium) aluminum oxide/nylon mesh	T	T	T		T	T	T	T
<b>Wire Brushes</b>								
Aluminum wire brushes (1)		TP						
Brass wire brushes (2)						TP		
Copper wire brushes (2)						TP		
Low carbon steel wire brushes (2)				TP				
Stainless steel wire brushes (1)		TP			TP		TP	

T For topcoat removal

P For primer removal

(1) Stainless steel or aluminum wire brushes shall be used on non-clad and unanodized aluminum alloys only when the structure is 0.0625 in. thick or greater.

(2) Never use brass, copper, or low carbon steel brushes on any aluminum or magnesium alloys.

Table 2-2. Motor Driven Abrasives

Motor Driven Abrasives	Clad/Aiclad and Anodized Aluminum Alloys	Non-Clad and Unanodized Aluminum Alloys	Magnesium Alloys	Iron and Steel Alloys (Other Than Stainless Steel)	Stainless Steel (CRES) and Nickel Based Alloys	Copper and Copper Based Alloys	Titanium Alloys	Fiber Glass, Arranged Fiber (Kevlar)/Epoxy and Graphite or Boron Fiber/Epoxy Composite Surfaces
<b>Roloc™ or hook and loop mounted surface conditioning discs</b>								
Very fine grade “Scotch-Brite” aluminum oxide/nylon mesh					TP			
Fine grade “Scotch-Brite” aluminum oxide/nylon mesh	P	P	P	P	P	P	P	P
Medium grade “Scotch-Brite” aluminum oxide/nylon mesh	T	T	T	TP	T	T	T	T
Roloc™ Bristle discs and Radial Bristle discs Grade 120	TP	TP	TP	TP	TP	T	TP	T
<b>Abrasive Flap Brush/Wheels</b>								
Aluminum oxide coated nylon mesh	T	TP		TP	T		T	TP
<b>Abrasive Disks</b>								
120 grit ANSI B74.18/GGG-C-520, Type II, Class 1	T	T	T	TP	T	T	T	T
240 grit ANSI B74.18/GGG-C-520, Type II, Class 1	P	P	P	P	P	P	P	P
<b>Wire Brushes</b>								
Aluminum wire brushes (1)		TP						
Brass wire brushes (2)						TP		
Copper wire brushes (2)						TP		
Low carbon steel wire brushes (2)				TP				
Stainless steel wire brushes (1)		TP			TP		TP	

T For topcoat removal

P For primer removal

(1) Stainless steel or aluminum wire brushes shall be used on non-clad and unanodized aluminum alloys only when the structure is 0.0625 in. thick or greater.

(2) Never use brass, copper, or low carbon steel brushes on any aluminum or magnesium alloys.

Table 2-3. Abrasive Materials

Item	Specification	NSN	Unit of Issue
Roloc Plastic Holder	Roloc #1 Plastic Holder	3460-01-509-1784	Case
Roloc Plastic Holder	Roloc #7 Plastic Holder	3460-01-509-1812	Case
Roloc Bristle Disk	Roloc Bristle Disk 2" x 5/8 tapered	5345-01-432-3027	Case
Roloc Bristle Disk	Roloc Bristle Disk 3" x 5/8 tapered	5345-01-432-3292	Case
Roloc Bristle Disk	Radial Bristle Disk (Thick Bristle 3"	3460-01-509-1789	Case
Surface Conditioning Disk	Scotch-Brite Surface Conditioning Disk 2"	5345-01-367-7680	Box
Surface Conditioning Disk	Scotch-Brite Surface Conditioning Disk 3"	5345-01-397-5256	Box
Metallic Wool carbon steel	A-A-1043, Type III, Class 1	5350-00-242-4404	1 each, 1 lb roll
Metallic Wool stain. steel	A-A-1043, Type IV, Class 1	5350-00-440-5035	1 each, 1 lb roll
Metallic Wool aluminum	A-A-1044 Type II, Class 1 Form A	5350-00-286-4851	1 each, 1 lb roll
Metallic Wool aluminum	A-A-1044 Type II, Class 3 Form A	5350-00-312-6129	1 each, 1 lb rolls
Metallic Wool copper	A-A-1044, Type I, Class 1, Form A	5350-00-255-7736	1 each, 1 lb roll
Abrasive Mat	A-A-58054, Type I, Class 1, Grade A	5350-00-967-5089	10 each, 9 in x 11in sheets
Abrasive Mat	A-A-58054, Type I, Class 1, Grade B	5350-00-967-5093	10 each, 9 in x 11in sheets
Abrasive Mat	A-A-58054, Type I, Class 1, Grade C	5350-00-967-5092	10 each, 9 in x 11in sheets
Abrasive Cloth silicone carbide	120 grit ANSI B74.18/GGG-C- 520, Type II, Class 1	5350-00-865-5689	25 each, 9 in x 11in sheets
Abrasive Cloth flint/emery	240 grit ANSI B74.18/GGG-C, 520, Type II, Class 1	5350-00-174-0999	25 each, 9 in x 11in- sheets
Abrasive Paper silicone car	120 grit ANSI B74.18/A-A-1047	5350-00-721-8115	50 each, 9 in x 11in sheets 5
Abrasive Paper silicone car	240 grit ANSI B74.18/A-A-1047	5350-00-224-7207	50 each, 9 in x 11in sheets

Table 2-4. Minimum Recommended Controls and PPE for Abrasive Blasting Operations<sup>a</sup>

Operation	Engineering Controls	Personal Protective Equipment						
		Respiratory	Hand	Ear	Eye	Body	Foot	
Masking	None	None	None	None <sup>b</sup>	None	None	Safety toe boots	
Refilling of blast media	None	None	None	None <sup>b</sup>	Safety goggles or faceshield	Tyvek or cotton coveralls	Safety toe boots	
Abrasive blasting	Abrasive blast enclosure	Blasting helmet with supplied-air	Leather and disposable nitrile gloves	Ear Plugs	None	Tyvek or cotton coveralls; leather shoulder cover <sup>c</sup>	Safety toe boots	
Dust removal (compressed air)	Abrasive blast enclosure	Blasting helmet with supplied-air	Leather and disposable nitrile gloves	Ear Plugs	None	Tyvek or cotton coveralls	Safety toe boots	
Dust removal (vacuum)	HEPA vacuum	None	None	Ear Plugs <sup>d</sup>	None	Tyvek or cotton coveralls	Safety toe boots	
Media clean-up	HEPA vacuum	None	None	Ear Plugs <sup>d</sup>	None	Tyvek or cotton coveralls	Safety toe boots	

<sup>a</sup> Local Bioenvironmental Engineer may recommend more restrictive controls

<sup>b</sup> Hearing protection may be required in locations where hazardous noise is produced

<sup>c</sup> A Powered Air-Purifying Respirator (PAPR) with hood is the best choice

<sup>d</sup> Not required if a full-facepiece or hooded respirator is worn

2.11 PMB REMOVAL METHOD.

PMB is an excellent and rapid method for finish system removal, but it can cause severe damage to structure and injury to personnel if not done properly with the right type of equipment in the an approved facility. In addition, proper waste management must be ensured for economic and environmental reasons. Some types of materials and material thicknesses cannot be plastic media blasted under any circumstances. Therefore, PMB is authorized at depot and field level operations contingent upon SPD approval of facilities, personnel training, and processes as specified in system or item specific technical data. These instructions are not intended to be all inclusive, but are general requirements to be used in conjunction with additional instructions in applicable system peculiar aircraft or equipment manuals. All PMB finish removal operations shall conform to the following requirements:

2.11.1 Media Type. Media used in PMB shall be fabricated from plastic stocks which are free from high-density particle contamination and other impurities. The plastics used shall be of a specific, non-changing chemical composition as specified in MIL-P-85891, Plastic Media, For Removal of Organic Coatings, and paragraphs below. Media used shall have a particle size of U.S. screen 20 to 40 mesh; however, 12 to 16 mesh may be added as make up media. The media shall have a particle shape which is irregular with sharp, angular edges and corners. Plastic media is classified by type which specifies the hardness and plastic and, therefore, the performance characteristics. The following are the definitions of media types as specified by MIL-P-85891:

2.11.1.1 Type I. A polyester plastic with a 3.0 MOH (34 to 42 Barcol) hardness and the least damaging of all media types. This media is recommended for use on aerospace equipment and shall be used if a 1/2 square foot per minute strip rate can be maintained under the aerospace stripping parameters listed in Paragraph 2.11.3.

2.11.1.2 Type II.



The Type II media is more aggressive than the Type I media and will induce greater residual stresses in the underlying metals if used improperly. Increased residual stresses can cause warping and increased crack growth rates in aircraft skin materials and ground equipment enclosures.

A Urea Formaldehyde based plastic with a 3.5 MOH (54 to 62 Barcol) hardness. This media may be used on aerospace equipment if and only if the Type I material produces less than a 1/2 square foot per minute strip rate under the parameters listed in Paragraph 2.11.3. Parameters for the proper use of Type II media on aerospace structures are also listed in Paragraph 2.11.3. Type II media is recommended for

use on non-aerospace equipment such as SE. For non-aerospace use blast pressure shall not exceed 50 PSI on materials at least 0.040 inches thick. The nozzle shall be held at least 12 inches from the material to be stripped.

2.11.1.3 Type III. A Melamine Formaldehyde Plastic with a 4.0 MOH (64 to 74 Barcol) hardness. This Type III media is not authorized for use in stripping aerospace structures. Type III media is very aggressive and is recommended only for stripping iron based equipment where residual stress problems will have no consequences. This material is authorized for use on SE and other non-aerospace applications where the metal is at least 0.0625 inches thick. Blasting pressure should not exceed 40 PSI at the nozzle. The nozzle shall be held at least 12 inches from the material to be stripped.

2.11.1.4 Type IV. A Phenol Formaldehyde Plastic with a 3.5 MOH (54 to 62 Barcol) hardness. Type IV is not authorized for blasting of aerospace structures. Type IV may be used on SE and on other non-aerospace equipment. Blast parameters are the same as for Type II.

2.11.1.5 Type V. An Acrylic Plastic with a hardness of 3.2 MOH (49 to 57 Barcol) hardness. This media is authorized for use on aerospace systems as well as non-aerospace applications. Blasting parameters: pressure 25-40 PSI; stand-off distance 12 in - 24 in; angle (alclad and composites) 0 - 60 degrees; angle (nonclad) 30 - 90 degrees.

2.11.1.6 Type VII. A Starch-g-Acrylic with a hardness of 72 to 79 (Shore D hardness). This material is authorized for use on aerospace systems and non-aerospace equipment applications. Blasting parameters: nozzle pressure 45 PSI; standoff distance 12 in - 24 in; angle 0 - 60. This media is very moisture sensitive and the air flow shall be dry and oil free.

2.11.2 Media Authorized for Air Force Use. Plastic media, while meeting the above criteria, can vary from manufacturer to manufacturer. The medias listed below have been tested and meet Air Force requirements and first article requirements of MIL-P-85891 and are authorized for use on aerospace and non-aerospace structures (where authorized by the SPD). The authorized media supplies are:

<b>Type II</b>	<b>Manufacturer</b>
	BIP Limited (BIP Plastics, Inc.)
	Urea (Type II) BIP (ABMU2030)
	PO Box 3180
	Popes Lane
	Oldbury Warley
	United Kingdom B69 4PG
	Cage Code: U4645



Composition Materials Co., Inc  
 Urea (Type II)  
 125 Old Gate Lane  
 Milford, CT 06460-3611  
 Cage Code: 98231

Patent Plastics Inc (MPC, Inc.)  
 Urea (Type II)  
 P.O. Box 9246  
 638 Maryville Pike SW  
 Knoxville, TN 37920-3962  
 Cage Code: 1GM63

Opti-Blast Inc.  
 T-2 Mil Spec, Urea (Type II)  
 4032-B N Jackson St.  
 PO Box 2079  
 Jacksonville, TX 75766-2079  
 Cage Code: 08PL5

Poly-Pacific Technologies Inc.  
 4755 Zinfandel Court Unit A  
 Ontario, CA 91761-2330  
 Cage Code: 1Y3D6

Solidstrip, Inc / Composite Leasing  
 Inc.  
 DBA Solidstrip Plastic Abrasives  
 Solidstrip Urea Type II  
 P.O. Box 102  
 8618 Hwy 51  
 North Minocqua, WI 54548-0102  
 Cage Code: 0V5J2

US Technology Corporation  
 Poly Plus (Type II)  
 1446 West Tuscarawas Street  
 Canton, OH 44702-2038  
 Cage Code: 1AM56

Mac'ants Abrasives Limited  
 Todwick Road  
 Dinnington, Sheffield  
 England, S25 3SE  
 Cage Code: Unknown

Abrasive Supply Co., Inc. / Ziroc-  
 blast SDN.BHD  
 Urea (Type II)  
 25240 State Route 172  
 Minerva, OH 44657  
 Cage Code: Unknown

**Type III**

**Manufacturer**

Patent Plastics, Inc. (MPC, Inc.)  
 638 Maryville Pike SW  
 Knoxville, TN 37920-3962  
 Cage Code: 1GM63

Solidstrip, Inc / Composite Leasing  
 Inc.  
 DBA Solidstrip Plastic Abrasives  
 Solidstrip Melamine Type III  
 PO Box 102  
 8618 Hwy 51 North  
 Minocqua, WI 54548-0102  
 Cage Code: 0V5J2

Abrasive Supply Co., Inc. / Ziroc-  
 blast SDN.BHD  
 Melamine (Type III)  
 25240 State Route 172  
 Minerva, OH 44657  
 Cage Code: Unknown

**Type V**

**Manufacturer**

MPC Inc. / Patent Plastics Inc.)  
 P.O. Box 9246  
 638 Maryville Pike SW  
 Knoxville, TN 37920-3962  
 Cage Code: 1GM63

Opti-Blast Inc  
 T-5 Mil Spec, Acrylic (Type V)  
 PO Box: 2079  
 4032-B N Jackson St  
 Jacksonville, TX 75766-2079  
 Cage Code: 08PL5

Poly-Pacific Technologies Inc.  
 4755 Zinfandel Court Unit A  
 Ontario, CA 91761-2330  
 Cage Code: 1Y3D6

Solidstrip, Inc. / Composite Leasing  
 Inc.  
 DBA Solidstrip Plastic Abrasives  
 Solidstrip (Acrylic) Type V  
 P.O. Box 102  
 8618 Hwy 51 North  
 Minocqua, WI 54548-0102  
 Cage Code: 0V5J2

U.S. Technology Corporation  
 Poly V (Type V)  
 1446 West Tuscarawas Street  
 Canton, OH 44702-2038  
 Cage Code: 1AM56

Composition Materials Co., Inc.  
 125 Old Gate Lane  
 Milford, CT 06460-3611  
 Cage Code: 98231

Mac'ants Abrasives Limited  
 Todwick Road  
 Dinnington, Sheffield  
 England, S25 3SE  
 Cage Code: Unknown

Abrasive Supply Co., Inc./Ziroblast  
 SDN.BHD  
 Acrylic (Type V)  
 25240 State Route 172  
 Minerva, OH 44657  
 Cage Code: Unknown

**Type VII Manufacturer**

Archer Daniel Midland  
 E-Strip GP (Type VII)  
 995 Mill Street  
 Montreal, Quebec H3C 1Y5  
 Cage Code: Unknown  
 Phone: 514-846-8516

2.11.2.1 All media shall be tested for contamination per Paragraph 2.11.3.

2.11.3 Operational Parameters for Metallic Surfaces. All PMB operations on metallic surfaces shall conform to the following parameters:

2.11.3.1 Pressure shall be within the range of 40 to 60 PSI at the blast nozzle for 3.0 MOH hardness media (Type I), 25

to 40 PSI at the nozzle for 3.2 MOH hardness media (Type V), and 20 to 30 PSI at the nozzle for 3.5 MOH hardness media (Type II). See Paragraph 2.11.1 for recommended parameters for stripping AGE and vehicles.

2.11.3.2 The blast nozzle tip to work surface standoff distance shall be within the range of 12 to 24 inches for 3.0 MOH hardness media (Type I), 12 to 24 inches for 3.2 MOH hardness media (Type V), and 18 to 30 inches for 3.5 MOH hardness media (Type II). See Paragraph 2.11.1 for recommended parameters for SE and vehicles.

2.11.3.3 The angle of incidence between the blast nozzle and the work surface shall be within the range of 30 to 90 degrees for 3.0 MOH hardness media (Type I), 30 to 90 degrees for 3.2 MOH hardness media (Type V), and 0 to 60 degrees for 3.5 MOH hardness media (Type II). SE and vehicles may be stripped at any angle.

2.11.4 Usage Restrictions. PMB shall not be used on metal structures having a thickness less than 0.016 inch for 3.0 MOH and 3.2 MOH hardness media (Type I and V) and 0.032 inch for 3.5 MOH hardness media. See Paragraph 2.11.1 for portions pertaining to SE and vehicles.

**NOTE**

When blasting close to masking on the work surface, the nozzle shall be held as close as possible to 90 degrees with the work surface to prevent undercutting of the masking materials.

2.11.5 Operational Parameters for Non-Metallic (Composite) Surfaces. All PMB operations on non-metallic surfaces (fiberglass, kevlar/epoxy, graphite/epoxy, boron/epoxy, etc.) shall conform to the following parameters:

2.11.5.1 Pressure shall be within the range of 30 to 60 PSI at the blast nozzle for the 3.0 MOH hardness media (Type I) and 25 to 40 PSI for the 3.5 MOH hardness media (Type II) and the 3.2 MOH hardness media (Type V).

2.11.5.2 The blast nozzle tip to work surface standoff distance shall be within the range of 12 to 24 inches.

2.11.5.3 The angle of incidence between the blast nozzle and the work surface shall be within the range of 40 to 60 degrees.

**CAUTION**

- When using the PMB method of paint removal on non-metal (composite) surfaces, it is important to limit the amount of time the surface is exposed to the PMB blast. To limit this “dwell time” and still allow paint to be removed, operators should use the primer coat as a “flag.” That is, when the primer begins to become visible, the PMB blast should be aimed at another section of the surface to be stripped. This results in all paint being removed and only a portion of the primer. Most importantly, limiting the dwell time prevents damage to the composite material being stripped.
- To minimize dwell time, avoid “low pressure-long standoff distance-shallow angle” combination of parameters.

2.11.5.4 To maintain a constant removal rate and limit the amount of time which the PMB blast impinges on any given surface (dwell time), the following relationships are important to remember:

2.11.5.5 As stand off distance increases (decreases), pressure should increase (decrease) to maintain a constant removal rate.

2.11.5.6 As the angle of incidence decreases towards 0° (increases towards 90°), the pressure should increase (decrease) to maintain a constant removal rate.

2.11.6 Operation Safety Requirements. Proceed as follows.

- a. Keep all sources of ignition a minimum of 50 feet away from the area when PMB is in progress.
- b. All blasting equipment, work stands, and the aircraft, equipment, or components being blasted shall be properly electrically grounded per TO 00-25-172 and the applicable aircraft or equipment manual during the entire PMB operation.
- c. All power shall be removed from the aircraft or equipment while PMB is in progress.
- d. Titanium and steel alloy surfaces will spark when subjected to PMB. When a PMB operation involves a combination of these and other metals, the titanium and steel alloy surfaces shall be blasted first and then the other metal surfaces.
- e. The facility used for PMB shall have adequate air flow and ventilation to prevent build up of an explosive dust mixture. The Base Bioenvironmental Engineer shall be consulted for proper ventilation requirements. For additional reference criteria, see the Air Force Corrosion

Facility Reference Guide on the Air Force Corrosion Prevention and Control office’s website.

- f. Personnel involved in PMB shall wear coveralls with full length sleeves, gloves with gauntlets, and full air supplied respirator type hoods and hearing protection which meet AFOSH STD 48-137 requirements. Hoods shall be put on prior to entering the blasting area and shall not be removed until after exiting the blasting area. Hoods shall be stored in a clean dust free area and shall be cleaned to remove all dust accumulations on them prior to storage after use. All personnel entering the blasting area while PMB is in progress, even though not involved in the operation, shall comply with these personnel protection requirements. The Base Bioenvironmental Engineer and Base Fire Department will define the PMB blasting area when the PMB equipment is located within a larger facility and is not segregated from other areas. Protective clothing worn during PMB shall remain in the work area and shall not be taken home for cleaning.
- g. Blast nozzle operators shall never direct a nozzle at other personnel. If more than one blast nozzle operator is involved in an operation at the same time, they shall be located on opposite sides and/or ends of the aircraft or equipment being blasted to ensure safe separation of personnel.
- h. Dust and media residue generated during PMB operations create very slippery conditions. Walking on top of aircraft or equipment during PMB operations shall be avoided if at all possible, and shall be done with extreme caution by personnel wearing fall protection devices if it is absolutely required by the operation. All work stands shall be equipped with guard rails to prevent falls.

2.11.7 Personnel Qualifications. PMB shall be performed only by personnel thoroughly trained in the operation of PMB equipment and thoroughly indoctrinated in PMB requirements and techniques specified in this technical order and any other system peculiar aircraft or equipment technical order applicable to the job to be performed.

2.11.8 Pre-blast Preparation. Proceed as follows.

- a. Prior to masking for PMB, thoroughly clean the aircraft, equipment, or component per TO 1-1-691 to remove all grease, oil, hydraulic fluid, and dirt from surfaces to be blasted. Every effort shall be made to stop all fluid leaks noted at this time. Surfaces shall be allowed to fully dry prior to masking and input of the item into the blasting facility. Water and other fluids contaminate blasting media and may damage separation equipment.
- b. Prior to starting PMB, properly mask the aircraft, equipment, or component to prevent blast media and dust from penetrating into interior areas and causing contamination or damage to equipment, systems, or structure susceptible to damage by media impingement. Masking shall be accomplished in accordance with

instruction in Paragraph 2.3 step d of this technical order and the applicable system specific aircraft or equipment technical order for the item being blasted such as the aircraft system specific -23 manual.

**2.11.9 Postblast Cleaning.** When the finish system has been completely removed by PMB, thoroughly vacuum all surfaces of the aircraft, equipment, or component with a heavy duty, pneumatic type, wet/dry HEPA filtered vacuum cleaner to remove all finish system dust and media residue. As an alternative, compressed air or water wash may be used to remove dust and media residue. However, avoid the use of compressed air to remove dust and media residue, unless absolutely necessary. Masking shall be removed, and interior areas and crevices which were masked or plugged to prevent dust and media entry shall be inspected for presence of dust and media particles and vacuumed clean as necessary.

#### NOTE

PMB media has an anti-static additive that tends to contaminate the blasted surface and inhibit paint adhesion. Solvent wiping is required in addition to washing to completely remove this residue.

**2.11.10 Specific Technical Data and Work Directives.** Prior to initiating any PMB finish system removal operation on any aircraft, component, or piece of equipment, each aircraft SPD or equipment item manager (XX-ALC/XX) shall prepare detailed work specifications or project directives that outline masking instructions and blasting instructions. These instructions shall conform to all requirements in this TO and the applicable system specific aircraft or equipment TO. Finally, a detailed step by step process order or work control document that complies with all the technical data and work specification or project directive requirements shall be prepared by the maintenance organization or contractor for each separate PMB finish system removal operation.

**2.11.11 Disposal of Plastic Media Used in Paint Removal Operations.** Disposal of used media must be coordinated with the proper local base agency due to the contamination of the media. The resulting contamination from most paint removal operations makes the plastic media a hazardous waste that must be disposed of properly.

**2.11.12 Contamination Testing of Plastic Media.** Plastic media shall be tested for contaminants as specified in the following paragraphs. The media used in PMB equipment for paint removal of aircraft and aircraft components shall be sampled and tested every 80 hours of equipment operation time or after each aircraft or large piece of aerospace equipment is blasted (whichever is longer). Non-aerospace equipment such as SE and vehicles are less sensitive to damage from media contamination, so media used to strip these items shall be tested for contamination every 800 hours of equipment operation. Plastic media that is being used to blast steel/ferrous items for paint removal or other coatings removal shall not be used on a aluminum aircraft surfaces or

components. Media found to have a high-density particle contamination level greater than that specified in Paragraph 2.11.12.1 shall be purged from the system and replaced with new media. Testing at the ALCs shall be accomplished in the physical sciences laboratory (XX-ALC/MAD). Testing at contractor and field level activities shall be accomplished locally in a designated area adequately equipped to run the test for contamination. Organizations using PMB coatings removal processes in small walk-in or cabinet-type booths are given an option to either test media as specified in the paragraphs that follow, or forego PMB testing and purge the used media and replace it with new media at intervals not to exceed 80 hours of equipment operation when used on aircraft components, or 800 hours of operation when used on non-aerospace equipment. This option is not applicable to large-scale PMB coatings removal operations where entire aircraft or large subassemblies, such as wings or horizontal/vertical stabilizers, are completely stripped.

**2.11.12.1 Equipment and Materials Recommended:**

- One 500 milliliter separatory funnel
- Rod stand, for separatory funnel
- Holding rings, for funnels
- Perfluorohexane, (SG 1.68), 3M Company PN PF-5060TM or equivalent
- ASTM D1836 N-Hexane (Adhesive Thinner), NSN 8040-00-853-8913 for a 1 gallon can (SG 0.66)
- One glass funnel, 3 inch nominal diameter
- One glass powder (large stem) funnel, 4-inch nominal diameter
- Whatman number 42 (or equal) filter paper, 12.5 cm, to fit above funnel
- Scales, 1000 grams capacity, 0.1 gram sensitivity such as:
  - Ohaus E4000, 0 - 4000g, 0.1g
  - Sartorius U3600, 0 - 3600g, 0.1g
  - Ohaus GT2100, 0 - 2100g, 0.01g
- Analytical balance, 100 grams capacity, 0.001 gram sensitivity such as:
  - Ohaus E120G, 0 - 120g/0.001g,
  - Sartorius H120, 0 - 120g/0.001g
  - Metler AB-160, 0 - 160g/0.0001g
  - Metler PM200, 0 - 210g/0.001g
  - Metler AT200, 0 - 205g/0.0001g
- Special dual range balances offering bulk weighing and precision weighing in a single instrument may be substituted for the above instruments, but usually they have limited capacity and significantly higher prices. Two are:
  - Metler PM480 DeltaRange, 80g/0.001g, 410g/0.01g
  - Melter AT460 DeltaRange, 62g/0.0001g, 405g/0.001g
- 500-600 ml tall form Pyrex beaker

## TO 1-1-8

250 ml Pyrex beaker  
500-ml graduated glass cylinder  
Two jug-type glass storage bottles, gal, with screw caps  
Hydrometer, 1.60 - 1.80 specific gravity  
Pyrex watch glass, 75 - 90mm dia  
Nalgene polyethylene wash bottles, 250 ml  
Bar magnet  
Spatula, stainless steel  
Glass stirring rods, 10 inch  
Neoprene gloves, size as required such as: Playtex neoprene.

### NOTE

Laboratory equipment may be purchased from national laboratory supply firms such as Fisher Scientific, VWR Scientific, Curtin Matheson Scientific, or from local laboratory supply firms found in most large cities.

2.11.12.2 Sampling Procedure. Collect approximately two liters of used media, preferably from the blast pot or hose.

2.11.12.2.1 Used Media. The best representative sample is obtained by collecting media directly from the blast nozzle; but if this is not feasible, collect the sample from media hoppers located after separation equipment in recovery/reclamation system.

2.11.12.3 Contamination Test Procedure. Proceed as follows

- a. Ensure all glassware is clean and dry.

### WARNING

Keep solvents away from heat and open flame. Keep containers closed. Use only with adequate ventilation. Avoid prolonged or repeated contact with skin and swallowing.

- b. Prepare a mixture of 95% by volume Perfluorohexane (SG 1.68), 3M Company PN PF-5060TM, and 5% by volume ASTM D1836 N-Hexane (SG 0.66). To make mixing easier, pour the N-Hexane into the container first, and then add the PF-5060TM fluid. Using a hydrometer, measure the specific gravity (SG) of the mixture to ensure it is within the range of 1.60 to 1.66. If the SG is below 1.60 add a small amount of PF-5060TM until the SG is within range; if the SG is above 1.66, add very small amounts of N-Hexane until the SG is within range. This fluid mixture is to be used in testing for high density particle contamination of used media. The SG of this fluid mixture is high enough to float the light plastic media particles while allowing high density particles to separate and settle out. A quantity of this test fluid mix may be prepared in advance and stored until needed in small necked, tightly capped bottles marked with the value of the SG of the fluid they contain.
- c. Add approximately 300-350 ml (bulk dry volume) of sample media to 500 ml beaker. Weigh beaker and media to the nearest tenth gram (0.1 gm) and record (Weight #1) gross weight. Pour media into 500 ml separatory funnel (stopcock closed) and ensure there is no spillage. Obtain tare weight of 500 ml beaker and record (Weight #2) to the nearest tenth gram (0.1 gm).
- d. Add the fluid to separatory funnel leaving some air space in the funnel for ease of agitation. Swirl the mixture. A swirling motion is better than shaking to reduce entrainment of air and suspension of particles due to energy of motion of the moving fluid. Media samples may contain some dust-sized particles, which may be suspended in the fluid after agitation and adhere to the sides. Tapping the side of the funnel should dislodge any particles adhering to the sides. Place the separatory funnel on the rod stand using the holding ring. Allow 10 minutes for the suspended dust to settle or rise. Higher density particles will accumulate in the bottom of the separatory funnel on top of the stopcock.
- e. Fold the filter paper in a standard filter fold and place it in a funnel. Position the funnel in a holding ring on the rod stand beneath the separatory funnel and place a beaker beneath this funnel to catch the test fluid. Use short duration opening of stopcock in order to drain higher density particles settled out in the bottom of separatory funnel (on top of stopcock) into filter funnel.



Tapping the side of the separatory funnel may help to remove the high-density particles. Do not allow fluid level to get too low, because it might allow some floating media to be deposited with the high-density contaminants. Additional fluid may be added to separatory funnel taking care not to agitate mixture. If agitation occurs, allow 10 minutes for suspended dust particles to float/settle prior to continuation. To separate all of the high-density particles, the process has to be repeated until no particles will separate out of the plastic media. One attempt will not extract them all.

- f. Place the filter and filtrate in a vented, dust free location (preferably, a laboratory hood) to dry for one hour. Weigh the filter paper and filtrate to 0.001 gm precision. Allow the filter paper to dry an additional 30 minutes and reweigh. If there is a change greater than 0.001 gm, continue to dry the sample, checking the weight every 30 minutes until the weight between intervals does not change. Obtain the tare weight of a watch glass, or on an electronic balance so equipped, and reset the balance to 0 with the watch glass on the pan. Carefully remove the filtrate from the filter paper onto the watch glass by tapping. Unfold the filter paper and remove the remaining particles with a hard instrument, such as a metal spatula, until no visible sign of particles remain. Do not use a brush. Fine particles or dust may have impregnated the filter paper. This residue is not a major concern and may be disregarded because fine particles (less than 80 mesh, US Standard Sieve) are not damaging to aircraft materials or structure. Depending upon the balance used, weigh or calculate the weight of the dense particles to 0.001 gm precision and record as Weight #3. (Gross weight minus weight of watch glass). After weighing use a magnet to determine if any steel/ferrous material is in the dense particles. This information may help in determining the source of the contamination and facilitate process troubleshooting. However, the 0.02% dense particle contamination level in Paragraph 2.11.12.3 (i) is the basis for acceptance or rejection of the media regardless of the contamination composition.
- g. Filter the used test fluid mixture through a funnel with clean filter paper, and retain for reuse. Store in a separate, small-neck, tightly closed and properly labeled container. Recheck specific gravity with a hydrometer to assure it is in the proper range prior to reuse.
- h. Calculations: Gross weight of media and 500 ml beaker (Weight #1) minus tare weight of 500 ml beaker (Weight #2) equals net weight of media, and weight #3 is the dense particle weight. The dense particle weight divided by the media weight equals the weight fraction of dense particles in the sample. Multiply the weight fraction by 100 to find the weight percent of dense particles in the sample.

$$\frac{\text{Dense Particles Wt}}{\text{Media Weight}} \times 100 = \text{Percent}$$

- i. Sand, concrete, and glass particles tend to cause pitting and the most fatigue life degradation while steel/ferrous particles will pit and embed in softer aluminum and magnesium substrates. The high density particle contaminant level shall not exceed 0.02% for all used media employed in aerospace equipment stripping operations. For non-aerospace equipment (SE, vehicles, etc.) stripping operations, the high density particle contamination level shall not exceed 2.0% for used media.

## 2.12 MPW REMOVAL METHOD.

This removal method requires the use of a medium-pressure water and bicarbonate of soda injection system with control, hoses, and handheld nozzles of various configurations. The injection system shall consist of a positive feed control system, such as an auger/computer controlled system. This MPW removal system, with or without abrasives is an excellent method for finish system removal, but can cause severe damage to structure and injury to personnel, if not done properly. MPW paint removal is authorized at depot and field-level operations subject to SPD approval of facilities, equipment, personnel training, and technical data. These instructions are not intended to be all inclusive, but are general, necessary guidelines to be used in conjunction with additional instructions in applicable system-peculiar aircraft or equipment manuals and a definitive process order. All MPW removal operations shall conform to the following requirements:

### NOTE

Only the equipment and supplies listed below have been approved for Air Force use. The medium-pressure-water equipment are the E25M Electric Unit, NSN 4940-01-413-5627/4940-01-395-9471; the D44 Diesel Unit, NSN 4940-01-411-9826/4920-01-413-5629, and the B-25 Electric Unit (least expensive basic unit), NSN 4940-01-451-0020, all without rotating gun. For a portable unit, a trailer NSN 4940-01-413-5602 can be used. It is recommended that the repair kit Model 900-005, NSN 4940-01-411-9829 be bought with the blast equipment. The bicarbonate of soda blasting media is available in 40-pound bags under NSN 5350-01-414-1894.

### 2.12.1 Preparation. Proceed as follows.

- a. Prior to masking for MPW paint removal, the aircraft and other equipment shall be defueled and purged. In addition, if deemed necessary, the aircraft or extremely contaminated areas on the aircraft shall be washed in accordance with TO 1-1-691.
- b. Before starting the MPW paint removal operations, the aircraft, equipment, or component shall be properly masked and sealed to prevent water or bicarbonate of soda blast media from penetrating into interior areas and



causing contamination or damage to equipment, systems, or structure. All surfaces where tape is to be applied shall be wiped down with isopropyl alcohol, TT-I-735 or acetone, O-A51/ASTM D 329. The solvent used during the wipe down operation shall not be allowed to evaporate from the surface, but shall be wiped from the surface with a dry, clean cloth. Masking shall be accomplished according to instructions in Paragraph 2.3 step c and step d of this technical order and the applicable system-peculiar aircraft or equipment technical order for the item being stripped, such as the aircraft system-peculiar -23 corrosion manual or the definitive process order. In addition to masking and sealing such areas as fiberglass components, windows, radomes, and composite structures, drain holes shall be plugged prior to stripping.

- c. Areas which are covered by the barrier tape may be hand stripped with an environmentally compliant chemical remover prior to masking for the complete paint removal operation provided the procedures in this technical order are strictly followed. Narrow seams around emergency doors, hatches, entry doors, and other doors on the aircraft shall be protected from the blast stream.

**2.12.2 Paint Removal Operations.** All MPW paint removal shall conform to the following parameters:



- Bicarbonate of soda blast media shall not exceed one half pound per minute on the exterior of any aircraft.
  - It is very important to prevent intrusion of the bicarbonate of soda blast media in areas where it can become entrapped in the aircraft structure. It may become corrosive if left within the aircraft structure. A thorough inspection for media intrusion shall be performed and a thorough rinsing with hot water after blasting shall be accomplished to prevent media from being retained in the aircraft.
- a. The MPW equipment shall have the following operating parameters: water pressure of 15,000 PSI; water flow rate of 3 GPM, bicarbonate of soda blast media flow rate 1/4 to 1/2 lb per minute.
  - b. The nozzle stand-off distance shall be within the range of 2 to 4 inches from the tip of the nozzle to the working surface.
  - c. The angle of incidence between the nozzle and the work surface shall be within the range of 40 to 60 degrees (measured from the surface being stripped).

- d. In order to limit the amount of time the medium pressure water and abrasive strikes or hits any given surface (dwell time) and prevent possible damage, the nozzle shall be moved across the surface at a minimum rate of 4 inches every second.

**2.12.3 Post-Paint Removal Cleaning.** Proceed as follows.

- a. When the finish system has been completely removed by the MPW method, all surfaces of the aircraft, equipment or component shall be rinsed with hot water (not to exceed 140° F) to remove all media residue.
- b. Remove masking and sealing materials and, if necessary, hand clean protected areas. Allow entire area to thoroughly dry. Open and flush all covers and/or crevices to eliminate media residue. The aircraft, equipment, or component shall be thoroughly washed in accordance with TO 1-1-691.

**2.12.4 Operational Safety Requirements.** The following is required for safety.

- a. All sources of ignition shall be kept a minimum of 50 feet away from the area when MPW paint removal is in progress.
- b. All MPW equipment, work stands, and the aircraft, equipment, or components being stripped shall be electrically grounded per TO 00-25-172 and the applicable aircraft or equipment manual during the entire paint removal operation.
- c. All power shall be removed from the aircraft or equipment while MPW paint removal is in progress.
- d. The facility used for MPW paint removal shall have adequate air flow/ventilation. The Base Bioenvironmental Engineer shall be consulted for proper ventilation requirements.
- e. Personnel involved in MPW paint removal shall wear ear plugs, ear muffs, goggles, or full face shield, wet-weather suit, water-resistant hoods, chemical-resistant boots, and shin and instep guard assemblies. The shin and instep guard assembly shall be puncture resistant aluminum with a 5 inch wide by 6 inch long instep section attached by a hinge assembly to a shin section of at least 20 inches in length. Ellwood Safety Appliance Co. Model No. 3235P is one product that meets these requirements. All personnel entering the removal area while MPW stripping is in progress, even though not involved in the operation, shall also comply with these personnel protection requirements. The local base Bioenvironmental Engineer shall define the MPW paint removal area when the MPW equipment is located within a larger facility and is not segregated from other

areas. Protective clothing worn during water stripping shall remain in the work area and shall not be taken home for cleaning.

- f. MPW nozzle operators shall never direct a nozzle at other personnel. If more than one MPW nozzle operator is involved in an operation at the same time, they shall be located on opposite sides and/or ends of the aircraft or equipment being stripped to ensure safe separation of personnel.
- g. Water and media residue generated during paint removal operations can create a slippery condition. Walking on top of aircraft or equipment during paint removal operations shall be avoided, if at all possible, and shall be done with extreme caution by personnel wearing fall protection devices. All work stands shall be equipped with guardrails to prevent falls.

2.12.5 Personnel Qualification. Several methods of training may be used for initial and follow on MPW training.

2.12.5.1 Equipment manufacturer's training. This training may consist of on-site training or video training. Regardless of the method, it is essential the individual receives and understands the training given through a practical, locally developed certification method.

2.12.5.2 Air Force supplied local training. A unit level training program can be developed to include general instructional information on operation and safety. This should be followed by hands on practical training in performing MPW using all appropriate safety equipment. This would be the minimum requirements for operator certification.

## 2.13 REMOVAL OF THERMOPLASTIC POWDER COATING.

2.13.1 Removal Procedures. Thermal spray coating resins are difficult to remove by medium pressure abrasive grit blasting; but grit blasting, scrapers, and other manual tools may be used to remove coating that have deteriorated or are substantially crosslinked. Intentionally inducing cross-linking by overheating the powder coating during application or degrading by excessive heating after coating application results in easier removal. Conventional abrasive blasting at 60 PSI will remove these coatings. For areas requiring nondestructive inspections on bare metal, brush a release agent (NSN 9150-00-349-9290) on the specific NDI site after each inspection prior to coating or re-coating. When removal is required, carefully score the site and peel the coating off. Reapply the release agent after the inspection cleanup before re-coating. Small areas may also be reheated with a hot air

gun or small propane torch to soften the thermoplastic and then manually scrape the area requiring removal while the coating is still soft. For coatings that are still serviceable with a low degree of cross-linking, or if induced cross-linking is not feasible, MPW blasting per Paragraph 2.12 is an effective method for removal. MPW blasting augmented with sodium bicarbonate is more effective in removing the powder coatings.

## 2.14 PAINT REMOVAL ON NON-METALLICS.

2.14.1 Removal Requirements. Non-metallics are defined as Fabric Covered Surfaces, Fiber Glass, Arranged Fiber ("Kevlar")/Epoxy, and Graphite or Boron Fiber/Epoxy Composite Surfaces. Non-metallics are susceptible to severe damage by any of the paint removal processes, if improperly used. Therefore, these limited and specific procedures for removal of organic coatings shall be used only when the responsible Air Logistics Center (ALC), Aircraft System Program Director (SPD) or Equipment or Component Item Manager, with the full knowledge of the ALC Corrosion Program Manager, approves the procedure to be used.



- Chemical removers used for finish system removal from metal surfaces shall not be used on any non-metallics identified in this section, unless approved within weapon system specific technical orders.
- Sharp-edged and sharp-cornered tools shall not be used as scrapers for removal of the finish system from fabric covered surfaces, as they can easily puncture or tear the fabric. Scrapers shall not be pushed across the surface, but shall be held with the blade angled away from the body and pulled across the surface toward the body to prevent gouging of the fabric.

2.14.1.1 PMB per Paragraph 2.11.5 may be used for paint removal on Fiber Glass, Arranged Fiber ("Kevlar")/Epoxy, and Graphite or Boron Fiber/Epoxy Composite Surfaces; but if unavailable or unauthorized, use the mechanical methods in Paragraph 2.14.2 step a, step b, and step c below. If repairs require the total removal of the topcoat and primer, refer to TO 1-1-690 for additional procedures and precautions. Chemical removal of coatings from composite surfaces is not authorized. Refer to mechanical removal procedures for these components.

2.14.2 Mechanical Paint Removal on Fiber Glass, Arranged Fiber (“Kevlar”)/Epoxy, and Graphite or Boron Fiber/Epoxy Composite Surfaces.

**WARNING**

Do not mount an abrasive on a motor driven tool having an operational speed higher than the maximum RPM rating of the abrasive. This can result in disintegration of the abrasive and can cause injury to personnel.

**NOTE**

The following procedures are not applicable to radomes. Finish system removal from radomes shall be accomplished per instructions in TO 1-1-24.

- a. Abrade the finish system topcoat from the surface down to the primer with hand held abrasives per Table 2-1 and Table 2-3 or either a random orbital tool or pneumatic drill motor (12,000 RPM max) fitted with a roloc or hook and loop mounted surface conditioning disc or a cloth abrasive disc per Table 2-2 and Table 2-3. Use sanders attached to high efficiency vacuum systems for dust recovery. Use of a random orbital tool or a pneumatic drill motor fitted with the “Scotch-Brite” medium grade, aluminum oxide, surface conditioning disc (3M Co.) is preferable. This method provides the fastest removal rate with the least possibility of damage to the composite substrate and the longest abrasive life due to the non-loading characteristics of this type of disc. Keep sander heads flush against the surfaces being sanded and apply the least amount of pressure necessary to effectively remove the finish system topcoat and not go through the primer and gouge or abrade the composite substrate.
- b. Abrade the primer from the surface using the same methods as used for the topcoat but with finer grade abrasives per Table 2-1 and Table 2-3 using the same methods as specified for the topcoat in paragraph above. Extreme caution is to be used to avoid any damage to the composite materials. Re-coating of exposed composite materials should be accomplished at the earliest opportunity as composite materials degrade when exposed to ultra violet (UV) light.
- c. After all topcoat has been removed, use HEPA vacuums with appropriate attachments to vacuum dust from aircraft and facility floors. Do not use compressed air unless absolutely necessary to remove dust from very narrow cracks and crevices.

## CHAPTER 3

### SURFACE PREPARATION AND CHEMICAL PREPAINT

#### SURFACE TREATMENT

#### 3.1 SURFACE PREPARATION FOR PAINTING AND CHEMICAL PREPAINT SURFACE TREATMENT.

The life of an organic coating system, its effectiveness and the appearance of organic finishes depend more on the condition of surfaces receiving them than any other factor. Most surfaces can be expected to present adverse painting conditions due to either the inherent nature of the material, the environment in the presence of foreign materials, contamination, or corrosion. Presence of any of these factors will require treatment or removal action to make possible the proper application of organic coatings. The life and effectiveness of organic coatings are an integral part of corrosion prevention and control for aerospace equipment. These procedures are for preparation of interior or exterior surfaces that have existing coating systems to be re-coated or repaired. These procedures are also for surface preparation after complete depainting prior to the complete repainting of an aircraft. All Technical Order requirements and procedures for prepaint preparation of metal surfaces other than aluminum and magnesium, which may be used on aircraft exterior surfaces, shall be complied with in addition to requirements of this manual.

##### 3.1.1 Surface Preparation For Painting.

#### WARNING

- Refer to Table 3-1 for minimum personal protective equipment required for all paint preparation operations.
- Provide adequate ventilation when using solvents. Avoid prolonged breathing of vapors and avoid skin contact. Use appropriate protective gloves and eye protection. Contact Bioenvironmental Engineering to determine need for respiratory protection.

Surface preparation for painting is the most important requirement for insuring proper adherence and performance of a paint system. For the purposes this manual, there are two types of surfaces requiring preparation for painting; bare unpainted surfaces (metal or composite material) and surfaces with organic coatings currently applied. In either case, an exceptionally clean surface is necessary whether painting over an existing paint system, painting newly fabricated aircraft or components, or after complete removal of an existing paint system or to overcoat an existing paint system must be thoroughly prepared before the re-application of new organic coatings.

3.1.2 Surface Preparation For Repair or Over Coating of Damaged Organic Coating. Closely inspect candidate areas for the extent of damage and maintenance painting required. If inspection reveals major paint failure or damage, such as chipped or peeled paint from the center of a skin panel, the involved skin section should be prepared and maintenance painted from seam to seam. If only minor damage is found, i.e., paint chipped or missing from screw/ rivet heads and on outer edges of skin panel(s) the specific area may be prepared and maintenance painted. Prepare damaged area(s) as follows:

3.1.2.1 Thoroughly clean the area to be prepared per TO 1-1-691 or using solvent wipe procedures per Paragraph 3.1.4.

#### WARNING

- Sanding of finish systems using motor driven abrasives can generate airborne particles and toxic dust that can injure personnel and create a possible dust explosion from paint and abrasive material dust. Work pieces and motorized equipment shall be properly electrically grounded. When using motor driven abrasives the minimum required personnel protective equipment shall be dust/particulate respirator, goggles/face shield, disposable nitrile rubber gloves, and cloth coveralls with paint sock or hooded Tyvek coveralls and non-slip rubberized foot coverings. Do not stand above, below or directly next to other workers. Avoid being “downwind” from others using mechanical sanders. Consult Bioenvironmental Engineering Services for respiratory and ventilation requirements.
- Do not mount an abrasive on a motor driven tool having an operational speed higher than the maximum RPM rating of the abrasive. This can result in disintegration of the abrasive and can cause injury to personnel.

3.1.2.2 Feather the edges of damaged coating adjacent to the peeled section. Use 120 grit or finer abrasive paper or nylon abrasive matting material Specification A-A-58054 medium grade or finer for sanding. When using the coarser grit sizes down to 120 use care not to score the metal surfaces. Sanding to feather-out the damaged coatings may be done by hand or with the use of either a random orbital tool or pneumatic drill motor (12,000 RPM max) fitted with a roloc



or hook and loop mounted surface conditioning disc, or a disc fabricated from an abrasive cloth sheet. Use sanders and grinders attached to high efficiency vacuum systems for dust recovery. Keep sander heads approximately flush against the surfaces being sanded and apply the least amount of pressure necessary to accomplish feathering of the paint.

**NOTE**

It is essential that a formal maintenance/repair schedule be instituted for the high efficiency vacuum units. Replace bags in vacuum units after each aircraft or large part has been sanded. Do not use vacuums when the hoses have holes or tears. Use the minimum length of hose attached to vacuum units to ensure the highest airflow rates through the vacuum. Use the vacuum at the manufacture's recalls compressed air pressure.

3.1.2.3 Scuff-sand the surface of other area(s) adjacent to the damaged coatings that are to be coated using abrasive paper no coarser than 120 grit, 3M Corp medium grade aluminum oxide surface conditioning disc, or A-A-58054, Type I, Class 1, Grade C abrasive mat. Use of a random orbital sander or a pneumatic drill motor fitted with the surface conditioning disc is preferred.

3.1.2.4 After the finish system has been sanded, use HEPA vacuums with appropriate attachments to vacuum dust from aircraft and facility floors. Do not use compressed air unless absolutely necessary to remove dust from very narrow cracks and crevices.

3.1.3 Scuff Sanding For Overspraying Existing Coating Systems On Aircraft. It is always better to start a paint system from bare metal, however, when authorized in Chapter 8, it is feasible to overspray existing paint systems.

**NOTE**

Adhesion failure between coatings will require complete removal of the non-adhering coating. When intercoat adhesion failure occurs over large areas, overcoating shall not be accomplished and complete strip/repaint is required.

3.1.3.1 Aircraft exterior painted surfaces shall initially be cleaned in accordance with TO 1-1-691 and thoroughly inspected to determine the soundness the paint film. Areas of severely deteriorated paint as indicated by loose or peeling paint, contamination from hydraulic oil, engine oil, fuel or other fluids, or where bare metal is showing, shall be stripped per Chapter 2 of this manual.

3.1.3.2 Mask all areas which may be damaged by entry of fluids or paint dust generated during the cleaning and scuff sanding operations per Chapter 2 of this manual.

3.1.3.3 Prepare the surface for overcoating by scuff sanding as follows:

**WARNING**

- Sanding of finish systems using motor-driven abrasives can generate airborne particles and toxic dust that can injure personnel and create a possible dust explosion from paint and abrasive material dust. Work pieces and motorized equipment shall be properly electrically grounded. When using motor driven abrasives the minimum required personnel protective equipment shall be dust/particulate respirator, goggles/face shield, disposable nitrile rubber gloves, and cloth coveralls with paint sock or hooded Tyvek coveralls and non-slip rubberized foot coverings. Do not stand above, below or directly next to other workers. Avoid being "downwind" from others using mechanical sanders. Consult Bioenvironmental Engineering Services for respiratory and ventilation requirements.
- Do not mount an abrasive on a motor driven tool having an operational speed higher than the maximum RPM rating of the abrasive. This can result in disintegration of the abrasive and can cause injury to personnel

**NOTE**

Requirements for vacuuming of sanding dusts may be waived by local Bioenvironmental Engineering, Industrial Hygienists, or the OPR for corporate safety/health only after approval of alternative measures for personnel protection.

3.1.3.3.1 Completely scuff-sand the entire exterior surface of the aircraft, excluding bare metal areas, using abrasive paper no coarser than 120 grit, 3M Corp medium grade aluminum oxide surface conditioning disc, or A-A-58054, Type I, Class 1, Grade C abrasive mat. Scuff sanding shall include roughing up 100% of the painted surface, removal of oxidized paint, and feather-edging of all flaked paint. It is not intended to remove a sound paint system. Light scuffing is sufficient for adhesion of the primer tie-coat to a sound topcoat. Do not sand through to bare metal as damage to the aircraft may occur. All areas where the paint system is nicked, scratched, or chipped and any edges of the paint system around areas where paint removal was done are to be feathered-out (blended smooth) during the sanding operation per Paragraph 3.1.2. All sanding operations should be accomplished using either a random orbital tool or pneumatic drill motor (12,000 RPM max) fitted with a roloc or hook and loop mounted surface conditioning disc, or a disc fabricated from an abrasive cloth sheet. Use sanders and grinders attached to high efficiency vacuum systems for dust recovery. Keep sander heads approximately flush against the surfaces being sanded and apply the least amount of pressure necessary to accomplish feathering of the paint.

**NOTE**

It is essential that a formal maintenance/repair schedule be instituted for the high efficiency vacuum units. Replace bags in vacuum units after each aircraft or large part has been sanded. Do not use vacuums when the hoses have holes or tears. Use the minimum length of hose attached to vacuum units to ensure the highest airflow rates through the vacuum. Use the vacuum at the manufacture's recommended compressed air pressure.

3.1.3.3.2 After the finish system has been sanded, use HEPA vacuums with appropriate attachments to vacuum dust from aircraft and facility floors. Do not use compressed air unless absolutely necessary to remove dust from very narrow cracks and crevices.

3.1.3.3.3 Complete all remaining operations for preparation of the aircraft for painting as required in Chapter 4 of this manual.

3.1.4 Solvent Wiping For Surface Preparation. Solvent wiping may be used for general cleaning prior to surface preparation or for final cleaning prior to coating application. A clean surface is one of the most critical process requirements that must be met to ensure coating adhesion. Depending on the process requirement, solvent selection should be made from the approved solvents in Table 3-2. The necessity

for having an exceptionally clean surface to receive the new paint system requires that a solvent wipe be done: 1) if the surface becomes contaminated after chemical treatment, 2) after all scuff sanding operations, and 3) if required for reactivation of coating. Given these requirements, a hand solvent wipe shall be performed each time the coating sequence of an aircraft is broken and the surface has been vulnerable to the accumulation of soils such as dust, shop dirt, fingerprints, overspray, leaks, etc., either after conversion coating application, priming, or between topcoats. This will be accomplished immediately prior to application of further paint coats to assure cleanliness and the adhesion of the paint film to the surface. The hand solvent wipe-down shall be accomplished using materials per Table 3-2. The solvent will be applied and the surface wiped using wiping cloths. Wiping cloth (CID A-A-59323) shall be lint free, 100 percent cotton cloth conforming to A-A-2522, Grade A, color 1: cotton gauze/cheese cloth conforming to CCC-C-440, Type II or III, which are unbleached or white cleaning cloths conforming to AMS 3819A, Class 2, Grade A, and have not been exposed to any other chemical solution. When accomplishing the solvent wipe, always pour fresh solvent onto the cloth and dispose of them as they accumulate soils. The solvent wipe must be performed in this manner in order to prevent simply smearing soils or transferring them back to the surface from a pail of contaminated solvent. This operation must be accomplished when required and always just prior to application of the primer or subsequent paint topcoats.



Table 3-1. Minimum Recommended Controls and PPE for Surface Preparation Operations<sup>a</sup>

Operation	Engineering Controls	Personal Protective Equipment						
		Respiratory	Hand	Ear	Eye	Body	Foot	
Masking	None	None	None	None <sup>b</sup>	None	None	Safety toe boots	
Corrosion removal (acid etch)	General dilution ventilation	Air-purifying with HEPA filter	Butyl rubber gloves	Ear plugs <sup>c</sup>	Safety goggles or faceshield <sup>d</sup>	Rain suit	Safety toe boots	
Conversion coating (alodine)	General dilution ventilation	Air-purifying with HEPA filter	Butyl rubber gloves	Ear plugs <sup>c</sup>	Safety goggles or faceshield <sup>d</sup>	Rain suit	Safety toe boots	
Alodine Sempen	General dilution ventilation	None	Disposable nitrile gloves	None <sup>b</sup>	None	None	Safety toe boots	
Alodine "wipe-on/blot-off"	General dilution ventilation	None	Disposable nitrile gloves	None <sup>b</sup>	Safety goggles or faceshield	Tyvek or cotton coveralls	Safety toe boots	
Sanding	HEPA-ventilated sander	Air-purifying with OV/HEPA cartridges <sup>e</sup>	Disposable nitrile gloves	Ear plugs	Safety goggles <sup>d</sup>	Tyvek or cotton coveralls	Safety toe boots	
Dust removal	HEPA vacuum	None	Disposable nitrile gloves	Ear plugs <sup>c</sup>	None	Tyvek or cotton coveralls	Safety toe boots	
Solvent wiping	General dilution ventilation	Air-purifying with OV cartridges <sup>f</sup>	Disposable nitrile gloves	None <sup>b</sup>	Safety goggles or faceshield <sup>d</sup>	Tyvek or cotton coveralls	Safety toe boots	

<sup>a</sup> Local Bioenvironmental Engineer may recommend more restrictive controls or PPE based on exposure monitoring

<sup>b</sup> Hearing protection may be required in locations where hazardous noise is produced from other sources

<sup>c</sup> When noise levels exceed 85dBA

<sup>d</sup> Not required if a full-facepiece or hooded respirator is worn

<sup>e</sup> A powered air-purifying respirator (PAPR) with hood is the best choice for scuff sanding

<sup>f</sup> When chemical exposure levels exceed occupational exposure limits

**CAUTION**

These solvents should not be used on polycarbonates or acrylics. These solvents will cause most rubber products to swell; however, the rubber will return to its original shape when the solvent evaporates.

**NOTE**

Low vapor pressure NESHAP compliant solvents are slow to evaporate and must be wiped dry before paint application. These are the preferred solvents.

3.1.4.1 Solvent-Wipe, Aircraft Prepaint for Environmental Compliance. Environmental requirements have placed restrictions on use of some solvents. When using any solvents that are being restricted by environmental regulations, minimize consumption by using only a small amount of solvent on a wiping cloth; do not saturate the cloth. Wipe the surface being cleaned and then wipe with a dry wiping cloth. When the cloth becomes soiled, dispose of it in a closed container. This operation must be accomplished when the surface to be painted has become contaminated and always just prior to application of primers or subsequent topcoats. Always check with the local base Environmental authorities for restrictions and full compliance requirements. Table 3-2 lists approved alternative solvents that will meet many environmental regulatory requirements.

3.1.5 Surface Preparation For MIL-C-27725/SAE AMS-C-27725 Integral Fuel Cell Coating.

**WARNING**

- A-A-59281 is flammable and toxic to eyes, skin, and respiratory tract. Eye and skin protection required. Good general ventilation is normally adequate.
- MIL-C-81706/MIL-DTL-81706 is toxic to eyes, skin, and respiratory tract. Eye and skin protection required. Consult Bioenvironmental Engineering Services to determine need for respiratory and ventilation requirements.

The integrity of fuel tank coatings is critical to all aircraft, and surface preparation requirements are specific and not to be wavered from. Clean surfaces to be coated with MIL-C-27725/SAE AMS-C-27725 using only A-A-59281, Type I Cleaning compound. A-A-59281, Type I is a solvent blend designed for this application. Apply A-A-59281, Type I to a lint-free cleaning cloth. Wipe Dry. Do not allow the solvent to evaporate. Change cleaning cloths regularly as required to ensure soils are not spread or transferred. Immediately follow the solvent wipe with application of conversion coating conforming to Specification MIL-C-81706/MIL-DTL-81706 per Paragraph 3.1.19.

**Table 3-2. Wipe Solvents**

Solvent Selection	Metals	Organic Coatings FL 6	Coated Solvent Resistant Finishes FL 6	Composite Materials	Reactivation of Painted Surface	Regulated By NESHAP FL 1	Meets Requirements of NESHAP FL 2	NESHAP Exempt FL 3
	Surface to be Cleaned					Compliance		
<b>Alcohols</b>								
Ethyl alcohol, denatured FL 4	G	G	G	G				X
Isopropyl alcohol FL 4	GF	GF	G	G				X
<b>Napthas/Petroleum Distillates</b>								
P-D-680, Type II, III, Dry Cleaning Sol.	G	G	G				X FL 5	
TT-N-95, Aliphatic Naptha	G	G	G	G			X FL 5	

Table 3-2. Wipe Solvents - Continued

Solvent Selection	Metals	Organic Coatings FL 6	Coated Solvent Resistant Finishes FL 6	Composite Materials	Reactivation of Painted Surface	Regulated By NESHAP FL 1	Compliance	
							Meets Requirements of NESHAP FL 2	NESHAP Exempt FL 3
		Surface to be Cleaned						
A-A-2904, Mineral Spirits	G	G	G				X FL 5	
<b>Ketones</b>								
Acetone	GF		GF	GF	X			X
Methyl Ethyl Ketone (MEK)	F	F	F	F	X	X		
Methyl Propyl Ketone (MPK)	GF		GF	GF	X		X #	
<b>Specialty Solvents</b>								
Parachlorobenzotrifluoride (PCBTF)	G		G	G	X			X
<b>Solvent Blends</b>								
MIL-T-81772, Type II	GF					X		
1:1 MEK Toluene	F	F	F	F	X	X		
1:1 MEK Acetone	GF		GF	GF	X		X #	
1:1 MPK Naptha	G	G	G	G			X #	
1:1 Acetone: PCBTF	GF		GF	GF	X			X
A-A-59231	F					X		
DS-104, Dynamold Solvents, Inc	GF	GF	GF	GF			X *	
DS-108, Dynamold Solvents, Inc	GF	GF	GF	GF			X *	
SD 1291, Brulin Corp.	G		G	G			X *	
Super 140, LPS Industries	G		G	G			X *	
<b>Terpenes</b>								
Citra Safe, Inland Technology	GF		GF	GF			X *	
De-Solv-It , Orange-Sol, Inc.	G		G	G			X *	

G = Use for General Cleaning in surface preparation for painting (General cleaners not approved for Final Cleaning leave a residue and must be followed by Final Cleaning before painting.)

F = Use for Final Cleaning before paint.

FL 1 = If the requirements of the National Emission Standards for Hazardous Air Pollutants (NESHAP) must be complied with, these solvents maybe restricted from use or have very specific limitations applied to their use.

FL 2 = These solvents meet the requirements of the NESHAP for compliance. This only applies where the requirements of the NESHAP are being enforced.

# = These solvents have a vapor pressure not exceeding 45 mm Hg (24.1 in H<sub>2</sub>O) at 20° C (68° F) and will have reporting and other requirements under the NESHAP.

\* = These solvents are composed of a mixture of photochemically reactive hydrocarbons and oxygenated hydrocarbons and have a maximum vapor pressure of 7 mm Hg at 20° C (3.75 in H<sub>2</sub>O at 68° F). There are no reporting requirements or containment controls on the use of these solvents. NOTE: These solvents evaporate slowly and must be completely dried prior to application of paint.

FL 3 = These solvents are exempt from any reporting and controls under the NESHAP. Not all local state authorities have granted these exemptions.

FL 4 = Alcohol's are not compatible with polyurethane's. Make sure they are totally removed before applying polyurethane's.

FL 5 = Most vendor's products which meet specifications are NESHAP compliant, but some are not. Check vendor's MSDS to determine if composite vapor pressure is 45 mm Hg or less and therefore compliant.

FL 6 = See Glossary for definitions of "Organic Coatings" and "Solvent Resistant Coatings".

### 3.1.6 Reactivation of Newly Applied Primer or Tiecoat.

All standard organic coating systems consist of an approved primer and topcoat or tiecoat and topcoat. In the application process, many times it is critical that topcoats be applied to the primer before the primer completely cures. Specific coating cure times are listed in Chapter 6. When the cure time is exceeded, the primer or tiecoat must be reactivated to assure adhesion of the topcoat. Reactivation may be accomplished either through a solvent wipe or by scuff sanding. Solvent wipe for reactivation is normally allowed within a specified window during the curing process and is not effective for fully cured coatings. When solvent wipe is permitted, wipe the entire aircraft surface with a white lint-free, cotton cloth (CID A-A-59323) conforming to A-A-2522, Grade A, color 1 (PN AA 522-A1) or cotton gauze/cheese cloth conforming to CCC-C-440, Type II or III wetted with one of the solvents approved for this process in Table 3-2. Ensure surfaces are completely wetted to soften the coating and promote reaction between the solvents and binders in the topcoat with the primer or tiecoat for adhesion. Scuff sanding for reactivation shall be accomplished using 320 or 400 grit sandpaper, A-A-58054, Type I, Class 1, Grade B abrasive mat, or hook and loop or roloc mounted surface condition discs "very fine" grade (3M Co.) to reactivate the primer or tiecoat for adhesion of the topcoat. Surfaces shall be scuff sanded 100% using procedures in Paragraph 3.1.3 followed by a solvent wipe per Paragraph 3.1.4.

**3.1.7 Surface Preparation, Unpainted Surfaces.** The final step in surface preparation for coatings application is the inspection and treatment of unpainted metal surfaces, i.e.; areas of peeled or damaged coatings; depainted surfaces; or new repairs or fabricated components. A thorough inspection for corrosion shall be conducted over the entire surface to be painted. All areas requiring mechanical and chemical corrosion removal will be identified and marked.

**3.1.8 Corrosion Removal, Chemical and Mechanical.** All chemical and mechanical corrosion removal required for treatment of corrosion damage shall be accomplished in accordance with the System Specific Corrosion Control technical Order and TO 1-1-691. All corrosion removal and treatment shall be accomplished prior to performing prepaint processes in this manual.

### NOTE

All work requirements, repairs, mechanical corrosion removal, and sealing requirements (sealant cured completely) shall be completed, inspected and have all defects corrected prior to prepaint cleaning and surface preparation. Failure to comply with the above requirement will cause paint adhesion problems and severe delays in painting operations.

**3.1.9 Preparation for Prepaint Treatment, Unpainted Surfaces.** Prior to application of corrosion removal compounds on aluminum or magnesium, all surfaces to be treated shall be thoroughly cleaned of dirt, grease, and contamination. Immediately prior to prepaint treatment evaluate surfaces and clean as follows:

**3.1.9.1** Conduct a thorough inspection over the complete surface to be treated to ensure all foreign matter that may have been retained in seams, or oily deposits that may have accumulated during or after cleaning, have been removed. Also, all corrosion that is to be chemically treated during the prepaint surface preparation must be identified.

**3.1.9.2** All surfaces shall be regarded as dirty even if there is no visible dirt. Carefully wash the aircraft or surfaces to be treated per TO 1-1-691 and spot clean using solvent wipe per Paragraph 3.1.4.

**3.1.9.3** Water break tests shall be conducted on representative areas to be treated immediately prior to application of corrosion removal prepaint solutions.

**3.1.10 Water Break Inspection.** The following procedures shall be used to comply with the water break inspection. A Water Break Free Kit (NSN 6850-01-524-8291) is available, which contains all the items needed to complete the test. A mist of distilled or clean tap water is atomized on the surface to be coated employing any convenient small atomizing spray device. If the water gathers into discrete (separate) droplets within 25 seconds, that is, if the surface shows a water break within this time, the surface shall be considered as failing the test. If the water forms a continuous film by

flashing out suddenly over a large area, it shall be considered as evidence of impurities on the surface such as free alkali, residual detergents, etc., and the surface shall also be considered as failing the cleanliness test. If the water drops coalesce (go together) into a continuous film of water without a sudden flash out and form a lens, then the surface shall be considered as having satisfactorily passed the water break test. Any areas that fail the test shall be cleaned per TO 1-1-691, and reinspected.

**3.1.11 Evidence of Inadequate Cleaning.** During pre-paint operations of acid-etch and chromate conversion coatings, surfaces should also be monitored for evidence of undetected soiled areas. When accomplishing the rinse of etch or conversion coating solution and a rapid flash off or breaking of the rinse water occurs, this indicates an unsatisfactorily cleaned area not detected during the random sample of the water break test. Areas that show evidence of inadequate cleaning during rinsing require recleaning and accomplishment of pre-paint surface preparation.

### 3.1.12 Corrosion Removal Prepaint Compound, Aluminum.



- Exposure of magnesium surfaces to aluminum prepaint chemicals will initiate corrosion which will continue even under a new paint system and ultimately cause severe damage.
- All magnesium surfaces, steel/high strength steel and cadmium plated surfaces shall be protected from MIL-C-38334/SAE AMS-1640 solutions.

Masking of all lap joints, hinges, faying surfaces, access doors, air scoops and other openings that would allow MIL-C-38334/SAE AMS-1640 to enter or be entrapped is required prior to beginning the require prepaint process. Also, masking of unprotected magnesium, steel and cadmium-plated components shall be done at this time. Masking will be accomplished per Chapter 2, using masking procedures for chemical paint removal.

**3.1.13 Prepaint Chemical Corrosion Removal Materials.** Corrosion removal compound, prepaint specification MIL-C-38334/SAE AMS-1640, is used for removing oxidation and corrosion products from aluminum alloys which are not required to be Liquid Oxygen (LOX) compatible. MIL-C-38334/SAE AMS-1640 is available in two types.

**3.1.13.1** Type I, liquid concentrate, which is diluted with an equal amount of water before use.

**3.1.13.2** Type II, powdered concentrate kit, materials will be dissolved in the volume of water specified on the kit.

### 3.1.14 Application of MIL-C-38334/SAE AMS-1640 Solution/Not LOX Compatible.

#### **WARNING**

MIL-C-38334/SAE AMS-1640 is moderately toxic to the skin, eyes and respiratory tract. Eye and skin protection is required. Good general ventilation is normally adequate.

Apply solution by flowing, mopping, sponging, brushing or wiping. The solution is more effective if applied warm (130° F ±10° F), followed by vigorous agitation with a non-metallic, acid-resistant brush or aluminum-oxide-abrasive, nylon mat (A-A-58054, Type I, Grade A). When applying the solution to large areas, start at the lowest surface working upward. Applying the solution with a circular motion to disturb the surface film will assure proper coverage. Allow the solution to remain on the surface approximately 12 minutes, then rinse away with potable water. Corroded areas identified for treatment during the prepaint process may require additional agitation beyond that specified above. Corroded areas being treated during the prepaint may also require more than one application and rinse. Examine the areas being treated with a 4 to 10 power magnifying glass to determine if another application is required. MIL-C-5541/SAE AMS-C-5541/MIL-PRF-81706/MIL-C-81706 chromate conversion coating shall be applied immediately after the final rinse, and before the surface dries.

#### **NOTE**

When a large area/aircraft is being treated with MIL-C-38334/SAE AMS-1640 start applying solution to lowest point first and work upward.

### 3.1.15 Surface Treatment Materials For Aluminum.

There are two specifications which cover formation of Chromate Conversion Coatings with its attendant process application and the Chemical Conversion Materials. These two specifications and their scope are as follows:

#### **NOTE**

Chromate Conversion coating specification MIL-C-5541/SAE AMS-C-5541 should be applied after the manufacture of new aluminum alloy repair parts.

**3.1.15.1** Chromate Conversion coating specification MIL-C-5541/SAE AMS-C-5541 covers two classes of chemical conversion coatings formed by the reaction of chemical conversion materials and the surfaces of aluminum and aluminum alloys. It is designed to provide corrosion protection and better paint adhesion than uncoated aluminum. It is used on aluminum alloys as a prepaint treatment for most



approved paint systems; repair of damaged anodic coatings; and treatment of corrosion rework areas on clad and unclad aluminum alloys. This specification covers the preparation and application of chemical conversion materials, and film formation or consistency. These coatings are not as abrasion-resistant as anodized coatings conforming to specification MIL-A-8625, even though they do provide an effective means for re-establishing the corrosion resistance of mechanically damaged anodic coatings in the field. Specification MIL-C-5541/SAE AMS-C-5541 covers two classes of films as follows:

3.1.15.1.1 Class 1A - For maximum protection against corrosion.

3.1.15.1.2 Class 3 - For protection against corrosion where low electrical resistance is required.

3.1.15.2 Specification MIL-C-81706/MIL-DTL-81706, Chemical Conversion Materials for Coating Aluminum and Aluminum Alloys, covers the chemicals used in the formation of conversion coatings. These are available under this specification in three forms:

- Form I - Concentrated Liquid
- Form II - Powder
- Form III - Premixed liquid (ready for use touch-up brush application)

3.1.15.3 Each form of MIL-C-81706/MIL-DTL-81706 can be applied by spray, brush or immersion. Materials for Class 1A chemical films are available in iridescent yellow or light brown, or dyed in specific colors. The repaint treatment of aircraft surfaces prior to repainting will be accomplished using specification MIL-C-5541/SAE AMS-C-5541, Class 1A coatings, using specification MIL-C-81706/MIL-DTL-81706, color iridescent yellow.

3.1.16 Touch-Up of Damaged Aluminum Surface Treatment MIL-C-5541/SAE AMS-C-5541. The touch-up of damaged MIL-C-5541/SAE AMS-C-5541 coatings due to maintenance or surface preparation for maintenance painting can be accomplished using one of three methods:

3.1.16.1 MIL-C-81706/MIL-DTL-81706, mixed (if required) per Paragraph 3.1.18 and applying to affected areas per Paragraph 3.1.19.

3.1.16.2 MIL-C-81706/MIL-DTL-81706, mixed (if required) per Paragraph 3.1.18 and applying to affected areas per the "NO-RINSE PROCESS" in Paragraph 3.1.17.

3.1.16.3 Touch-N-Prep™ (TNP) Pens (Alodine 1132). NSN 8030-01-460-0246, for minor repair of damaged MIL-C-5541/SAE AMS-C-5541 chemical conversion coatings on aluminum alloys can also be accomplished by applying Alodine 1132 using the TNP pens. These pens also conform to MIL-C-81706/MIL-DTL-81706, Class 1A, Form VI,

Method D. The solution applied with TNP pens doesn't require rinsing or wiping off following application, thus minimizing hazardous waste generation. Empty pens can be returned to manufacturer for disposal. However, check with Bioenvironmental Engineering and Environmental Management for proper disposal of used applicators. To use the TNP pen, remove the cap and charge the tip by pressing the tip against a flat surface for 10 to 15 seconds. The conversion coating solution will saturate the tip. Do not oversaturate the tip. Refresh solution often during use in a similar fashion.

#### NOTE

Acrylic tip of TNP pen can be modified or altered to form any shape to allow touching up hard to reach areas.

- a. It is necessary to ensure the surface to be treated is thoroughly cleaned before application. Immediately following cleaning, use the TNP pen to apply a chemical conversion coating solution in overlapping parallel strokes. Do not over apply the solution which would allow puddles, drips, or runs to form.
- b. Apply one coat of solution and allow coating to dry for 5-10 minutes before next application.
- c. Apply a second coat perpendicular to the first coat and allow it to dry. The treated surface does not require rinsing or wiping off, and it can be air dried at ambient temperature or force air dried with hot air. Once completely dried, the coating is ready for priming and/or painting.
- d. Use of TNP pen will be limited to 1 square foot.

3.1.16.4 After processing, if bare surface areas still exist repeat steps a through c. Also, if the treated surface does not turn to an iridescent yellow color shortly following application, re-clean the surface and reapply per steps a through c.

3.1.17 "No-Rinse Process" For Surface Treatment of Aluminum. This process is for applying conversion coating using a "wipe-on and blot-off" method. This procedure can be used in order to minimize hazardous waste water generated from the application of MIL-C-81706/MIL-DTL-81706 solutions. This process is for use on repaired areas and where coatings have been damaged or removed. Application of this process is not to exceed 4 sq. ft. per occurrence.

- a. Apply corrosion removal solution (MIL-C-38334/SAE AMS-1640, diluted with an equal amount of water) by sponging, brushing, or wiping. The solution is more effective if applied warm (130° F ± 10° F), followed by vigorous agitation with a non-metallic, acid-resistant brush or aluminum-oxide-abrasive, nylon mat (A-A-58054, Type I, Grade A), or scouring pads. Applying the solution with a circular motion will disturb the surface film and assure proper coverage. Allow the solution to remain on the surface approximately 12 minutes. Keep the surface wet during the entire 12 minutes. Rinse, using a clean cloth dampened with cold potable water.



After rinsing with cold water, allow the water to evaporate until a thin film of water exists on the surface. Corroded areas identified for treatment during the pre-paint may require more than one application and rinse. Examine suspect areas being treated with a 4 to 10 power magnifying glass to determine if another application is required.

- b. All requirements of Paragraph 3.1.18 through Paragraph 3.1.18 step b shall be complied with prior to the "wipe-on and blot-off" method.
- c. MIL-C-5541/SAE AMS-C-5541/MIL-C-81706/MIL-DTL-81706 chromate conversion coating shall be applied immediately after the evaporation period. After allowing the aluminum part to dry to a damp surface, dampen a white cotton wiping rag with MIL-C-81706/MIL-DTL-81706, Class 1A, Form III, corrosion conversion coating. Dampen the rag by slowly pouring the liquid onto the rag (this will keep the material uncontaminated and minimize the amount of material being used. The rag will have a yellowish color.
- d. Wipe-on the conversion coating to the still wet aluminum part. Apply the coating in a manner such that streaking is minimized and a thin uniform coat is developed. On areas where difficulty is experienced in getting the conversion coating to react with the aluminum, light abrading with a very fine or fine aluminum oxide nylon abrasive mat, specification A-A-58054, dampened with MIL-C-81706/MIL-DTL-81706 will help overcome the difficulty. If dark brown spots or streaking occurs, lightly rub the area with fingers of your glove.
- e. Allow the conversion coating to react with the aluminum until the aluminum turns a brassy iridescent yellowish tint. The reaction time should be at least 3 minutes, but not longer than 5 minutes.

- f. Dampen a white rag in clean water and hand ring out the rag so it is not dripping with water. Blot all of the areas that have been conversion coated with the clean wet rag. The rag should become contaminated with the conversion coating, giving the rag a yellowish color. Repeat this procedure (starting with a clean rag) at least two more times so the surface has been blotted off at least three times. No visible coating residue (yellowish color) should be on the rag after the last blotting action.
- g. Areas not properly coated (including those that are powdery shall be recoated by reapplying fresh coating solution allowing it to react with aluminum until the aluminum turns a brassy iridescent yellowish tint.
- h. Contaminated rags, abrasive mats, and other materials shall be disposed of by placing them in an appropriate hazardous waste container.
- i. The coating should be allowed to air dry for 2 hours minimum or, if required, force dried by blowing dry with warm, clean air (140° F maximum) for 1 hour prior to overcoating with primer coating.

**NOTE**

Check with Bioenvironmental Engineering and Environmental Management for proper disposal of excess solution.

- j. The final protective primer or primer/topcoat system shall be applied only on a completely dry surface and within 48 hours after completion of the MIL-C-81706/MIL-DTL-81706 conversion coating application. The reapplication of MIL-C-38334/SAE-AMS-1640 corrosion removal compound and MIL-C-81706/MIL-DTL-81706 chromate conversion coating is mandatory if more than 48 hours has elapsed since the previous application.

3.1.18 Mixing MIL-C-81706/MIL-DTL-81706 Solution. The use of MIL-C-81706/MIL-DTL-81706 requires that the following precautions be observed.

**WARNING**

- MIL-C-81706/MIL-DTL-81706 conversion coating materials are toxic and require the use of rubber gloves and eye protection (goggles and face shield) by personnel mixing or applying. If the material (which is an acid) accidentally contacts the skin or eyes, flush immediately with plenty of clean water. Report to dispensary and/or consult a physician if eyes are effected or skin is burned.
- Mixing and application shall be done in an adequately ventilated area. Avoid prolonged breathing of vapors.
- Do not permit specification MIL-C-81706/MIL-DTL-81706 materials to come into contact with paint thinner, acetone, or other combustible material; fire may result. Also, any absorbent materials, i.e., rags, sponges, paper or nylon matting, etc., used in or exposed to these materials shall be rinsed in water before discarding. They are an extreme fire hazard if allowed to dry otherwise.

**CAUTION**

- Do not use MIL-C-5541/SAE-AMS-C-5541 or MIL-C-81706/MIL-DTL-81706 treatment on magnesium alloy, high strength steel, or on cadmium or zinc plated surfaces. If these materials are present in adjacent areas, they must be protected.
- Conversion coating material should not be allowed to enter faying surface areas or other areas where the solution can not be adequately removed by rinsing.

**NOTE**

- The solution will usually turn green during application if dirt or corrosion is present on the surface. The color green will not have the iridescent quality that a properly applied and dried solution will display.
- Select an area for mixing so spillage or splatter from solution will not cause damage to other equipment. Use only a stainless steel, plastic or rubber container to mix solution in. Mix only enough solution to coincide with the immediate job requirements in order that fresh materials will be available for each use.

- a. If specification MIL-C-81706/MIL-DTL-81706, Form II - Powder, is being used and it is not finely divided, crush by rolling on a clean piece of paper. This will improve mixing efficiency.

**WARNING**

Nitric acid is highly toxic to skin, eyes, and respiratory tract. Eye and skin protection is required. Use only in a well-ventilated area. In case of eye or skin contact, flush immediately with water and report to dispensary.

- b. Preparation and use of MIL-C-81706/MIL-DTL-81706, Form II - Powder, will be done in accordance with vendors technical instructions. This solution should be analyzed prior to use for pH value and hexavalent chromium content by the base chemical laboratory at depot facilities. Solutions used in field operations can be analyzed using pH paper or a pH meter and visual performance characteristics. Solution matter should be retested every five days and the chemical laboratory should be consulted should difficulties arise. Field operations prepare solutions as per vendors instructions and test per example below. Mix three ounces of MIL-C-81706/MIL-DTL-81706 powder to one gallon of clean water in an approved container. Add nitric acid, Federal Specification O-N-350 and check pH for range of 1.6 - 1.9. Five ml will usually adjust pH to this range however, it could require up to 15 ml. Mix solution well with a clean plastic or aluminum paddle. Check the time it takes to form an iridescent yellow to brown color on a sample of the same alloy the solution will be used on. If the time is more than 5 minutes, retest the pH and make the following adjustments:
  - (1) A pH greater than 1.9 will require addition of 2 ml portions of nitric acid until desired pH is achieved.
  - (2) A pH less than 1.6 will require addition of 2 ml portions of ammonium hydroxide until the desired pH is achieved. After pH adjustment the solution reaction time should fall within the range of 1 to 5 minutes.
- c. If powder material is being used, allow the solution to stand approximately 1 hour prior to application. A small amount of powder may not dissolve; however, this is not objectionable.

3.1.19 Application of MIL-C-81706/MIL-DTL-81706 Solutions.

- a. Apply the coating solution with a fiber brush, clean rag, sponge, applicator bottle (plastic), or low pressure stream (flow-on, do not atomize). The method used for application should be selected depending on the specific job requirement. If pumping is required, pumps, valves, and fittings shall be manufactured from 18-8 stainless steel, polypropylene or polyvinyl chloride (PVC). Flow

- on MIL-C-81706/MIL-DTL-81706 solution immediately after rinsing the MIL-C-38334/SAE AMS-1640 compound from aircraft surfaces which are to be painted and while these surfaces are still wet. Allow the gross amount of rinse water to run off the aircraft, but do not wait for completed drying before applying MIL-C-81706/MIL-DTL-81706 solution. The oxide film just removed by MIL-C-38334/SAE AMS-1640 compound will reform during this time period and prevent a proper formation of the MIL-C-5541/SAE-AMS-C-5541 conversion coating from the MIL-C-81706/MIL-DTL-81706 solution.
- b. Wet or flood the surface to be treated and keep the surface completely wet with the solution until coating is formed. This will take from 1 to 5 minutes depending on the surface condition, the particular manufacturer's product being used, and the temperature. Begin application at the lowest surface then apply sideways and upward to prevent streaking.
  - c. On areas where difficulty is experienced in getting the coating to take (coating formation), light abrading with a very fine or fine aluminum oxide nylon abrasive mat, specification A-A-58054, Type I, Grade B, soaked with the solution will help overcome the difficulty. If the surface is dirty, remove the dirt with the nylon mat or sponge. The mat or sponge used to remove the dirt should be rinsed in clean water and squeezed almost dry before wetting with stock coating solution for reapplication.
  - d. It will be noted during the initial coating application that there will be a tendency for dark (brown) spots to form on some areas. The formation of these spots can be prevented to some extent by lightly rubbing with the fingers (gloves on). If the spots are allowed to form, the applicable areas shall be abraded with the nylon mat to remove the stain, and a fresh coating shall be reapplied.
  - e. After controlling the stain formation, discontinue agitation, apply additional solution to keep all surfaces wet and observe the aluminum surface for a color change. The aluminum will turn a brassy, yellow or iridescent greenish tint, which is easily detected through the overlying solution.
  - f. Do not let the coating over-develop, or surface powdering will be experienced. Disturb such areas by rubbing with fingers (gloves on) or nonabrasive nylon mat as necessary.
  - g. When coating formation shows on all areas, stop the reaction by rinsing or flooding the area with fresh clean water. The reaction of the solution is stopped by diluting the acid component. Be careful not to flush the solution into areas where it cannot be removed or further diluted by water. Accidental spills in confined areas can be neutralized using baking soda followed by rinsing with clean water.
  - h. Allow the surface to drain or pick-up the excess water by absorbing in a sponge by blotting action; do not rub. Excess rubbing will remove the coating since it is soft.
  - i. Areas not properly coated (including those that are powdery) shall be recoated by reapplying fresh coating solution, abrading lightly with a nylon mat (nonabrasive or fine abrasive), allowing normal time for coating to develop, rinsing, and drying.
  - j. The coating should be allowed to air dry for 2 hours minimum or, if required, speed dried by blowing dry with warm clean air (140° F maximum) for 1 hour prior to using a part or painting.

#### NOTE

- Check with Bioenvironmental Engineer and Environmental management for proper disposal of excessive solution.
- The final protective paint system or primer shall be applied only on a completely dry surface and shall be applied within 48 hours after application of MIL-C-5541/SAE AMS-C-5541/MIL-C-81706/MIL-DTL-81706 conversion coating. The reapplication of MIL-C-38334/SAE AMS-1640 corrosion removal compound and MIL-C-81706/MIL-DTL-81706 chromate conversion coating is mandatory if more than 48 hrs has elapsed since the previous application.

### 3.1.20 Alternate Surface Preparations For Aluminum Surfaces (PreKote SP).



PreKote SP is for exterior mold line applications only.

#### NOTE

- PreKote SP requires specific System Program Office (SPO) approval prior to use.
- PreKote SP will only be used with chromated primers.
- PreKote SP is not a direct drop-in replacement for current chromated conversion coating processes. Unlike the application process for MIL-C-5541/SAE AMS-C-5541/MIL-C-81706/MIL-DTL-81706, which produces a visible indication that the chromate conversion film has formed, PreKote SP does not provide any type of visible indicators. Therefore, it is absolutely critical that all steps of the PreKote SP application process be precisely followed.

PreKote SP is a non-chromic, non-hazardous and non-toxic alternative to chromate conversion coatings for surface painting preparation operations. The PreKote SP formulation is a non-chromic alkali soap with a saline adhesion promoter and inorganic inhibitor package. The PreKote SP application cleans the surface and deposits a very thin layer of adhesion-promoting organic molecules on the surface of the substrate.

**3.1.20.1 Surface Preparation.** Preparation for aircraft cleaning shall be accomplished in accordance with TO 1-1-691 and any weapon system specific cleaning instructions. Rinse exterior of aircraft with hot water (100-120° F/38-49° C) to remove any residue left in seams or on surface.



Finish system removal using motor driven abrasives may generate airborne particles and toxic dust, which may injure personnel and create a possible dust explosion. All aerospace and motorized ground equipment shall be properly electrically grounded. Personnel shall wear dust particle masks, goggles, gloves and long sleeved shirts when using motor driven abrasives. Consult Bioenvironmental Engineering Services for respiratory and ventilation requirements.



Avoid excessive pressure or repeated passing over the same area while sanding. Excess sanding can cause damage to the surface of the aircraft.

#### NOTE

Some residual amounts of old coating system may be left after stripping (i.e., fastener heads, seams, hinges, surface porosity, etc.). These areas are acceptable as long as they are feathered into the surrounding surface.

- a. Lightly sand aircraft and feather sand the rough areas of the aircraft with 240-grit sandpaper.
- b. Remove all tape adhesive residue using solvent, denatured alcohol or isopropyl alcohol.

#### NOTE

If rinse facilities are not available, solvent wipe using denatured (O-E-760/MIL-A-6090, Type III) or isopropyl (TT-I-735) alcohol on clean lint-free cotton rags (CID A-A-59323) is an acceptable substitute process.

### 3.1.21 Application of PreKote SP.



Personnel shall wear full rain gear, face shield and rubber gloves to remain dry during the application of PreKote SP.



PreKote SP shall only be applied when temperature is maintained between 65° F/18 C and 110° F/43 C, and humidity is between 10% and 90%. Coating system failure may result if these conditions are not met.

- a. Mask aircraft IAW the any weapons system requirements for preparation of surfaces prior to painting. PreKote SP SP may be applied by pressure sprayer, spray bottle or fluid feed attached to sander. Use 180-grit scrub pads (A-A-58054 Type 1, Class 1, Grade B abrasive mat) attached to pneumatic sander to agitate.

- b. Apply and agitate first coat of PreKote SP in small sections (approximately 16 square feet per person working an area).

**NOTE**

Do not allow PreKote SP to dry prior to rinse.

- c. Rinse area with water.
- d. Repeat Paragraph 3.1.21 step a and Paragraph 3.1.21 b until entire area to be painted has been covered.
- e. Apply the second coat of PreKote SP with pressure sprayer or spray bottle. Area of application should not be so large as to allow the PreKote SP to dry prior to scrubbing.
- f. Scrub with 180-grit scrub pads on sanding poles until a rich lather is formed.
- g. Let the second coat of PreKote SP static air dry on the aircraft surface.
- h. Spray the third coat of PreKote SP with a pressure sprayer or spray bottle. Area of application should not be so large as to allow the PreKote SP to dry prior to scrubbing.
- i. Scrub aircraft with sanding poles and 180-grit scrub pads.



It is important that the entire third coat be completely removed. Coating failure may result if this application of PreKote SP is not completely removed.

- j. Thoroughly rinse the surface of the aircraft with deionized water. Rinsing shall immediately follow scrubbing. Scrubbed areas shall not be allowed to dry prior to use.
- k. Remove all masking.

**NOTE**

Deionized water is preferred for this final wipe/rinse but not mandatory.

- l. Thoroughly rinse aircraft for second time.



Maximum time allowed prior to repaint is 48 hours. Excess time prior to paint application will cause degradation of surface condition. To avoid damage to the PreKote SP and surface of the aircraft, all personnel shall wear cotton booties when on aircraft from this point forward.

- m. Let the surface of the aircraft static air dry.

**3.1.22 Use of PreKote SP on Exterior Surfaces Where Paint and Primer Have Been Removed During Scuff Sand, Touch-up or Repair.** PreKote SP may be used on exterior aluminum parts as an alternative surface preparation for MIL-C-5541/SAE AMS-5541 chemical conversion coating, and corrosion removal treatment requirements (MIL-M-3171, SAE-AMS-M-3171, MIL-C-38334/SAE AMS-1640 prior to prime and paint.

- a. Prepare exterior surfaces per Paragraph 3.1.21.



Finish system removal using motor driven abrasives may generate airborne particles and toxic dust, which may injure personnel and create a possible dust explosion. All aerospace and motorized ground equipment shall be properly electrically grounded. Personnel shall wear dust particle masks, goggles, gloves and long sleeved shirts when using motor driven abrasives. Consult Bioenvironmental Engineering Services for respiratory and ventilation requirements.



Avoid excessive pressure or repeated passing over the same area while sanding. Excess sanding can cause damage to the surface of the aircraft.

**NOTE**

Some residual amounts of old coating system may be left after stripping (i.e., fastener heads, seams, hinges, surface porosity, etc.). These areas are acceptable as long as they are feathered into the surrounding surface.

- b. If area to be prepared is adjacent to old paint system, lightly sand entire bare metal area and feather edges where required using 240-grit sandpaper.
- c. Solvent wipe sanded area with denatured alcohol (O-E-760/MIL-A-6090, Type III) or isopropyl alcohol (17-1-735).
- d. Mask area where PreKote SP is to be applied so as to avoid contact with surrounding paint. Masking should extend to the outside edges of the feathered area or to the edge of the part being treated.



**NOTE**

- PreKote SP may be applied by pressure sprayer, spray bottle or fluid feed attached to sander.
  - The first coat of PreKote SP may be hand or pneumatic scrubbed using 180-grit scrub pads.
  - All coats of PreKote SP may be removed using a clean, lint-free cotton rag moistened with isopropyl or denatured alcohol, instead of rinse with water.
- e. Follow procedures outlined in application of PreKote SP, Paragraph 3.1.24.

### 3.1.23 Corrosion Removal Solution For Magnesium.

**WARNING**

- Do not allow rags, brushes, abrasive mats, or any other item soaked with A-A-55827 chromic acid or the chromic acid pickle solution prepared with it to come in contact with any organic solvent (MEK, acetone, paint thinner, A-A-59601/MIL-PRF-680 dry cleaning solvent, etc.); fire will result.
- A-A-55827 chromic acid and the chromic acid pickle solution prepared with it are highly toxic to the skin, eyes, and respiratory tract. Chemical splash proof goggles and/or face shield, chemical resistant rubber gloves and apron are required. Good general ventilation is usually adequate. Assure this operation has been reviewed by local Bioenvironmental Engineer. In case of eye or skin contact, flush with water immediately and report to the base medical facility.

Chromic acid pickle solution which is a mixture of A-A-55827 chromic acid in water may be used to remove surface oxidation and light corrosion from magnesium alloy surfaces. It is not adequate for removal of deep pitting, heavy corrosion, sand or other blast media residue, or the effects of blasting which will require use of one of the mechanical methods described in this chapter. If properly used, this chemical method removes much less metal causing much less reduction of sectional thickness than mechanical methods, but it shall not be used on parts containing copper or steel inserts unless they are completely masked off. Do not allow excessive amounts of anions such as chlorides, sulfates, or fluorides to build up in the solution; they tend to coat or etch the metal surface rather than removing corrosion products. Do not reuse old solutions; prepare fresh solutions for each separate removal operation.

- a. Mix 24 ounces of A-A-55827 chromium trioxide in enough water to make one gallon for each gallon of solution being prepared in a container fabricated from lead lined steel (any alloy), stainless steel (any CRES alloy), or 1100 aluminum alloy. For depot level operations only, a removable part that is being treated can be completely immersed in the solution with an immersion time ranging from one to 15 minutes at an operating temperature ranging from 190° F to 202° F (88° C to 94° C). For hand application with the solution at room temperature, the dwell time for the solution on the surface is 15 minutes minimum to 30 minutes maximum. Paragraph 3.1.21 step b through Paragraph 3.1.21 step d are for hand application. Paragraph 3.1.21 step e through Paragraph 3.1.21 step f apply to both the immersion and hand application methods.
- b. Mask off the surrounding areas, in particular to include all nearby operating mechanisms, joints, crevices, copper and/or steel inserts, and plated steel to keep the solution from attacking them.
- c. Apply the chromic acid pickle solution carefully to the corroded area with an A-A-289 acid brush.
- d. Allow the solution to remain on the surface for approximately 15 minutes for a solution at room temperature. Agitate the area with an A-A-289 acid brush having half the bristle length cut off or a A-A-58054, Type I, Grade B or C abrasive mat.
- e. Thoroughly rinse the solution from the surface with plenty of fresh tap water.
- f. Repeat the preceding sequence as necessary until all corrosion products have been removed and the metal is a bright metallic color.

### 3.1.24 Surface Treatment Process For Magnesium.

**WARNING**

Chromic acid solution is highly toxic to the skin, eyes and respiratory tract. Avoid all contact. Skin and eye protection and vapor controls are required. Assure this operation has been reviewed by local Bioenvironmental Engineer.

Chemical pretreatment solution provides a passive surface layer with an inhibitive characteristic that resists corrosive attack and also provides a bond for subsequent coatings. The solution consists of the following materials and must be mixed in the ratio specified:



Water to make	1 gal
Chromic Acid Solution (Also known as Dow 19)	
Chromium Trioxide (A-A-5587 Type III) (99.5% pure)	1 1/3 oz
Calcium Sulfate (CaSo4 <sub>4</sub> •2H <sub>2</sub> O)	1 oz
Operating Temperature	70° F to 90° F
Container	Stainless steel, Aluminum, vinyl Polyurethane or rubber

**WARNING**

Rubber gloves, acid apron, and eye protection shall be worn by personnel during all mixing operations.

- a. Add chemicals to the water in the order shown, stirring the solution vigorously, either mechanically or by air agitation for at least 15 minutes.
- b. Apply the solution to a properly prepared surface using a brush, clean rag, sponge, applicator bottle, or a low pressure stream (flow-on, do not atomize). Apply the solution to the surfaces treated with the acid pickle solution while these surfaces are still wet. Allow the gross amount of rinse water to run off the aircraft, but do not wait for complete drying before applying Chromic Acid Solution, as the oxide film just removed by the acid pickle solution will reform during this time period and prevent a proper formation of the conversion coating. When applying solution to large areas start at the lowest surface working upward, applying the solution with a circular motion to disturb the surface film and assure proper coverage. Agitation shall be accomplished using a non-metallic acid resistant brush or aluminum oxide abrasive nylon mat (A-A-58054, Type I, Class 1, Grade A). Solution works best when applied at 70° F or above. Leave solution on the surface one to 20 minutes, until a dark brown coating is produced. Rinse with cold running water while insuring complete flushing of any residual materials.

**3.1.25 Surface Preparation For Steel.** It is essential to remove rust, scale, oil or other contaminants from steel surfaces to be painted. The Organic or Inorganic Zinc Rich primers require good electrical contact with the steel (these primers provide galvanic protection). To enable this, the steel surfaces shall be solvent cleaned per Table 3-2, phosphoric acid treated (Reference TO 1-1-691), or sandblasted. Sandblasting to white metal is preferred. Where sandblasting is not practicable or possible, clean surfaces by means of powered wire brushes, disc-sanders, grinding wheels or needle scalers. (Reference TO 1-1-691). Grind sharp edges to a rounded contour. Remove dust, sand, or grit by vacuuming with a HEPA filtered vacuum. Follow this with a solvent wipe per Table 3-2. Clean galvanized surfaces with power tools.

**3.1.26 Masking.** Masking off areas is almost invariably required in painting operations on large assemblies or structures either for protective reasons, as in the precautionary note below, or for purposes of delineation. In spray application of coatings, masking operations may consume more man-hours than the actual painting.

**NOTE**

To prevent overspray or paint drift of one color or material onto another, untreated Kraft paper may be used to mask or cover areas not specifically described below where protection of an area against overspray is the prime consideration.

**3.1.26.1** Mask areas such as windows, canopies and large openings with combinations of tapes and barrier materials:

- Specification MIL-PRF-121, usually a treated paper which is oil and moisture resistant.
- Specification MIL-PRF-131, usually a laminated foil and cloth or foil and paper with good water vapor resistance.

**NOTE**

Both types above are heat sealable.

**3.1.26.2** Pressure-sensitive masking tape conforming to SAE AMS-T-21595 (formerly MIL-T-21595), Types I (creped paper backing), II (flat paper backing), and III (plastic backing).

**CAUTION**

Care should be taken when cutting and trimming of the barrier/tape to prevent damage to any transparent plastic and glass surfaces.

**NOTE**

For general large area masking use either Type I or Type II. For operations involving sharp, fine line color separation such as aircraft markings and two tone gloss color schemes, use Type III tape only. This tape is designed to prevent edge bleeding and is more flexible for masking shapes, curves, etc.

- a. Cover small or irregular shaped parts with tape alone. Use pressure-sensitive masking tape conforming to SAE AMS-T-21595 (formerly MIL-T-21595), Types I and II.
- b. In repetitive spraying of the same or similar structures it is advisable to have available predesigned bandages, socks, etc., of barrier paper or cloth. Locally manufactured foam plugs or inserts may be used to protect aircraft inlet areas (e.g., scoops, air intakes, engine intakes, etc.) from painting as a replacement for masking and barrier paper. It is recommended that MIL-PRF-26514, protective ion material, be used in the making of foam plugs/inserts. One side of the plug should be covered in replaceable plastic or barrier material for easy cleanup.

**NOTE**

Care should be taken to ensure that paint is not applied to certain surfaces where paint will interfere with a function. The following should be masked or otherwise protected during painting: Machined surfaces that move with respect each other such as threads, bearing contacts and gear teeth; electrical parts, such as contacts, relays, insulators, sockets, plugs, connectors, wiring and terminals; plastic and rubber (natural and synthetic) mounts, spacers, etc., and lubrication fittings, cups, oil holes, etc.

- c. Avoid using tape in such a way as to leave a paint edge on aerodynamic surface unless feathering by sanding can safely be done.
- d. Use only approved masking tapes in varying widths required by the job. A complex curved area is better masked initially at the paint edges with narrow (1/4 or 1/2 inch) tape. Wider tape may then be applied over the narrow, if required.

- e. Use only approved masking paper for large area masking. Coating solvents may dissolve and deposit printing ink from newspapers, etc., on surface of the area being masked.
- f. When spray painting, mask or cover surfaces at a distance from the area being painted which might receive overspray or paint drift.
- g. Masking tapes should be removed as soon as possible after coating application to allow edges of coating to heal and draw down as much as possible.
- h. Press tape firmly when applying it to prevent paint bleeding under it by capillary action.

3.1.27 Tack Ragging.

**WARNING**

Exercise extreme caution in applying protective finishes to parts and equipment which may contact propellants directly or by accidental spillage. Critical areas may have to be masked. The guidance of applicable equipment technical manuals or engineering drawings shall be followed concerning use of protective finishes on parts or equipment used in or near propellant storage and transfer systems.

**CAUTION**

Commercial rental wiping cloths, laundered shop cloths, or disposable fiber or chemically treated paper wiping materials shall not be used.

To ensure that all primed surfaces are free from foreign matter, they should be tack-ragged immediately before applying the topcoat. Do not tack-rag an entire large structure at one time. Each area to be painted should be tack-ragged immediately prior to the application of finishing material to that area. Surfaces are gently wiped with the tack-rag, removing accumulations of dust and other foreign matter. One form of tack rag in common use to A-A-2522, Grade A, Color 1 dampened with an approved solvent per Table 3-2. Other commercially available forms of tack rag which are designed for the purpose of removing surface contamination from an area receiving paint may also be used. Do not use a tack-rag to clean more than 10 square feet at a time to prevent spreading any contaminants on the rag over a large surface.



## CHAPTER 4

### PAINTING APPLICATION METHODS

#### 4.1 GENERAL.

Spray application is the standard for painting Air Force aircraft and most other equipment. It is fast, and in the hands of skilled operators, produces films of good uniformity and quality. When application is described in this technical manual without specifying the method, High Volume Low Pressure (HVLP) spray application is implied. Methods other than spraying are useful in special cases, particularly in non-aeronautical or less critical applications. Brush or roller applications have their place and should be considered as alternate methods when used with suitable materials. The painters discretionary use of brush or roller for painting aerospace equipment should be based on local circumstances such as health or fire hazards. Additionally, there are some requirements which demand brush application, such as painting porous surfaces which require brushing-in for adequate coverage and penetration.

#### 4.2 SPRAY METHODS.

The Air Force uses several hand-operated spray methods: hot spray, cold and/or hot airless, air assisted airless, HVLP spray, and any of these methods in conjunction with electrostatics. The HVLP method is now the standard spray method used in the Air Force and meets the requirements of environmental regulations.

**4.2.1 HVLP Spray.** In this method, the coating material is atomized by a high volume of low pressure air through the spray gun nozzle. The HVLP spray equipment generally utilizes low pressure (below 20 PSIG) gun cups to assist in delivery of the coating material to the gun nozzle. Low pressure air between 1.0 and 10 PSIG is used to atomize the coating material at the spray head. A high volume of air is used to push the coating material and form a very soft, low-velocity pattern. This soft spray generally provides more consistent coverage and a better overall finish. The HVLP gun should be held closer to the surface (8 to 10 inches) than a conventional air spray gun because of the lower speed of the paint particles. The film thickness generated in a single coat is often greater than that of conventional air spray systems. This equipment shall not be used above 10 PSIG at the nozzle. Pressure should be checked regularly with a nozzle pressure gauge (see Figure 4-1).

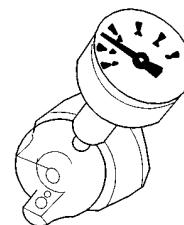

FO9603-01

**Figure 4-1. Nozzle Pressure Gauge**

**4.2.1.1 HVLP Touch-Up Spray Gun.** For minor touch-up and application of insignias and markings, a small HVLP spray gun may be used. While designed for applying quantities less than a quart, it has all of the advantages of the full size HVLP. It is also preferred over other aerosol power pack spray units for touch-up if an air source is available.

**4.2.2 Hot Spray.** Hot spraying is the application of coatings with HVLP, or airless spraying equipment, using heat as a substitute for all or a portion of the thinner ordinarily used to reduce coating materials to spraying viscosity. Hot spray is most frequently and effectively used with the airless spray system. Also, the hot paint, while cooled rapidly when atomized, retains sufficient heat to still be close to the ambient air temperature when it reaches the work surface. This reduces the possibility of blushing due to moisture condensation and allows spraying under conditions of relatively high humidity. However, a disadvantage is that heating the paint reduces its pot life.

**4.2.3 Airless Spray.** The term airless comes from the fact that no air pressure is used with this paint application method. Instead, hydraulic pressure is used to deliver the coating material, heated or unheated, to the gun head and atomize it by ejecting it from special spray nozzles. These nozzles increase the pressure by a factor of approximately 100. Atomization of the coating material and formation of the spray pattern are created by the gun nozzle. The droplets move toward the work surface by their momentum and are appreciably slowed down by air resistance. There is less bounce of the coating material on arrival at the work surface, and, therefore, less overspray. The cooling effect of expanding air associated with conventional spray is not present, so the only heat loss in the cold airless method is through solvent evaporation. In the hot airless method the material arrives at the work surface warmer than with other methods of spraying, usually at or above ambient air temperatures.

**4.2.4 Air-Assisted Airless Spray.** In this method the coating material is atomized by hydraulic pressure the same as airless spray but at a much lower pressure. Low pressure air is added at the gun head and directed at the paint mist to control and form the spray pattern. While the coating can be atomized at lower hydraulic pressure through the spray nozzle, proper spray pattern formation requires the assistance of the low pressure air through jets at the nozzle. This allows the operator control of the atomized coating pattern that cannot be done with standard airless. It offers almost equivalent advantages in spraying as the airless spray method, while being safer and requiring lower maintenance on pumps. These advantages are due to the lower hydraulic pressures used. In addition, the appearance of coatings applied by this method is better as the tendency to orange peel is lessened.

#### 4.2.5 Electrostatic Spray.



Electrostatic spray painting of JP-8 fueled aircraft constitutes a significant hazard when the on-board fuel temperature exceeds 100° F.

This method is a variation of the spray methods previously described which adds the feature of electrostatic charging (60,000 volts at about 200 microamps) of the paint material which is then attracted to the grounded workpiece. Charging of paint material can occur either inside the gun or at a fine metal probe at the gun nozzle exit (the most common method). Typically, this requires specially designed paint guns as most HVLP, airless, or air assisted airless guns cannot be modified to add this feature. This method is more effective with airless or air-assisted airless as the combination of low-particle velocity of the airless spray and the electrostatic attraction to the workpiece produces an excellent transfer efficiency rate. Electrostatic spray painting equipment can be powered by an external electrical source or a self-generating electrical source contained within the spray gun. Overspray is greatly reduced and hard-to-coat areas such as edges or geometric shapes are more effectively painted. The workpiece

(aircraft, etc.) is not charged electrically, but is grounded as in normal painting practices. This method has limited effectivity in coating interior corners, crevices, and cavities due to the Faraday effect, that causes charged paint particles to be repelled from the deepest points, and on some aircraft exterior surfaces, due to aluminum components being insulated by anodize, or due to composite materials that cannot be grounded. The safety precautions, operational parameters, and equipment maintenance for this method in Paragraph 5.5.3 must be strictly followed.

### 4.3 SPRAY PAINTING EQUIPMENT, GENERAL.

**4.3.1 HVLP Spraying Systems.** All HVLP spray systems have certain basic components necessary for their efficient operation. There must be an adequate source of compressed air, a supply of the finishing material from a reservoir or feed tank, a spray gun, and a device for controlling the combination of air and finishing material. Other refinements, such as an air-pressure transformer (regulator), air filter, water drain, hose cleaner, etc., are incorporated in the system to provide more efficient and satisfactory results. Figure 4-2, Figure 4-3, and Figure 4-4 are diagrams of complete spray systems.

**4.3.2 Spray Gun, General.** Spray guns are mechanical devices for atomizing or breaking-up coating materials into a spray and applying it under control, to a surface to form a continuous film. Figure 4-5 illustrates in sectional view of a typical spray gun. It is a precision instrument and must be treated as such. Its daily care and maintenance determine the effectiveness of spray painting. It should not be used by untrained personnel.

**4.3.3 Classes of Spray Guns.** HVLP spray guns are classed in three general types: suction feed, gravity feed and pressure feed. Each type is further subdivided by having either external or internal mix air caps. For the most part, the Air Force uses the external mix type.

**4.3.3.1** The suction feed (or siphon) cup gun is usually fitted with a fluid cup. Its nozzle assembly is designed to feed paint into the air-stream by the vacuum created from the air flowing past the fluid tip which protrudes into the air stream beyond the air cap. The amount of spraying at one time is limited to the contents of the cup. This gun is most commonly used in painting smaller areas, usually within the confines of a spray booth. (Figure 4-2, Detail B, illustrates suction feed hookup.)

**4.3.3.2** The pressure feed gun is designed to fluid feed to the gun under pressure from an external tank through a hose. The air cap and fluid tip are flush with each other, and no siphoning effect is necessary. It is suitable for high volume painting. (Figure 4-2, Detail A, illustrates pressure feed hook-up.)

**4.3.3.3** The gravity feed gun is designed with the cup located on the top of the spray gun. This allows paint to



completely drain, minimizing paint waste. Gravity feed guns supply paint to the orifice solely by means of gravity. The air pressure at the orifice of these guns is typically 40 to 50 psi.

**4.3.4 Material Containers.** Two types of containers serve as material reservoirs for spray guns, the cup and the tank. Both cups and tanks are available with agitators to provide constant mixing to keep materials in suspension during application. Agitators are mechanically operated by either an air or an electrical powered motor. See Chapter 6 to determine which coatings require agitators.

**4.3.4.1** Cup containers are used when small quantities of paint are to be sprayed. They are generally of the suction type

with a small vent on top of the container through which atmospheric pressure operates to force material up to the fluid tip when a compressed air stream creates a vacuum at the spray opening.

**4.3.4.2** Pressure feed tanks are used for high volume painting. Pressure feed tanks are tightly closed metal containers of varying size (2 to 120 gallons) that provide material at a uniform pressure and a constant rate of flow. Compressed air is directed into the tank to force the material out. Air pressure must be increased or decreased to change the rate of flow.



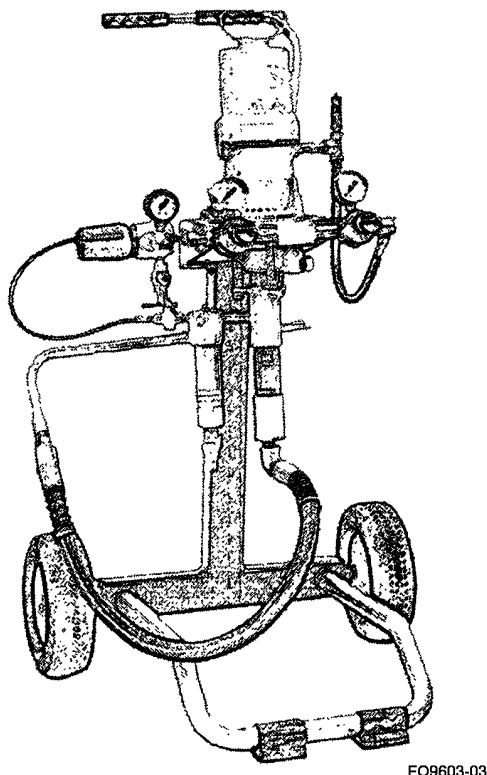

FO9603-03

**Figure 4-3. Airless Spray System**

**4.3.5 Air Compressors.** Air compressors provide a continuous supply of compressed air at a predetermined maximum pressure and a minimum volume in cubic feet per minute. There are two general types of air compressors, single stage and two stage. These can be further subdivided into many types such as portable or stationary, electric motor or gas engine driven, unloader or pressure switch controlled, and air or water cooled.

**4.3.6 Air Regulators or Transformers.** A regulator is a device equipped with indicator gages which reduces the main line air pressure to a lower regulated pressure. It also provides outlets to which spray guns and other air operated equipment may be connected. It must be capable of providing 15 cfm of air at 80 PSI (supply line pressure) with a maximum pressure drop of 10 PSI.

**4.3.7 Air Condensers.** An air condenser is similar to the air transformer and separates oil and moisture from the

air. A condenser is usually equipped with pressure gages, but may be found without gages where a regulated supply of air is available.

#### **NOTE**

Air condensers and transformers shall be drained at least daily and more frequently in humid weather.

**4.3.8 Air Supply.** Figure 4-6 illustrates proper installation of an air supply for paint spraying.

**4.3.9 Hose.**



Hoses shall always be thoroughly cleaned by flushing with solvent appropriate for the coating material used. When the material is a catalyzed (two component) system (epoxy or polyurethane), this must be done immediately after use to prevent the material from curing in the hose.

Because of friction losses in hose, it is essential that the proper size and length be used. Do not use hoses longer than 50 feet. High-pressure air hose leading from the air source to the regulator or tank which may be a maximum of 150 feet if required to reach the tail surfaces of exceptionally large aircraft. Extra lengths of hose may be attached for this use but shall be removed as soon as no longer needed. The high-pressure air hose shall have a minimum inside diameter (ID) of 7/16 inch. The fluid hose from the tank to the gun shall be no less than 3/8 inch ID and the air hose from the regulator to the tank and from the tank to the gun shall be no less than 5/16 inch ID. Any reduction in size or increase in length may produce unsatisfactory results. Air and paint hoses are furnished in various standard lengths.

#### **4.4 SPRAY PAINTING.**

**4.4.1 Gun Techniques.** Spray guns are designed to be used with certain spraying techniques. The quality of finish that is applied will depend on how well these techniques are used by the painter. Spraying techniques include the following:

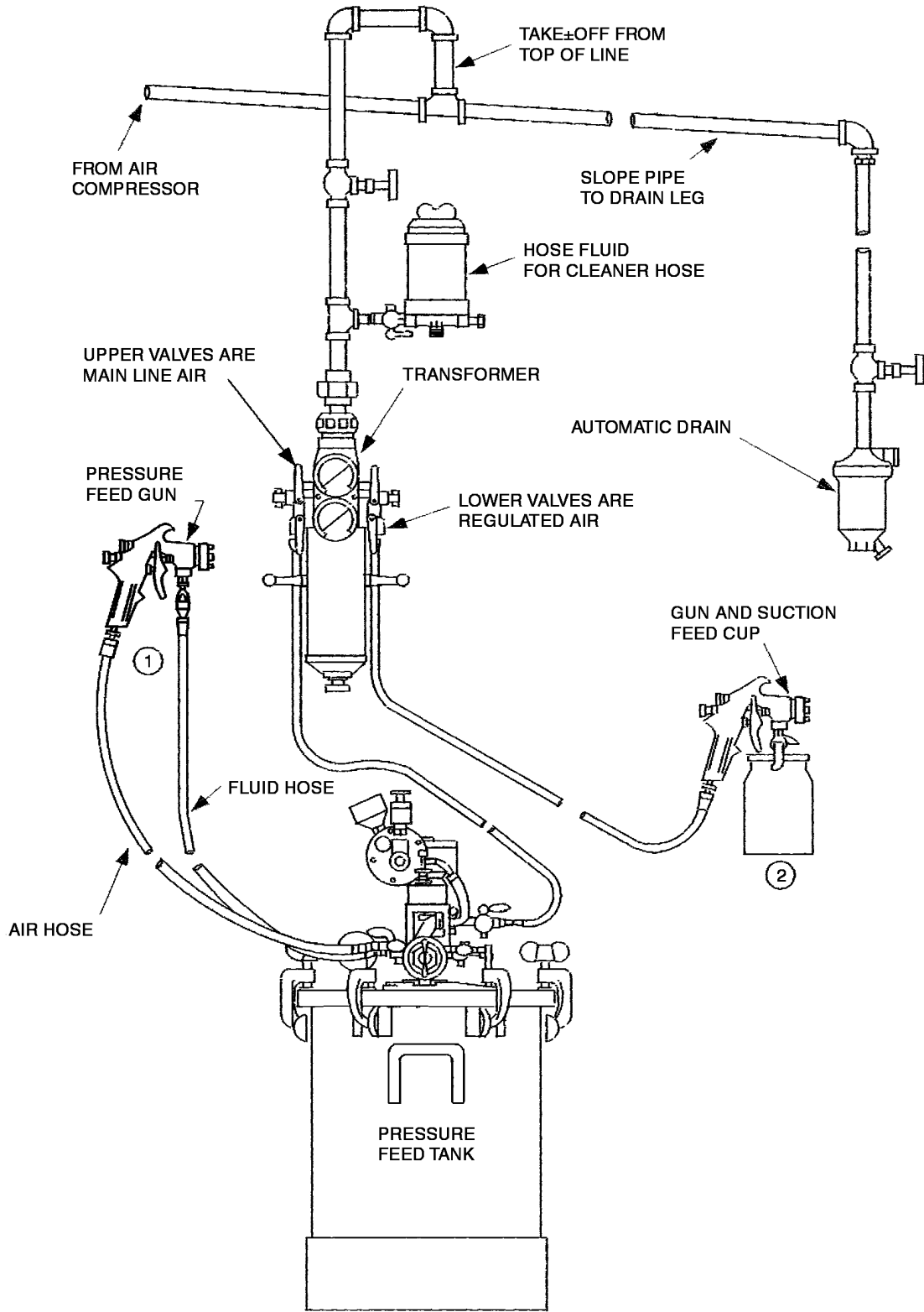

FO9603-04

Figure 4-4. Complete Spray System

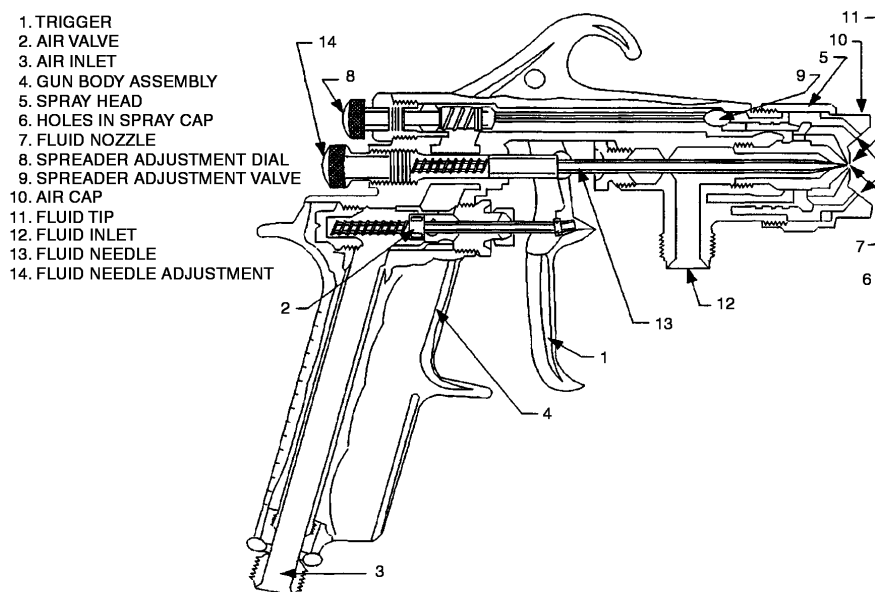

FO9603-05

**Figure 4-5. Sectional View of Spray Gun**

**4.4.1.1 Distance.** Distance depends on the desired width of the paint fan and the type of gun used (Figure 4-7, Detail A). When all adjustments to the spray gun are correct and the spray gun is held at too great a distance from the surface, it will result in a dry spray (dusting) and excessive overspray. Conversely, if the spray gun is too close to the surface, it will result in too heavy a coating with a tendency for sags or runs to develop.

**4.4.1.2 Stroking.** The essence of proper stroking is to maintain as near as possible the same distance to the work, the same speed, and the same perpendicularity of the gun to the surface throughout the pass. The natural tendency for spray painters, particularly when fatigued or in an uncomfortable position is to arc or wave the gun (Figure 4-7, Detail B). This practice must be avoided at all costs. In general, wrist movement must be eliminated in stroking as almost inevitably, it causes the gun to describe a curve instead of remaining perpendicular to the surface. This results in a thicker coating in the middle of the stroke than at the end. An exception to the rule is spotting in for touch-up. In this case it is permissible to fan the gun to produce an area which is thinner at the edges in order to blend into the surrounding painted area. When applying coating materials with poor flow

characteristics (such as vinyl paints), special efforts must be taken to hold the gun perpendicular to all surfaces (flat or contoured). If this is not done, the irregular spray pattern formed will produce an uneven thickness and cause uneven drying. Protrusions such as screw heads, etc., present surfaces that will require facing the gun in several directions to completely coat them. It may be advisable to spot paint these in advance. The rate of the stroke should be uniform to produce a full wet coat of material. Stroking should be in parallel passes with each stroke aimed for a 50 percent overlap, or so that the middle of the spray pattern strikes the wet bottom edge of the previous stroke (Figure 4-8). In order to ensure good coating integrity and coverage, the technique of cross coating is best (Figure 4-9). Cross coating should always be used when applying multiple coats of a coating system. This is done by applying each layer using the 50 percent overlap and cross coating with each alternate layer of the coating system, usually after a drying or curing period between coats. The cross-coating technique is also the standard for applying a single-coat finish system by applying a thin, wet-coat followed immediately with another thin cross-coat to obtain one full wet coat. When applying high solids primers and topcoats, with HVLP, airless, or air assisted airless equipment, a single coat using 50 percent overlap



without a cross coat may be used. The process control must be adequate to prevent holidays or other finish defects that may result from a single heavy application.

**4.4.1.3 Triggering.** Proper triggering of the gun is difficult to learn. The variations of triggering technique which may be called for in special situations can only be developed by practice. It is a matter of judgment and experience. In general, the painter should begin his stroke before triggering the gun and release the trigger before stopping the stroke. It can be compared to the follow-through in swinging a golf club. This tends to feather out the end of a stroke so that the end of a succeeding overlapping stroke blends into it. Examples of correct techniques are shown in Figure 4-7.

**NOTE**

- A reasonable amount of care will maintain spray guns and spray equipment in top operating condition and prevent a majority of spraying difficulties. Thorough cleaning immediately after use and appropriate lubrication are essential.
- This manual provides only general spray gun information. See specific manufacturer's booklet or manual for detailed operating and maintenance instructions.

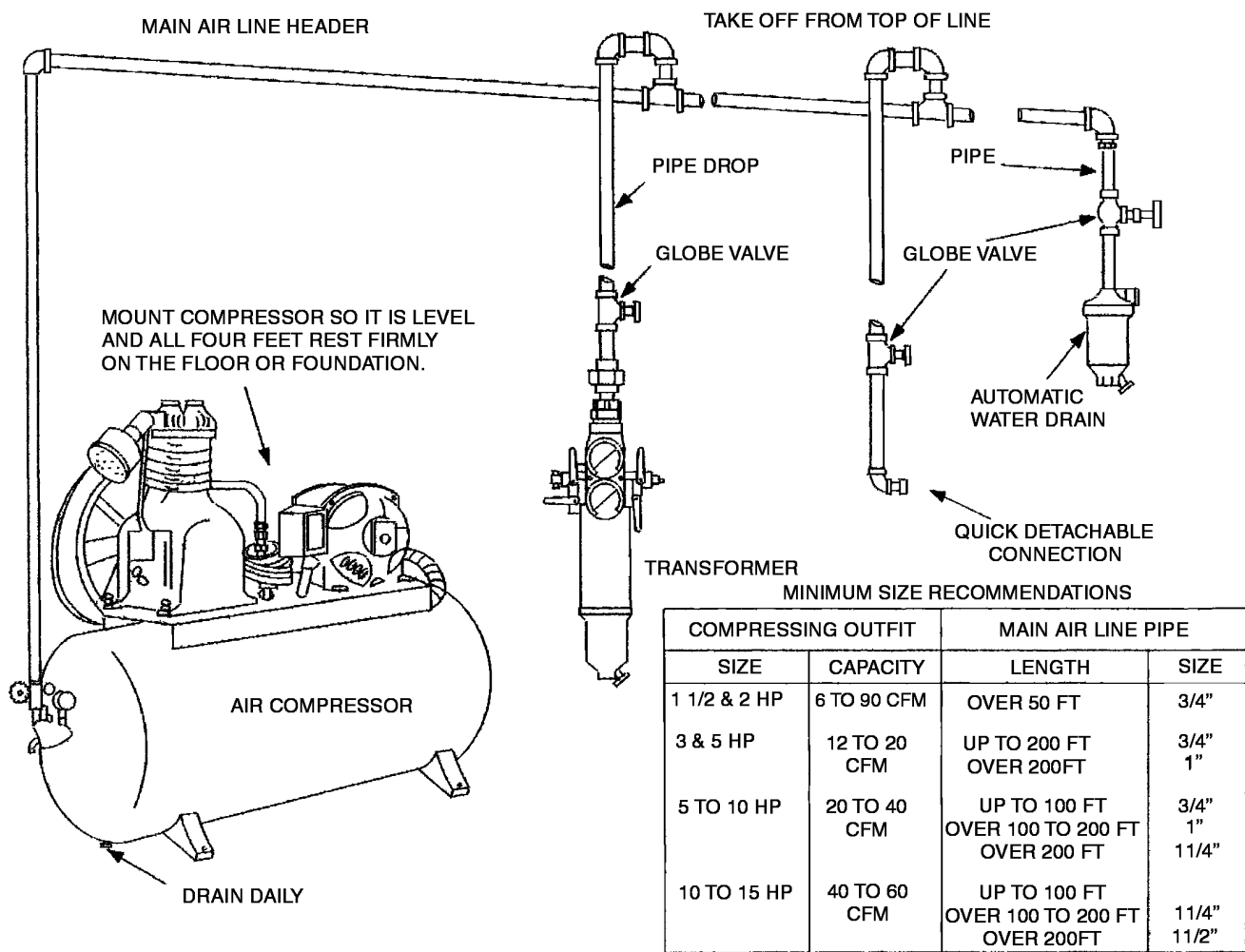

FO9603-06

Figure 4-6. Proper Installation of Air Compressor, Piping

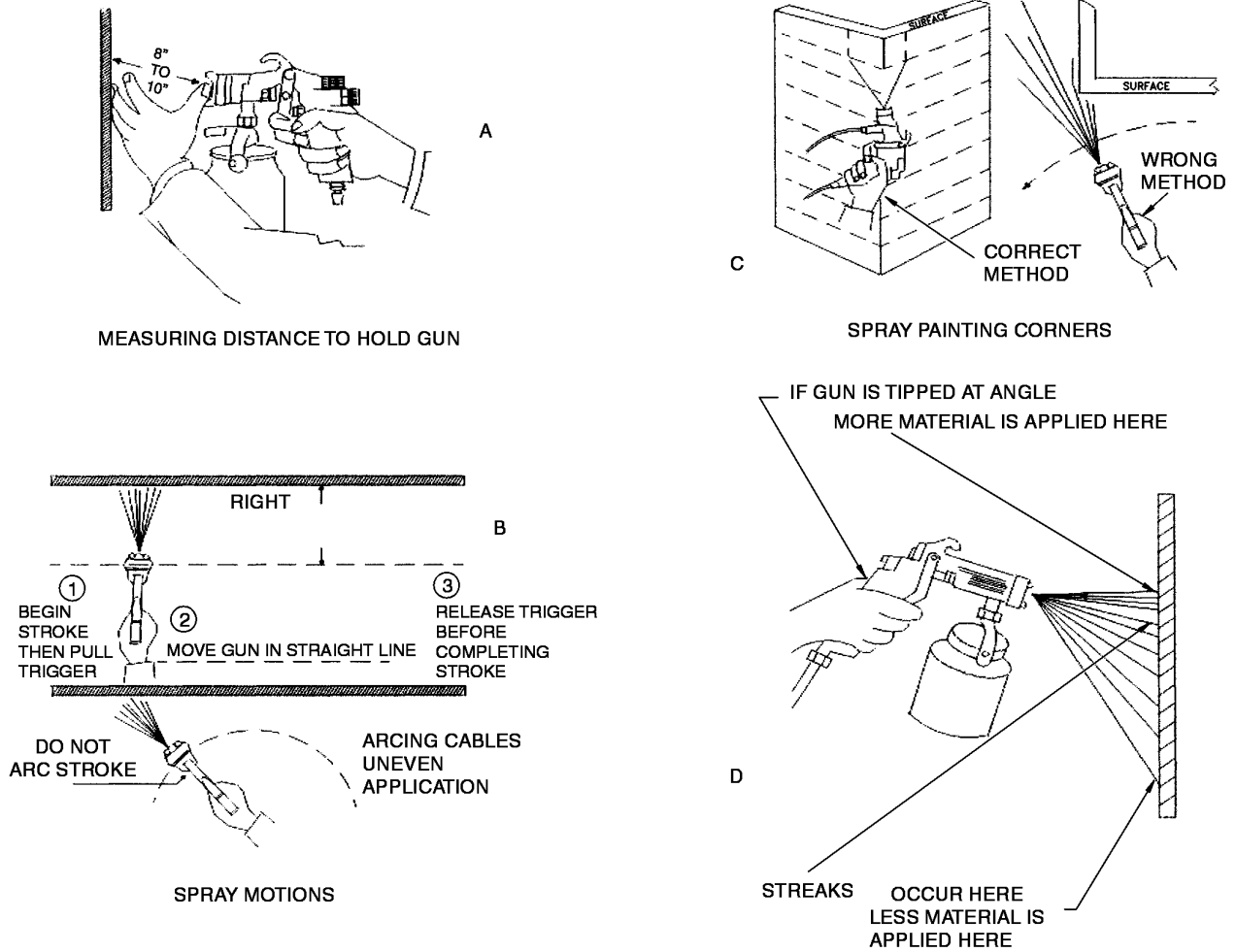

FO9603-07

Figure 4-7. Right and Wrong Methods of Spraying

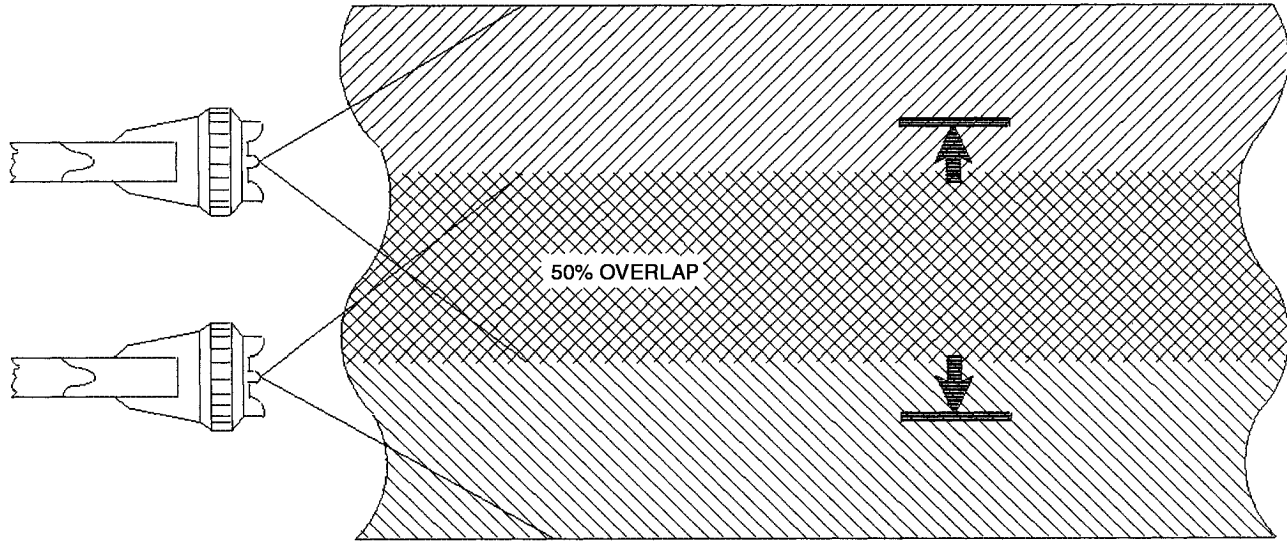

FO9603-08

Figure 4-8. Fifty Percent Overlap

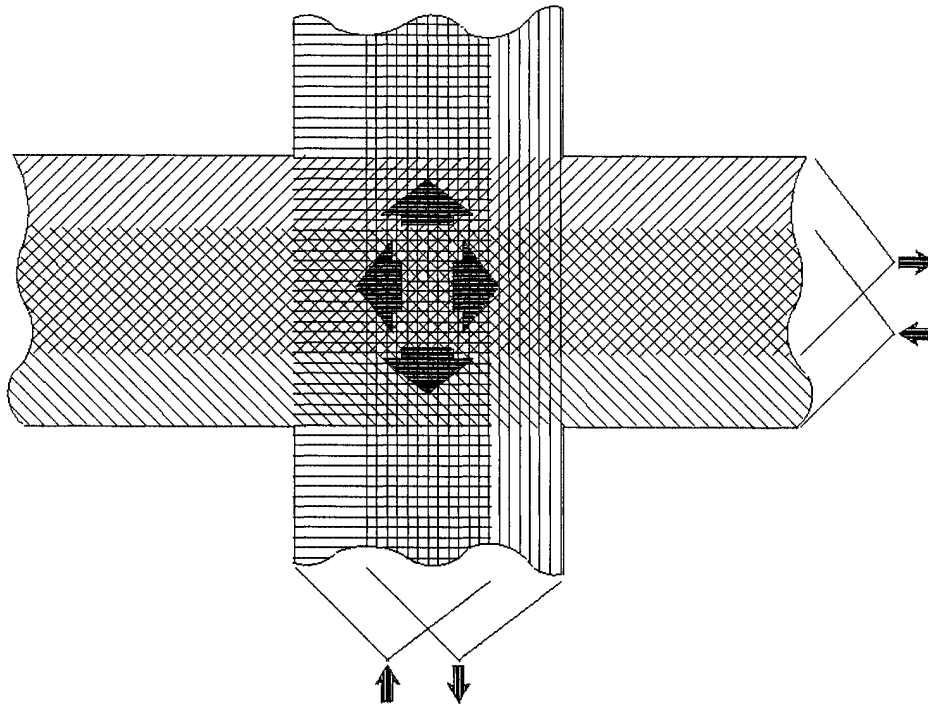

HALF OF TOTAL COATS SHOULD BE CROSS-COATED

FO9603-09

Figure 4-9. Cross Coating

4.4.2 **Gun Adjustments.** The flow of air and fluid at the gun must be adjusted or balanced to obtain proper atomization and other desired spraying characteristics.

4.4.2.1 The first consideration in obtaining this balance is the proper combination of air cap and fluid tip for the particular material being sprayed as recommended by the equipment manufacturer and the coating material manufacturer.

4.4.2.2 After the air cap and fluid tip have been selected, there are several adjustments which may be made with the gun controls to properly adjust the air and fluid relationship. These adjustments are necessary to obtain proper atomization and other desired spraying characteristics required for the job and conditions. The fluid adjusting screw on the gun (Figure 4-10, B) permits restriction of fluid flow relative to the volume of air being used, but is limited since it puts additional tension on the gun trigger and tends to discourage feathering at the beginning and end of the stroke.

4.4.2.3 For pressure feed spraying, adjustment of tank pressure and adjustment of the atomization air supply to the gun is more effective for obtaining the proper air to fluid balance.

4.4.2.4 The air adjustment screw (Figure 4-10, A) can be changed to spread the atomized fluid out over a greater area, which, in combination with the increased air flow, is equivalent to reducing the flow of fluid.

4.4.2.5 The correct atomizing pressure depends on the type of coating and the length and diameter of the air line from the regulator to the gun. The pressure must be sufficient to completely atomize the material being sprayed but no greater. For HVLP paint guns, the regulator pressure shall be adjusted to a lower level to ensure the nozzle pressure does not exceed a maximum of 10 PSI per Paragraph 4.2.1. An excessive amount of air may give a split pattern in which the material deposited is light in the middle of the pattern; too little air may give a heavy centered pattern. Pressure on the paint pot is usually adjusted to a range of 25 to 40 PSI but may vary more widely, depending on the density of the paint and the elevation of the surface being painted above the pressure tank. In normal operation, the wings on the nozzle are in the horizontal position which provides a vertical fan-shaped pattern for maximum coverage as the gun is moved back and forth parallel to the surface being painted. The spray pattern is variable from round to flat with all patterns in between and can be adjusted to obtain the pattern which produces the best results.

#### NOTE

As the width of the spray is increased, more paint must be allowed to pass through the gun to get the same coverage.

#### NOTE

Do not thin the paint excessively to increase the flow of fluid.

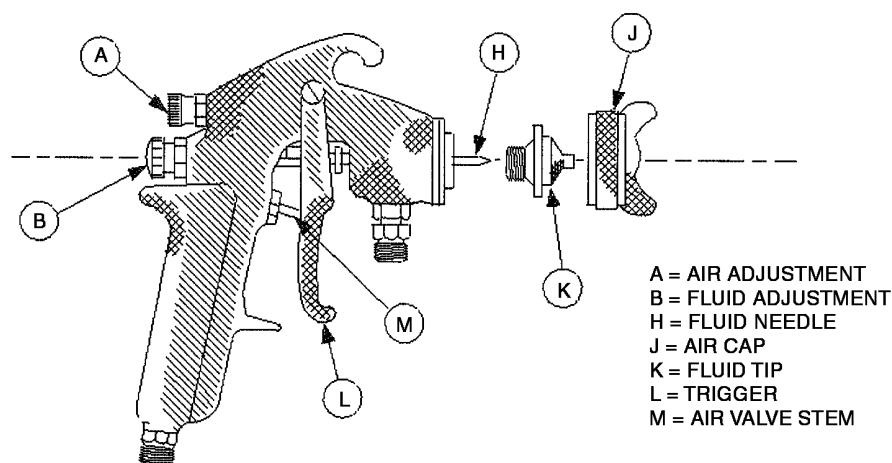

FO9603-10

Figure 4-10. Spray Gun Adjustments

4.4.3 Painting Difficulties and Remedies. Coating troubles may be divided into five groups: (1) Inadequate surface preparation, (2) Incorrect methods or techniques of application, (3) Unusual climatic or atmospheric conditions, (4) Unsuitable equipment, and (5) Faulty finishing material. Inadequate surface preparation is self-explanatory and is discussed in Chapter 3. Incorrect methods of application should be discontinued upon discovery of the discrepancy. Remedying incorrect techniques of application, however, calls for training. The practice of allowing inadequately trained personnel to apply coatings, particularly to aeronautical surfaces, is unauthorized and dangerous. Conditions such as adverse weather and humidity may cause the application method chosen to be unworkable. Unusual climatic and atmospheric condition can to some extent be remedied or compensated for by temperature and humidity controls, shielding from elements, etc. Consideration should always be given to alternative methods such as hot spraying or even brushing and roller coating on certain surfaces. Unsuitable or faulty equipment can only be remedied by obtaining proper equipment or repair. An experienced painter may be capable of compensating for faulty materials to obtain proper results, but this is an emergency measure only and must be with the cognizance and authority of the quality control facility. Table 4-1 and Figure 4-14 through 4-22 lists common troubles of spray coating operations with suggested remedies or methods of avoidance.

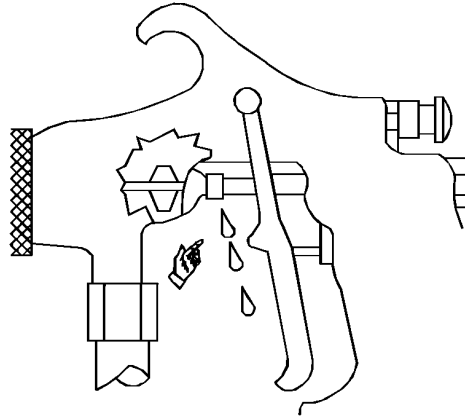

FO9603-12

Figure 4-12. Paint Leaks From Spray Gun

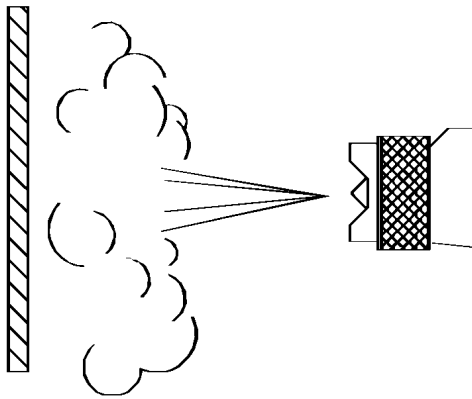

FO9603-11

Figure 4-11. Excessive Spray Fog



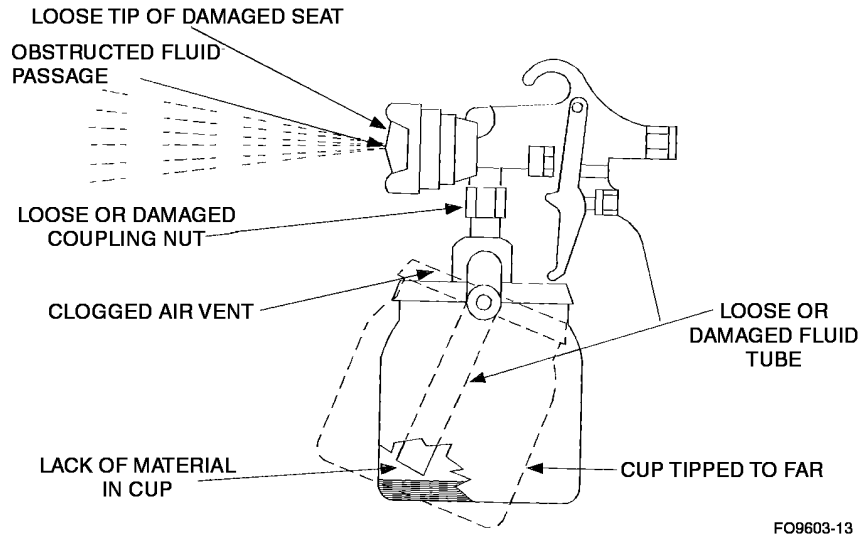

Figure 4-13. Gun Sputters Constantly

Table 4-1. Spray Coating Troubles, Possible Causes, and Remedies

Trouble	Possible Causes	Preventive Measures Or Remedies
Sags and Runs	<ol style="list-style-type: none"> <li>1. Dirty air cap and fluid tip (distorted spray pattern).</li> <li>2. Gun stroked too close to the surface.</li> <li>3. Trigger not released at end of stroke (when stroke does not go beyond object).</li> <li>4. Gun stroked at wrong angle to surface.</li> <li>5. Coating material too cold.</li> <li>6. Coating applied on too heavily.</li> <li>7. Coating material thinned excessively.</li> </ol>	<ol style="list-style-type: none"> <li>1. Remove air cap and clean tip and air cap carefully.</li> <li>2. Maintain 8 to 10 inches for HVLP gun distance from surface.</li> <li>3. Release the trigger after every stroke.</li> <li>4. Keep gun at right angle (perpendicular) to surface during stroke.</li> <li>5. Heat material by approved methods.</li> <li>6. Develop ability to apply correct thicknesses by panel practice.</li> <li>7. Add the correct amount of solvent by measure or determine by viscosity test.</li> </ol>
Streaks	<ol style="list-style-type: none"> <li>1. Dirty air cap and fluid tip (distorted spray pattern).</li> <li>2. Insufficient or incorrect overlapping of strokes.</li> <li>3. Gun stroked too rapidly (dusting of the paint).</li> <li>4. Gun stroked at wrong angle to surface.</li> <li>5. Stroking too far from surface.</li> <li>6. Too much air pressure.</li> <li>7. Split spray.</li> <li>8. Coating material too cold.</li> </ol>	<ol style="list-style-type: none"> <li>1. Remove air cap and clean tip and air cap carefully.</li> <li>2. Follow the previous stroke accurately. Deposit a wet coat.</li> <li>3. Avoid whipping. Make deliberate, slow strokes.</li> <li>4. Keep gun at right angle (perpendicular) to surface during stroke.</li> <li>5. Maintain 8 to 10 inches for HVLP gun from surface.</li> <li>6. Use least air pressure necessary.</li> <li>7. Clean the fluid tip and air cap.</li> <li>8. Heat material to get good flow-out.</li> </ol>

**Table 4-1. Spray Coating Troubles, Possible Causes, and Remedies - Continued**

Trouble	Possible Causes	Preventive Measures Or Remedies
Paint will not come from Spray Gun	<ol style="list-style-type: none"> <li>1. Out of paint (gun begins to sputter).</li> <li>2. Settled, cake pigment blocking gun tip.</li> <li>3. Grit, dirt, paint skins, etc., blocking gun tip, fluid coatvalve or strainer.</li> </ol>	<ol style="list-style-type: none"> <li>1. Add paint, correctly thinned out and strained.</li> <li>2. Remove obstruction, stir paint thoroughly.</li> <li>3. Clean spray gun thoroughly and strain the coating material. Always strain materials before using.</li> </ol>
Paint will not come from Pressure Tank	<ol style="list-style-type: none"> <li>1. Lack of proper air pressure in the pressure tank.</li> <li>2. Air intake opening inside of pressure tank lid, clogged by dried-up material.</li> <li>3. Leaking gaskets on tank cover.</li> </ol>	<ol style="list-style-type: none"> <li>1. Check for leaks or lack of air entry. Set correct pressure.</li> <li>2. This is a common trouble. Clean the opening periodically.</li> <li>3. Replace with a new gasket.</li> </ol>
Paint will not come from Suction Cup	<ol style="list-style-type: none"> <li>1. Dirty fluid tip and air cap.</li> <li>2. Clogged air vent on cup cover.</li> <li>3. Using wrong air cap.</li> <li>4. Leaky connections on fluid tube or nozzle.</li> </ol>	<ol style="list-style-type: none"> <li>1. Remove air cap and clean tip and air cap carefully.</li> <li>2. Remove the obstruction.</li> <li>3. Ascertain and use correct set-up.</li> <li>4. Check for leaks under water and repair.</li> </ol>
Excessive Material Loss	<ol style="list-style-type: none"> <li>1. Not triggering the gun at each stroke.</li> <li>2. Stroking at wrong angle to surface.</li> <li>3. Stroking gun too far from the surface.</li> <li>4. Wrong air cap or fluid tip.</li> <li>5. Depositing a film of irregular thickness.</li> <li>6. Air pressure too high.</li> <li>7. Fluid pressure too high.</li> <li>8. Coating material too cold.</li> </ol>	<ol style="list-style-type: none"> <li>1. It should be a habit to release trigger after every stroke and retrigger to begin the next stroke.</li> <li>2. Gun should be stroked at right angles to surface and the stroke parallel to the surface.</li> <li>3. Stroke the gun 8 to 10 inches for HVLP gun from the surface.</li> <li>4. Ascertain and use correct set-up.</li> <li>5. Learn to calculate the depth of wet film of finish and develop control. Measure wet film thickness.</li> <li>6. Use the least amount of air necessary.</li> <li>7. Reduce pressure. If pressure keeps climbing, clean regulator on pressure tank.</li> <li>8. Heat to enable reduced air pressure.</li> </ol>
Excessive Spray Fog (Figure 4-11)	<ol style="list-style-type: none"> <li>1. Too high air pressure.</li> <li>2. Spraying past surface of the product.</li> <li>3. Wrong air cap or fluid tip.</li> <li>4. Gun stroked too far from the surface.</li> <li>5. Material thinned out too much.</li> </ol>	<ol style="list-style-type: none"> <li>1. Use the least amount of air pressure necessary.</li> <li>2. Release trigger when gun passes target.</li> <li>3. Ascertain and use correct set-up.</li> <li>4. Stroke the gun 8 to 10 inches for HVLP gun from surface.</li> <li>5. Add the correct amount of solvent by measure or test.</li> </ol>

Table 4-1. Spray Coating Troubles, Possible Causes, and Remedies - Continued

Trouble	Possible Causes	Preventive Measures Or Remedies
Paint Leaks from Spray Gun (Figure 4-12)	<ol style="list-style-type: none"> <li>1. Fluid needle packing nut too tight.</li> <li>2. Packing for fluid needle dry.</li> <li>3. Foreign particle blocks fluid tip.</li> <li>4. Damaged fluid tip or needle.</li> </ol>	<ol style="list-style-type: none"> <li>1. Loosen nut, lubricate packing.</li> <li>2. Lubricate this part daily.</li> <li>3. Remove tip and clean.</li> <li>4. Replace both tip and needle.</li> </ol>
Gun Sputters Constantly (Figure 4-13)	<ol style="list-style-type: none"> <li>1. Fluid nozzle not tightened to the spray gun.</li> <li>2. Leaking connection of fluid tube or needle packing (suction cup).</li> <li>3. Fluid pipe not tightened to the pressure tank lid.</li> </ol>	<ol style="list-style-type: none"> <li>1. Tighten securely, using a good gasket.</li> <li>2. Tighten connections; lubricate packing.</li> <li>3. Tighten. Check for defective threads.</li> </ol>
Orange Peel (Figure 4-14)	<ol style="list-style-type: none"> <li>1. Coating material not thinned out sufficiently.</li> <li>2. Coating material too cold.</li> <li>3. Insufficient air pressure.</li> <li>4. Using wrong air cap or fluid nozzle.</li> <li>5. Gun stroked too far from the surface.</li> <li>6. Overspray striking a previously sprayed surface.</li> </ol>	<ol style="list-style-type: none"> <li>1. Add the correct amount of solvent by measure or viscosity test.</li> <li>2. Heat material to get flow-out.</li> <li>3. Increase air pressure or reduce fluid pressure.</li> <li>4. Select correct air cap and nozzle for the material and feed.</li> <li>5. Stroke the gun 8 to 10 inches for HVLP gun from surface.</li> <li>6. Spray detail parts first. End with a wet coat.</li> </ol>
Sandpaper Finish (Figure 4-15)	<ol style="list-style-type: none"> <li>1. Unsatisfactory wash primer or primer.</li> <li>2. Excessive dirt contamination from painting area.</li> <li>3. Insufficient scuff-sanding of primer.</li> <li>4. Improperly cleaned paint lines.</li> <li>5. Dried overspray, gun too far from surface.</li> </ol>	<ol style="list-style-type: none"> <li>1. Laboratory analysis to verify acceptability of the material; check wash primer and primer application procedures.</li> <li>2. Provide cleaner painting areas.</li> <li>3. Scuff-sand primer using No. 320 and No. 400 wet or dry sandpaper.</li> <li>4. Flush paint lines frequently with solvent.</li> <li>5. Sand the complete finish until smooth to the fingertips. Stroke gun 8 to 10 inches for HVLP gun from the surface.</li> </ol>
Wrinkling (Figure 4-16)	Caused by applying too thick a coating, this prevents uniform drying of the coat and thus results in formation of ridges and furrows.	Material should be applied in thin uniform coats. If a thick coating is necessary, it should be applied by spraying several thin coats until the desired thickness is obtained. Allow each coat to set before applying the next.

**Table 4-1. Spray Coating Troubles, Possible Causes, and Remedies - Continued**

Trouble	Possible Causes	Preventive Measures Or Remedies
<p>Crazing, Mud Cracking, Checking (Figure 4-17 and Figure 4-18).</p> <p>These three defects are all very similar in that they all consist of surface cracks in varying degrees. Crazing is a fine surface crack while cracking and checking often extend to the metal surface.</p>	<ol style="list-style-type: none"> <li>1. Painting over a hard glossy coat. A base coat of this condition offers a poor surface adhesion of subsequent coats. In drying, the topcoat slides over the base coat, breaking out in cracks.</li> <li>2. Excessive amount of catalyst in paint causing brittleness.</li> <li>3. Excessive heat employed in drying operation.</li> <li>4. Insufficient drying times between coats.</li> </ol>	<ol style="list-style-type: none"> <li>1. Remove all previous coats of paint using paint remover or scuff sand, solvent wipe, and apply a primer tiecoat before overcoating.</li> <li>2. Drier should be used only as recommended by manufacturer of material being used.</li> <li>3. Exercise caution in placement of heat lamps to assure uniform heat distribution over the entire painted area.</li> <li>4. Allow sufficient drying times.</li> </ol>
<p>Slow drying of Wash Primer</p>	<p>Accidental addition of A-A-857 thinner; excessive butyl alcohol addition; high humidity conditions, excessive thickness; denaturants in the alcohol such as oils, high boilers, etc., introduced by the accidental use of the wrong alcohol to clean the surface.</p>	<p>Check mix, using smaller quantities of same batch, apply to test panel; modify the type and/or quantity of thinner added and compare drying times under actual painting conditions; incorporate use of small test panel adjacent to all aircraft during complete painting procedure, using such panel for thickness measurements also.</p>
<p>Pinhole Cavities, Solvent Pop</p>	<p>Improper surface treatment or lack of surface treatment; entrapped oils and/or solvents; insufficient primer drying times; excessive alcohol additions to wash primer; use of improper thinner.</p>	<p>Apply manual surface treatment and ensure complete coverage with surface chemical film, before wash primer and/or primer application; check mixing instructions to eliminate use of improper thinners.</p>
<p>Excessive Blushing of Topcoats.</p>	<p>Excessive humidity; insufficient quantity of Specification blush-retardant thinner ASTM D330.</p>	<p>Check humidity control equipment where employed and/or increase quantity thinner ASTM D330.</p>
<p>Peeling</p>	<p>Failure to remove moisture, oil or grease from the surface before the finish is applied.</p>	<p>Refinish surface.</p>
<p>Blistering (Figure 4-19)</p>	<ol style="list-style-type: none"> <li>1. Oil or grease on surface.</li> <li>2. Moisture in lines.</li> <li>3. Trapped solvents.</li> </ol>	<ol style="list-style-type: none"> <li>1. Strip and clean; or sand down and repaint.</li> <li>2. Drain lines periodically.</li> <li>3. Use proper thinner.</li> </ol>

Table 4-1. Spray Coating Troubles, Possible Causes, and Remedies - Continued

Trouble	Possible Causes	Preventive Measures Or Remedies
Inconsistent Coloring	Pigment not evenly distributed as a result of settling or insufficient mixing.	Apply additional coats after thoroughly mixing the finish material.
Defective Spray Patterns (Heavy Center)	<ol style="list-style-type: none"> <li>1. Setting too low on fan adjustment.</li> <li>2. Air cap; atomizing pressure too low.</li> <li>3. Pressure feed: Fluid pressure too high for normal capacity of air cap.</li> <li>4. Nozzle too large for fluid used.</li> </ol>	<ol style="list-style-type: none"> <li>1. Adjust fan adjusting valve.</li> <li>2. Adjust atomizing pressure.</li> <li>3. Adjust fluid pressure.</li> <li>4. Replace nozzle with correct size.</li> </ol>
Defective Spray Patterns (Split Spray)	Air and fluid feeds not properly balanced.	Reduce width of spray pattern by means of the spreader adjusting valve, and if condition is not remedied, increase fluid pressure. The latter increases rate of material flow. Readjust atomizing pressure, fluid pressure, and spray width until desired spray is obtained.
Defective Spray Patterns (Heavy Top or Bottom) (Heavy Right or Left)	<ol style="list-style-type: none"> <li>1. Horn holes partially clogged. Obstruction on top or bottom side of nozzle.</li> <li>2. Dirt on air-cap seat or nozzle fluid tip seat.</li> </ol>	<ol style="list-style-type: none"> <li>1. Determine location of obstruction by rotating air cap one-half turn and spray a new pattern. If defect is reversed, obstruction is in air cap; if not reversed, it is on the nozzle of fluid tip.</li> <li>2. Clean. Check for burrs and dried paint in opening.</li> </ol>
Starving the Spray Gun	<ol style="list-style-type: none"> <li>1. Insufficient air because of waste filter in transformer too tightly packed or clogged.</li> <li>2. Aircocks, hose or pipelines too small.</li> <li>3. Inadequate air supplies from too small a compressor or a break in the system.</li> </ol>	<ol style="list-style-type: none"> <li>1. Repack or replace filter.</li> <li>2. Replace with units of adequate size.</li> <li>3. Obtain a compressor of adequate size or repair leakage.</li> </ol>
Failure of Wet Tape Test	Insufficient drying time for wash primer and/or primer; insufficiently cleaned surface; cleaning compound residue, etc. Oil seepage through inspection doors or fasteners; entrapped oils and soil in shop applied temporary primer; insufficient removal of shop primer and/or previous coatings; use of final finishes incorporating wax ingredients; use of laundered rags instead of new lint free cotton rags; seepage of water containing cleaning in compound residues from between faying surfaces.	Employ solvent wipe down, per Chapter 2; remove any shop primers to provide a clean aluminum surface prior to any painting; employ solvent-dampened cloths in lieu of dry cloths for removal of oil contamination (especially along jet engine inspection doors); conduct laboratory analysis to determine primer acceptability; allow aircraft to stand for sufficient time to permit drainage of effluent before final cleaning; note the type of failure, such as to bare metal intercoat failure, and select the applicable remedy according to the cause of failure.



**Table 4-1. Spray Coating Troubles, Possible Causes, and Remedies - Continued**

Trouble	Possible Causes	Preventive Measures Or Remedies
Fish-Eyes and Poor Wetting, Crawling, Poor Flowout. (Figure 4-20)	<p>Use of waxes or sealants and adhesives containing silicones. Presence of other types of oils, greases, or hydraulic fluids on the surface.</p> <p style="text-align: center;"><b>NOTE</b></p> <p style="text-align: center;">Minute quantities of silicones can cause this film.</p>	Solvent clean with silicone-removing compounds.
Lifting (Figure 4-21)	<ol style="list-style-type: none"> <li>1. Absorption of solvents by previous partially dried film.</li> <li>2. Second coats apt to lift if surface is poorly prepared.</li> <li>3. Use of lacquer over enamel.</li> <li>4. Use of lacquer thinner in enamel.</li> </ol>	<ol style="list-style-type: none"> <li>1. Allow coats to dry/cure for the proper dry to over-coat time before recoating for epoxies, polyurethanes, and lacquers; with enamels either allow first coats to dry completely, or apply second coats immediately.</li> <li>2. Begin with properly prepared surface.</li> <li>3. Use compatible coatings and thinners. Enamel may be applied over lacquer but lacquer may not be applied over enamel.</li> <li>4. Use compatible coatings and thinners. Enamel may be applied over lacquer but lacquer may not be applied over enamel.</li> </ol>
Pitting or Cupping (Figure 4-22)	<ol style="list-style-type: none"> <li>1. Rust under surface.</li> <li>2. Oil or grease on surface.</li> <li>3. Moisture in lines.</li> <li>4. Trapped solvents.</li> </ol>	<ol style="list-style-type: none"> <li>1. Strip and clean; or sand down and repaint.</li> <li>2. Strip and clean; or sand down and repaint.</li> <li>3. Drain lines periodically.</li> <li>4. Use proper thinner proportions and allow proper cure times.</li> </ol>

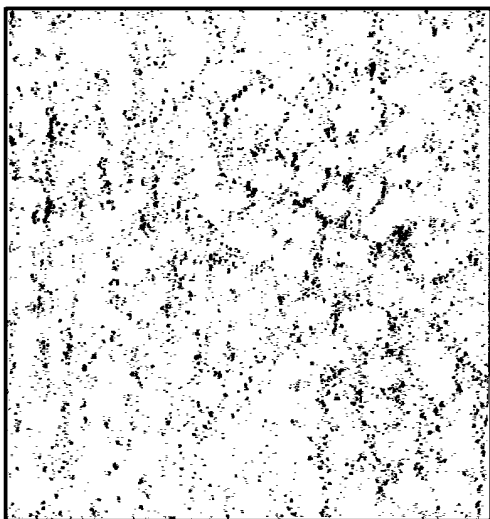

FO9603-14

**Figure 4-14. Orange Peel**

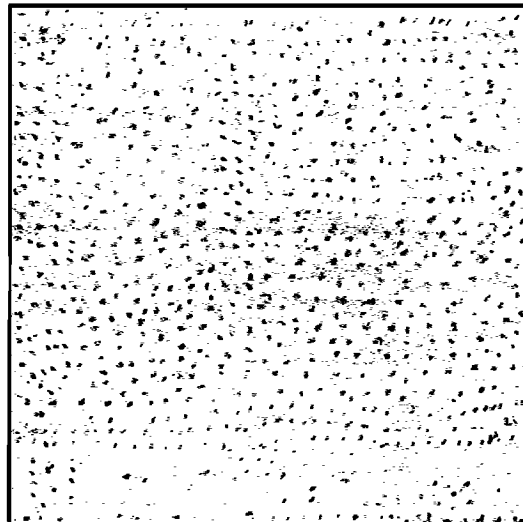

FO9603-15

**Figure 4-15. Sandpaper Finish**

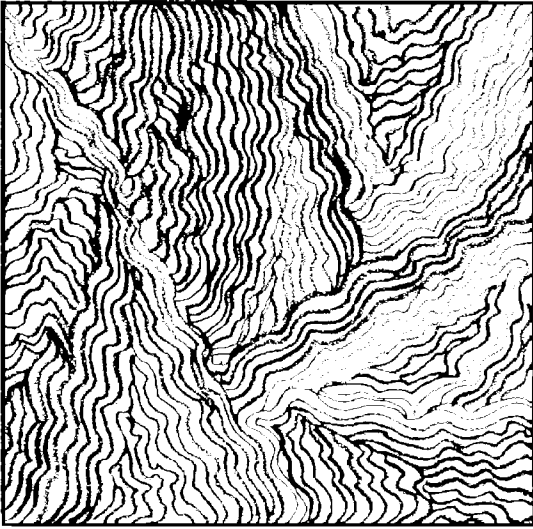

FO9603-16

Figure 4-16. Wrinkling

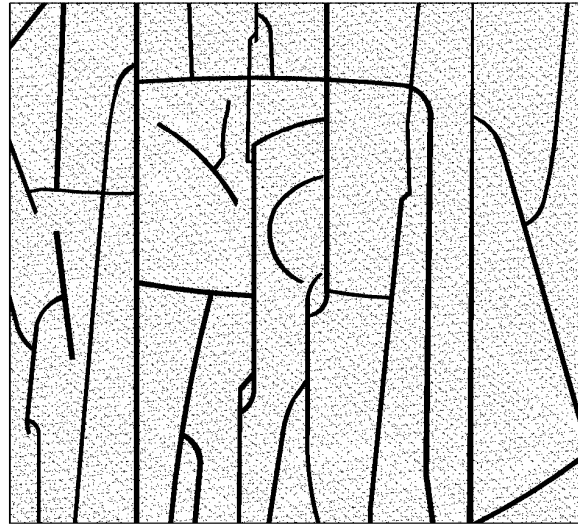

FO9603-18

Figure 4-18. Cracking

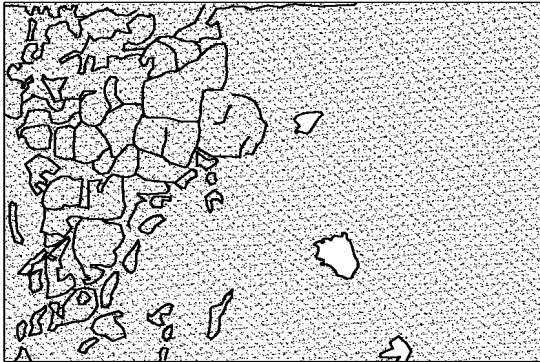

FO9603-17

Figure 4-17. Crazing

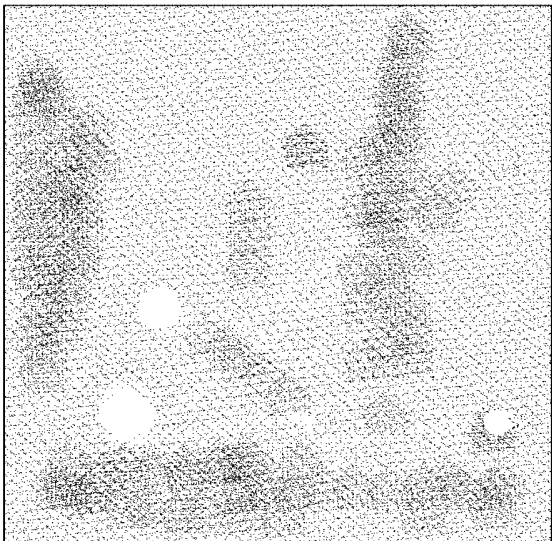

FO9603-19

Figure 4-19. Blistering

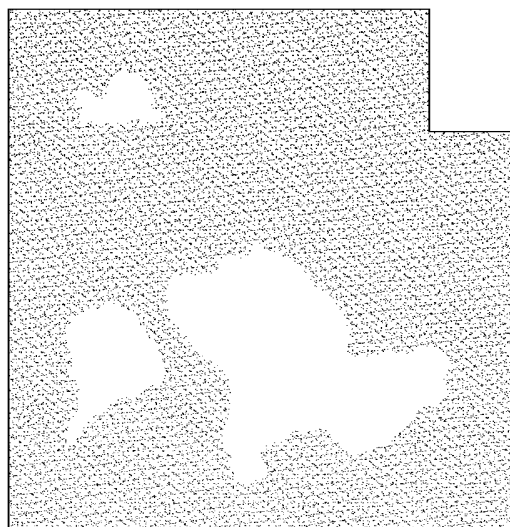

FO9603-21

Figure 4-21. Lifting

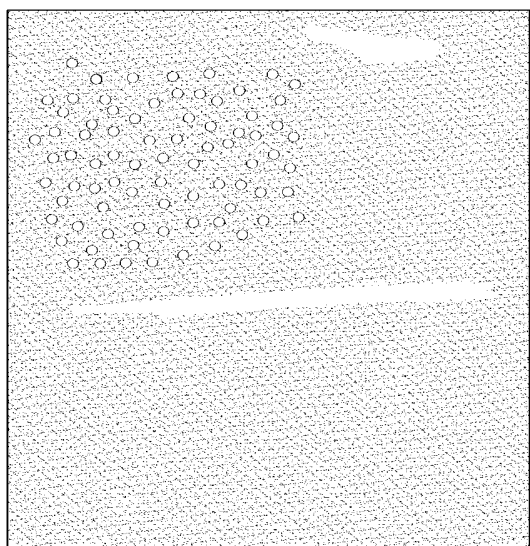

FO9603-20

Figure 4-20. Fish Eyes

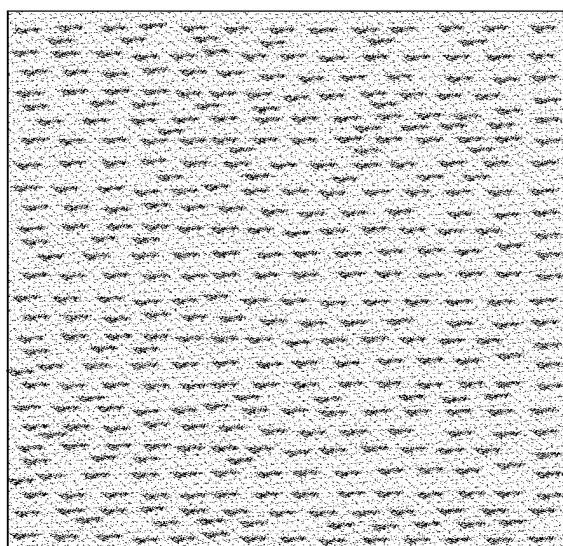

FO9603-22

Figure 4-22. Pitting or Cupping

4.5 CLEANING AND MAINTENANCE.

Proper maintenance of spray guns is necessary to preserve the life of the gun and ensure high quality results. The gun requires little other maintenance if kept clean.

- a. Basic maintenance consists of occasional lubrication. The packing surrounding the air valve stem shall receive a few drops of light oil to maintain easy movement of the air valve. The packing enclosed in the packing nut around the fluid needle shall be lubricated for easy movement of the fluid needle assembly. The spring for the fluid needle assembly shall be coated with petrolatum per VV-P-236 (Vaseline®). In addition to lubrication, parts that experience wear, such as air nozzles, fluid nozzles, and needle assemblies, should be periodically replaced.

**NOTE**

Excessive tightening of the packing nut will damage the packing and the needle valve assembly.

- b. After each paint job, the gun shall be thoroughly cleaned with thinners/solvents listed in Paragraph 4.6. If cleaning is delayed, the time needed to clean the gun is greater, and there is a potential for damage to the equipment.

**WARNING**

When using solvents, keep away from heat and open flame, keep container closed, use only with adequate ventilation, and use gloves to avoid skin contact.

- (1) To clean a siphon-feed gun, unscrew the air cap and release the paint cup from around the siphon tube at least a distance of 1 or 2 inches. Hold a cloth over the air cap and trigger the gun. Air will be sent into the passageways, forcing any excess paint back down the siphon tube and into the loosened paint cup.
- (2) Remove the paint container and clean the inside using MIL-T-81772, Type I or II thinner or TT-T-2935 purging thinner or one of the lower vapor pressure solvents listed as preferred alternatives for these in Paragraph 4.6.

**CAUTION**

Abrasive materials and chemical strippers shall not be used to clean spray gun parts, as damage to the gun will result.

- (3) Fill a quarter of the clean container/cup with the same type of thinner or solvent (fresh/unused) used to clean it.
- (4) Remove the air nozzle and carefully lower it into the container/cup of thinner or solvent.
- (5) Using a nonmetallic bristle brush, clean the fluid nozzle openings and other parts of the gun that are difficult to reach, such as around the packing nuts and controls.

**CAUTION**

Do not submerge the gun in thinner or solvent as they can dry out the packing around the fluid and air stems.

- (6) Dampen a rag with thinner or solvent and wipe the entire gun and cup until they are free of paint.
- (7) Using the bristle brush clean the air nozzle and its openings.
- (8) Put the gun back together, and spray clean MIL-T-81772, Type I thinner only through the gun until a fan of clear thinner is produced. Do not use the lower vapor pressure solvents listed in Paragraph 4.6 for this final flushing procedure for the same reasons noted in the CAUTION in Paragraph 4.6.
- (9) Remove any excessive thinner, and wipe the cup and gun with a clean dry rag.

**NOTE**

A spray gun contains parts that must work together. Dismantling a spray gun after each paint operation will cause excessive damage to the gun and its seals. A spray gun should only be dismantled when a proper spray pattern cannot be produced.

4.6 MECHANICAL PAINT GUN WASHER.

When lower vapor pressure solvents are used to clean paint guns and their paint supply lines/hoses, the paint guns must be blown out with clean, compressed air and the lines/hoses must be flushed with MIL-T-81772, Type I thinner immediately after they are removed from the paint gun washer and prior to use to eliminate all traces of these solvents from the guns and lines/hoses. These solvents are not compatible with the paints and primers used on Air Force equipment, and failure to remove them will contaminate the next paint system applied with the paint gun and supply lines/hoses and cause fish eyes and other paint curing problems.

**NOTE**

It is highly recommended that an initial hazardous waste collection container be located as near as possible to the paint gun cleaner so that any contaminated sludge, solvents, and filters may be immediately placed in the container without having to transport the waste to the collection container.

The most effective method for cleaning paint spray guns, paint fluid hoses, and paint pots/cups is by using a mechanical paint gun washer. These washers use either MIL-T-81772, Type I or II thinner, TT-T-2935 Parachlorobenzotrifluoride (PCBTF), purging thinner, or other low vapor pressure solvents, that contain some VOCs but no HAPs. The solvents are contained in a closed-loop system, consisting of a cover, reservoir, sump, pneumatic pump, spray nozzles, pneumatic controls, and either a filtration or a distillation system. The container has devices installed inside of it for connecting paint guns for cleaning of internal as well as external surfaces. Since these washers are closed loop systems, their use reduces hazardous waste, volatile organic compound emissions, solvents required to manually clean the paint equipment, and hazards to the personnel. Use of paint gun washers is required to comply with NESHAP rules when applicable.

- a. Equipment fitted with a filtration system reutilizes the solvent until it is so soiled that it must then be replaced, and it also requires periodic change out of the filters. These units are recommended for paint shops with a medium to low production rate and a high personnel turnover rate such as many field level maintenance organizations. The filtration type paint gun cleaners are relatively simple to operate and require only a minimum amount of personnel training for safe and effective operation. There should be at least two people in each paint shop that are proficient in the operation of the shop's paint gun cleaner so that personnel turnover will not result in a situation where there are no trained operators present in the shop. Operation of this equipment shall be in accordance with the manufacturer's instructions.

**NOTE**

- For proper disposal of contaminated solvent, contact local civil engineering authorities for instructions.
  - Solvent replacement shall be done in accordance with manufacturer's instructions.
  - Contaminated filters are considered hazardous waste and shall be placed in a hazardous waste collection container immediately after removal from the paint gun cleaner.
- b. Equipment fitted with a distiller recycles the solvent and separates out the waste and does not require solvent disposal. These units are recommended for paint shops with a medium to high production rate and a relatively stable work force such as found in most depot level maintenance organizations. The distillation type paint gun cleaners are relatively difficult to operate and require a higher degree of personnel training than the filtration type units for their safe and effective operation. There should be at least two people in each paint shop that are proficient in the operation of the shop's paint gun cleaner so that personnel turnover will not result in a situation where there are no trained operators present in the shop. Operation of this equipment shall be in accordance with the manufacturer's instructions.





## CHAPTER 5

### PAINTING OPERATIONS FOR AIRCRAFT AND EQUIPMENT

#### 5.1 GENERAL.

This chapter describes coating application procedures for aircraft and equipment used by the Air Force. Except when otherwise directed by this technical order or by local requirements or limitations, protective organic coatings may be applied by spraying, brushing, or any other approved method which results in continuous adherent films. The method selected or directed for application of coatings to aerodynamic surfaces shall be developed and adjusted to provide film integrity, optimum adherence, smoothness and good appearance. Achieving acceptable finishes on airframe surfaces requires trained personnel plus certain disciplines of operation. Pre-planning for painting is an absolute requirement to provide a logical schedule of operations, arrange for a cleared working area, and have available painting aids such as scaffolding and cleanup materials and equipment, etc. Correctly preparing coating materials and maintaining painting equipment in good operating condition are as important as knowing the techniques of applying coatings.

#### 5.2 SAFETY AND HEALTH ASPECTS OF PAINTING.



Measures shall be taken to prevent paint waste from contaminating air, water, or soil. Some of the chemicals used in painting require treatment or other special control prior to disposal. Disposal of materials shall be accomplished under the direction of the Base Civil Engineer, Safety Office, Bioenvironmental Engineer, and Environmental Management Office in a manner that will not result in violation of local, state, or federal pollution criteria. Detailed information for disposal is cited in AFI 32-7040, AFI 32-7041, AFI 32-7042, AF PAM 32-7043, AFI 32-7080, and AFI 32-7086.

Painting operations are hazardous and require control or preventive measures. Vapors produced, particularly in spray painting, are usually highly flammable, as are the accumulated dried coating materials deposited on walls, floors, and equipment in the painting area. Also, coating materials and their thinners very often contain toxic substances which are

injurious to health by inhalation and, to a lesser degree, by skin contact. Painting operations also involve hazards of physical injury due to improper use of work stands, ladders, hoists, etc. As directed by the local Safety and the Bioenvironmental Engineers, all painting personnel shall observe all safety precautions regarding toxicity, other health, and flammability hazards specified by existing instructions and regulations. AFOSH STD 48-8 and 48-137; AFD 91-3; AFOSH STD 91-17, 91-25, 91-68, 91-119, and 91-501; AFI 91-301 and 91-302; and NFPA 10, 13, 33, and 91 apply, and all safety precautions in these documents regarding personnel health, fire prevention, ventilation, handling of equipment, electrical grounding, storage of coating materials, area preparation, use of vapor-proof lights, etc., are mandatory. Refer to Table 5-1 for the minimum recommended personal protective equipment. The following measures are minimum required practices for personal safety:

- a. Wear approved respiratory protective devices.
- b. Wear protective clothing to prevent contamination of ordinary clothing. When painting, use cloth coveralls with a head covering (sock hat) or hooded Tyvek coveralls, disposable rubber gloves, and non-slip foot coverings for walking on aircraft. Do not store protective clothing in the painting area. Store protective clothing in ventilated metal lockers in some other convenient location.
- c. After painting, wash hands thoroughly before eating. Do not carry food into spraying areas.
- d. Spray paint only in areas approved by Fire, Safety, and Bioenvironmental Engineering.

#### WARNING

Spray gun nozzles are sources of very high pressure. During operation and cleaning of paint spray guns, the nozzle shall never be pointed towards any person in close proximity.

- e. Spray painting equipment presents hazards of which painters should be aware. Consult manufacturers' instructions for proper handling, cleaning, operation, and precautionary procedures.

**Table 5-1. Minimum Recommended Controls and PPE for Priming and Painting Operations<sup>a</sup>**

Operation	Engineering Controls	Personal Protective Equipment					
		Respiratory	Hand	Ear	Eye	Body	Foot
Mixing	General dilution ventilation	None	Disposable Nitrile gloves	None <sup>b</sup>	Safety goggles or faceshield	Tyvek or cotton coveralls	Safety toe boots
Thinning	General dilution ventilation	None	Disposable Nitrile gloves	None <sup>b</sup>	Safety goggles or faceshield	Tyvek or cotton coveralls	Safety toe boots
Spray application	Paint spray booth/facility	Air-purifying with OV/N95 cartridges <sup>c</sup>	Disposable Nitrile gloves	None <sup>b</sup>	Safety goggles <sup>d</sup>	Tyvek or cotton coveralls	Safety toe boots
Curing	General dilution ventilation	None	None	None <sup>b</sup>	None	None	Safety toe boots
Sempen usage	General dilution ventilation	None	Disposable Nitrile gloves	None <sup>b</sup>	None	None	Safety toe boots

<sup>a</sup> Local Bioenvironmental Engineer may recommend more restrictive controls or PPE based on exposure monitoring

<sup>b</sup> Hearing protection may be required in locations where hazardous noise is produced from other sources

<sup>c</sup> A powered air-purifying respirator (PAPR) with hood is the best choice for spray paint application

<sup>d</sup> Not required if a full-facepiece or hooded respirator is worn

**5.2.1 Respiratory Protection.** Many toxic materials are found in spray painting shops which may impair the health of personnel if control measures are not provided. Harmful concentrations of these materials may be reduced to a safe level by an efficient mechanical exhaust system supplemented with personal respiratory protection. At a minimum, it is recommended that powered air purifying respirators with hood be used; however, always contact Bioenvironmental Engineering for selection of proper respiratory protection. It should be understood that a respirator is not a substitute for a proper exhaust system, but is a supplement to existing ventilation methods (refer to NFPA 91; and AFOSH 48-8, and 48-137).

#### NOTE

This manual provides only general information for respiratory safety devices. See the manufacturer's technical data for detailed operating and maintenance instructions. See the DO43 System for NSNs) and to convert specification and part numbers to NSNs. Equipment Authorization Inventory Data (EAID) authorization for equipment type items must be established in accordance with AFMAN 23-110, Volume 2, Part 2, Chapter 22.

### 5.3 SPRAY BOOTHS AND PAINTING AREAS, GENERAL.

Spray painting shall be conducted in a properly ventilated spray area such as in a spray booth which confines and exhausts vapors and mists and overspray during painting operations. Paint booths are available in various sizes for small parts painting, or for larger wheeled equipment, and can be large enough for complete aircraft. Air flow design shall provide adequate velocity at the face of the booth. Basic airflow criteria for a specific type paint booth is available from the Bioenvironmental Engineer. Also, see NFPA 91; "Industrial Ventilation, A manual of Recommended Practices" published by the American Conference of Government Industrial Hygienists (ACGIH), and AFOSH STD 91-17. For additional reference criteria, see the Air Force Corrosion Facility Reference Guide on the Air Force Corrosion Prevention and Control office's website. Doors and windows in the area should be kept closed to exclude dust and dirt. Air should enter a booth at a rate which will not cause turbulence or excessive air currents but be sufficient to keep dried overspray from settling on surfaces which have been painted and are still tacky. Humidity and temperature indicators shall be installed and kept in proper operation so that the temperature and humidity for correct spraying can be checked and maintained. Lighting shall amply illuminate all surfaces being painted, and all lighting and connecting electrical

switching shall be explosion proof. Spray room surfaces shall be cleaned frequently to ensure good housekeeping.

### 5.4 PAINT BOOTH TYPES.



Prior to spraying of paint, rigidly comply with all safety regulations regarding to electrical grounding, fire prevention, vapor and explosion-proof lights, etc.

Two types of paint spray booths are in general use, the dry type and the air-water wash type. Traditional spray booths are generally effective at removing particulate matter such as solid and liquid particles of overspray, but they do not remove solvent vapors from exhaust air. Removal of solvent vapors for air quality emissions compliance requires supplemental equipment to collect the organic vapors on activated charcoal filters or to destroy them by combustion or catalytic reaction. These special process capabilities are matters to be addressed by local civil engineering and environmental planning functions.

**5.4.1 Dry-Type Booth.** Dry-type spray booths draw contaminated air through a series of baffles or filters before exhausting it to the outside. Care should be taken to minimize air currents in the spray booth that will interfere with removal of spray dust or with the health and comfort of personnel. These booths are available with varying types of filter material, and local environmental regulations may specify the numbers of filter banks required. In most cases, the filter material will be considered a hazardous waste; and disposal should be coordinated with local civil engineering and environmental management.

**5.4.2 Air-Water Wash Type Booth.** In addition to the baffles used in the dry-type booth, this type of spray booth has a series of water curtains to trap and remove overspray solids and liquids from contaminated air before it is exhausted. An air-water wash type booth will remove up to 95 percent of paint residue before it is exhausted when working properly. Many areas today have greater restrictions than 95% efficiency. Fire hazards are greatly reduced when the air-water wash booth is used. A deflocculating material or water wash compound is added to the water to prevent residue from adhering to the working portion of the booth, and also serves to prevent rusting. A paint sludge removal system may be installed in these booths to decrease the frequency of changing the water. Disposal of paint sludge may be considered a hazardous waste and should be coordinated with local civil engineering and environmental management.

5.4.3 Cleaning and Maintenance. A suitable coating should be applied to all dry interior surfaces of a booth to facilitate cleaning. Paint residue which floats on the surface of the water should be removed each day to prevent it from settling to the bottom of the tank. Spray booths should be coated with an approved fireproof material. The applicable equipment manual should be consulted for complete information on paint spray booths. It is very important to keep the spray booth and its immediate vicinity as free from dirt and dust as possible. The strong suction created by the exhaust fan can pull dust from outside into the booth and may deposit it on sprayed surfaces.

5.4.4 Part and Equipment Painting Operations. All parts and equipment painted in spray booths shall be properly positioned in the booth. This is necessary to ensure the painter is not improperly exposed during the painting operation. The parts shall be placed on roll around tables or hung from roll around racks to allow for their repositioning in the paint booth during the painting operation. The painter shall spray into the face of the booth with the air flow from the painters back. When painting complex parts, change the position of the part being painted so that the painter is never spraying into the air flow. Painted parts shall be removed from the spray booth as soon as possible after the spraying has been completed and the vapors have been removed. When painting large equipment, the painter shall begin at the front or exhaust end of the booth and work toward the back or air supply end. This is to ensure the painter remains out of the flow of the paint overspray.

## 5.5 AIRCRAFT PAINTING OPERATIONS.

5.5.1 Depot Level Aircraft Painting Operations. Depot painting of aircraft shall conform to the following safety and health protection precautions:

### NOTE

Painting of entire aircraft will necessarily be accomplished in a variety of locations including interior areas not primarily designed for painting operations and out-of-doors. Insofar as applicable, all safety precautions and directions on environmental and materials controls pertain in these areas also. Painting in maintenance hangars shall be restricted to the minimum necessary to maintain the integrity of the coating system and shall always be under cognizance of local safety, fire and medical service representatives. Painting in maintenance hangar will be done IAW AFOSH STD 91-17.

- a. Base Fire, Safety, Bioenvironmental, and Environmental Management Offices shall approve locations for spray painting aircraft. Painting of fueled aircraft must be approved by the AFMC and the responsible ALC Fire Protection Engineering Offices, and is authorized only if the following precautions are taken. Aircraft containing JP-5, or JP8 fuel may be electrostatically painted during depot level operations, providing the on-board fuel temperature is below the flash point of 100° F before and during electrostatic painting operations. The aircraft being electrostatically painted must be grounded in two locations to prevent accidental electrical discharge from the electrostatic spray equipment. Each base is responsible for establishing procedures to ensure that the temperature of on-board fuel is below 100° F before and during electrostatic painting applications.
- b. The ventilation system must provide sufficient exhaust to remove the solvent vapors generated by the process. The exhaust stream shall be maintained below 20 percent of the Lower Explosive Limit (LEL) with no more than 500 ppm total solvent vapor concentration. The paint hangar facility shall be equipped with an audible alarm system which activates if the ventilation system fails. Personnel shall wear proper respiratory protection in addition to the ventilation as specified by Bioenvironmental Engineering.
- c. The painting equipment must be used only in the paint hangar and shall be of the HVLP, Airless or Air-Assisted-Airless Type and may employ electrostatic capabilities in accordance with EPA requirements.
- d. Painters shall be trained in the hazards associated with painting fueled and unfueled aircraft, and the fire and safety problems associated with the process.
- e. All safety and regulating features on associated spray painting equipment and safety equipment shall be operational.
- f. No unauthorized personnel are allowed in the paint hangar during fueled aircraft painting operations.
- g. Any personnel involved in operations in the paint hangar, even those not associated with the painting process, shall be briefed on the hazards of static on ungrounded objects and provided with the appropriate safeguards.
- h. All aircraft, equipment, work stands, solvents containers/buckets, people, and adjacent equipment shall be grounded prior to using the painting equipment.

- i. Prior to cleaning electrostatic paint guns, the operators shall ensure that they and the gun are grounded, and that the equipment is de-energized. All spray nozzles and auxiliary equipment being cleaned with flammable solvents shall be done inside the paint hangar facility with the ventilation system operating.
  - j. The manufacturers operational/safety procedural criteria is used as a supplement to these procedures.
  - k. All electrical equipment within the paint hangar facility must be approved for explosion proof environments. The painting equipment used for this process must have been tested and approved by a recognized laboratory for NFPA70 Class I, Division I, Groups C and D locations.
  - l. When painting fueled aircraft, the paint hangar facility and aircraft shall be protected with by a fire suppression system. The fire suppression system must be fully operational prior to the start of electrostatic painting. Facility fire suppression required for electrostatic painting is outlined in MIL-HDBK-1008, ETL 02-15, and ETL 98-8.
  - m. Supervisory personnel must ensure all fire/safety precautions have been implemented prior to the start of the painting operation.
  - n. LEL readings in the fuel vent areas must be taken prior to the painting of each aircraft. LEL readings must be maintained at or below 20 percent.
- d. All safety and regulating features on associated spray painting equipment and safety equipment shall be operational.
  - e. Unauthorized personnel will not be allowed in designated paint areas during painting operations.
  - f. Prior to starting a paint operation, ground all aircraft, metal solvent containers, flammable waste containers, airless and air-assisted airless paint spray equipment, and adjacent equipment as deemed necessary by the Base Safety Office.
  - g. Supervisory personnel must make sure all fire/safety precautions have been implemented prior to the start of the painting operations.
  - h. LEL readings at the fuel vent areas must be taken prior to the painting of each aircraft and maintained at or below 20 percent LEL.
  - i. Painting equipment shall be the HVLP or electrostatic type in accordance with EPA NESHAP requirements.

**5.5.3 Electrostatic Aircraft Painting.** Electrostatic painting of aircraft shall conform to the following safety and health protection precautions:



**5.5.2 Field Level Aircraft Painting Operations.** Field level painting of aircraft shall conform to the following safety and health protection precautions:



Electrostatic spray painting of JP-8 fueled aircraft constitutes a significant hazard when the on-board fuel temperature exceeds 100° F.

- a. Painting of aircraft at field level shall be limited to only maintenance painting operations. Maintenance painting is permitted in designated paint areas identified and approved per requirements in AFOSH STD 91-17 and approved by the Base Fire, Safety, Bioenvironmental, and Environmental Management Offices. Aircraft containing JP-5, JP-8, or equivalent fuel may be electrostatically painted at field level organizations, providing the on-board fuel temperature is below the flash point of 100° F before electrostatic painting operations begin.
  - b. The requirements for aircraft painting in AFOSH STD 91-17 shall be strictly followed.
  - c. Personnel involved in painting operations of both unfueled and fueled aircraft shall be trained in the fire/safety and environmental hazards associated with the processes.
- a. Aircraft to be electrostatically painted shall be defueled and purged. Exceptions: Aircraft fueled only with JP-5 and/or JP-8 are authorized to be painted with electrostatic airless spray equipment approved in SA 480 without being defueled and purged, providing fuel temperature remains below 100° F. Electrostatic spray painting of JP-5 or JP-8 fueled aircraft can only be performed in designated paint hangars that are approved for this function by the local base Fire, Safety, Bioenvironmental, and Environmental Management Offices. The aircraft being electrostatically painted must be grounded in two locations to prevent accidental electrical discharge from the electrostatic spray equipment. Each base is responsible for establishing procedures to ensure that the temperature of on-board fuel is below 100° F before and during electrostatic painting applications.
  - b. Electrostatic coating application equipment shall be used only in paint hangars or other areas designated and approved by the local base Fire, Safety, Bioenvironmental, and Environmental Office.
  - c. The ventilation system is on and operating and must also provide sufficient exhaust to remove the solvent vapors



generated by the process. The ventilation shall be sufficient to limit vapor concentration to 500 part per million or 20 percent of the LEL, whichever is lower. Electrostatic painting equipment powered by an external electrical source requires an interlock system to ensure that equipment can only be operated if the ventilation system is operational. An interlock system is not required for pneumatically operated equipment; however, the paint hangar facility shall be equipped with an audible alarm system which activates in the event of a ventilation system failure.

- d. All painters using the electrostatic equipment shall be trained in its use, the hazards associated with electrostatic painting, and the fire/safety problems associated with the process.
- e. All safety and regulating features on all equipment are operational.
- f. No unauthorized personnel are allowed in the paint hanger during electrostatic painting operations.
- g. Any personnel involved in concurrent operation in the paint hangar, not associated with the electrostatic painting process shall be briefed on the hazards of static on ungrounded objects and provided the appropriate safeguards.
- h. All aircraft, the electrostatic equipment, work stands, solvent containers/buckets, people, and adjacent equipment shall be grounded prior to using the electrostatic painting equipment.
- i. Prior to cleaning electrostatic paint guns, the operators shall ensure that they and the gun are grounded, and that the equipment is de-energized.
- j. The manufacturer's operational/safety procedures are used to supplement these procedures.
- k. All electrical equipment within the paint hangar facility must be approved for explosion-proof environments. The electrostatic painting equipment used for this process must have been tested and approved by a recognized laboratory for Class I, Division I, Groups C and D locations.
- l. When painting aircraft fueled with JP-5, and JP-8, the paint hangar facility and aircraft shall be protected by a fire suppression system. The fire suppression system must be fully operational prior to the start of electrostatic painting. Facility fire suppression required for electrostatic painting of fueled aircraft is outlined in MIL-HDBK-1008, ETL 02-15, and ETL 98-8.
- m. Supervisory personnel must ensure all fire/safety countermeasures have been implemented prior to the start of the painting operation.
- n. LEL readings in the fuel vent area must be taken prior to the painting of each aircraft. LEL readings must be maintained at or below 20 percent.

**5.5.4 Atmospheric Conditions For Painting.** Normally, coatings should not be applied under unfavorable atmospheric conditions such as high humidity, strong drafts or extremes of temperature. Painting should be accomplished whenever possible in an environmentally controlled facility capable of maintaining a range of 30 to 80 percent relative humidity and 60° F to 90° F. Some coatings may be applied outside these ranges without significant adverse effects, but paint personnel should always watch for adverse effects when applying paint outside of these ranges and develop painting decisions based upon local experiences for the particular types of coatings used and the local climate. Factors to be considered are:

**5.5.4.1** The temperature of surfaces being painted should be considered in any painting decision since it is a major factor in the drying or cure of coatings.

**5.5.4.2** Low humidity retards the cure of moisture curing coatings.

**5.5.4.3** High humidity can cause blushing of lacquers and also may result in condensation on the coating if the temperature of the coating drops to the dew point.

**5.5.4.4** Low temperatures cause slow drying, or cure, longer tack time, and sometimes incomplete cure. If the temperature is 50° F or lower, painting operations should be suspended.

**5.5.4.5** High temperatures cause too rapid an evaporation of solvent which leads to premature skinning, pinholes or solvent pop, blisters, cracked finish, or excessive dry spray. If the temperature exceeds 95° F, painting operations should be suspended.

**5.5.4.6** The aircraft skin temperature must be at least 60° F prior to any application of coatings. During extremely cold weather, this may require placing the aircraft in a heated paint facility several days in advance to ensure proper skin temperature.

**5.5.5 Test Panels.** To test suitability of materials, conditions, etc., spray test panels prior to beginning operations. The suitability shall be determined experimentally on a panel approximately 10 x 32 inches in size coated under prevailing conditions with the finish system that is to be applied. If the finish system applied to the experimental panel is satisfactory, then full scale operations may begin. Defects found in the experimental application such as blushing, poor adhesion, excessive orange peel, sagging, etc., shall be corrected prior to large scale application. Application of catalyzed (2-component) coatings having a long drying time usually cannot await inspection of completely cured and dry films, so use the best information available from the test panels at the beginning of the application. Test panels are not required for component/part or maintenance painting (touch-up).

**5.5.6 Material Requirements, General.** Materials used on Air Force aircraft and equipment should normally conform to Military or Federal Specifications and shall be applied as directed in this technical manual and other pertinent technical publications.

**NOTE**

Unauthorized material shall not be used by Air Force activities on aircraft and associated equipment.

**5.5.6.1** Proprietary non-specification materials may exist on aircraft and equipment as supplied by the manufacturer, and the maintenance of these may offer special difficulties. Normally, the repair and maintenance of proprietary coatings should be with the same material. However, if a material cited in this technical order is determined by the ALC corrosion manager or the weapon/item manager engineering function to be compatible with the proprietary coating, use the cited material for touch-up. In case of complete unit stripping and recoating, only Air Force authorized specification materials shall be used.

**NOTE**

Avoid the possibility of incompatibility of materials under the same specification but of different manufacture by not mixing them. Primers of different manufacture but under the same specification shall not to be mixed in the same area, but may be applied separately to areas which are to be overcoated. Every effort shall be made; however, to assure that an entire topcoat is restricted to the product of a single manufacturer and, where possible, to the same batch in order to maintain uniformity of color, gloss, etc.

**5.6 THE AIRCRAFT PAINTING PROCESS SEQUENCE OF EVENTS.**

- a. Clean and mask the aircraft per Chapter 3 of this technical order.

- b. Apply conversion coating to bare aluminum surfaces per Chapter 3 of this technical order.
- c. Allow at least 2 hours for the conversion coating to dry and set up. Then, move the aircraft (if required) to the paint hangar, with no delay in the outside environment.
- d. After the aircraft is situated in the paint facility, begin application of the primer after 2 hours minimum to 48 hours maximum has elapsed since applying the conversion coating to the aircraft.

**NOTE**

If the aircraft was not prepared in the paint hangar and was moved to the paint hangar the aircraft must be allowed to dry (if necessary) and the aircraft skin to warm to room temperature and solvent wipe the entire aircraft surface per Paragraph 3.1.4. of the technical order.

- e. Allow the primer to cure for the time specified in Chapter 3, but no more than 8 hours, and apply 2 coats of the required topcoat in the appropriate paint scheme per Chapter 8 of this manual, aircraft drawings, or -23 manual or equivalent manual. If more than 8 hours elapse (not to exceed 24 hours) between priming and topcoating, the primer must be solvent wiped for reactivation per Paragraph 3.1.6 or scuff sanded with 320 or 400 grit sandpaper or A-A-58054, Type I, Grade A, abrasive mat per Paragraph 3.1.3 to reactivate the primer for adhesion of the topcoat. If the primer is scuff sanded, solvent wipe per Paragraph 3.1.4 must be reaccomplished prior to topcoat application. If 24 hours elapse between priming and topcoating, solvent wipe only for reactivation is not permitted and scuff sanding is mandatory.

5.6.1 Aircraft Paint Application Sequence.**WARNING**

- Aircraft shall be primed and painted so painter's exposure to the spray mist or cloud is minimized.
- Always spray with painter's back or side upwind, and never direct spray upwind.
- Two or more painters spraying at the same time shall never spray directly at each other and shall be positioned as far apart as possible or on opposite sides of the aircraft.
- When priming, start at the end of the aircraft near the exhaust filter bank and move toward the air supply.

Application of coatings on aircraft by spraying methods is best accomplished by at least two painters supported by helpers to handle lines, stands, etc., as required. Four painters may be required on larger aircraft. Recommended painting sequences are as follows:

## 5.6.1.1 Small aircraft-tail toward hanger/insert exhaust.

## a. Priming

- (1) For "T" tail aircraft, apply a full wet coat of primer to the horizontal stabilizer upper surface starting at the center moving outboard to the tip with a stroke perpendicular to the leading edge. Using this same technique, prime the horizontal stabilizer lower surface and then apply a full wet coat of primer to the outboard edge of the tip and the front of the leading edge working from the tip to the junction with the vertical stabilizer. Apply a full wet coat of primer to each side of the vertical stabilizer(s) starting at the top and leading edge moving down and aft with a vertical stroke. Finally, apply a full wet coat of primer to the front of the vertical stabilizer(s) leading edge starting at the top moving down. For bottom mounted horizontal stabilizer aircraft prime using the same techniques as for a "T" tail aircraft except prime the vertical stabilizer first. Prime vertical stabilizer mounted engine nacelles using the same techniques at this time.
- (2) Apply a full wet coat of primer to the aft section of the fuselage starting at the aft end and the top moving forward and down to the junction with the wing trailing edge with a vertical stroke. Prime any aft fuselage mounted engine nacelles using the same techniques at this time.
- (3) Apply a full wet coat of primer to the lower surface of the wings starting at the tip moving inboard to the wing root with a stroke perpendicular to the leading

edge. Prime all wing mounted pylons, tanks, and nacelles, all main landing gear pods and doors, lower fuselage between the wings on low wing aircraft, the side of the fuselage beneath the wings, and the lower fuselage on high wing aircraft using the same techniques at this time.

- (4) Apply a full wet coat of primer to the upper surface of the wings starting at the tip moving inboard toward the fuselage with a stroke perpendicular to the leading edge. Apply a full wet coat of primer to the wing tip outboard edge and the front of the leading edge starting at the tip and moving inboard. For low wing aircraft, prime the fuselage side above the wing and the top of the fuselage using the same techniques at this time.
- (5) Apply a full wet coat of primer to the forward section of the fuselage starting at the wing leading edge and the top moving down and forward to the nose with a vertical stroke.

## b. Topcoating

- (1) Topcoats are applied in either a one coat or a two coat system. For a one coat system, apply a mist coat of the topcoat with a stroke in one direction followed immediately by a full wet crosscoat with a stroke perpendicular to the stroke of the mist coat working small areas at a time. For a two coat system, apply the first coat with a stroke in one direction and the second coat with a stroke perpendicular to the first coat, but after the first coat "time to overcoat" specified for the coating system has elapsed.
- (2) Apply topcoat to the fuselage forward section starting at the nose and leading edge with the initial stroke perpendicular to the fuselage length. Apply the criteria in Paragraph 5.6.1.1 step b (1).
- (3) Apply topcoat to the upper surface of the wings starting at the tip and moving inboard toward the fuselage with the initial stroke perpendicular to the leading edge. Apply the criteria in Paragraph 5.6.1.1 step b (1). For lower wing aircraft coat the fuselage section above the wings using the same technique at this time.
- (4) Apply topcoat to the lower surface of the wings starting at the tip moving inboard toward the fuselage with the initial stroke perpendicular to the leading edge. Apply the criteria in Paragraph 5.6.1.1 step b (1). Apply topcoat to all wing mounted pylons, tanks, and nacelles, all main landing gear pods and doors, lower fuselage between the wings on low wing aircraft, and the side of the fuselage on high wing aircraft using the same techniques at this time. Finally, apply topcoat to the outboard edge of the tip and front of the leading edge starting at the tip and moving inboard toward the fuselage.

- (5) Apply topcoat to the fuselage aft section starting at the wing trailing edge and the top moving aft and down to the aft end with the initial stroke perpendicular to the aircraft length. Apply the criteria in Paragraph 5.6.1.1 step b (1). Topcoat any aft fuselage mounted engine nacelles using the same techniques at this time.
- (6) Apply topcoat to the horizontal stabilizer upper surface on "T" tail aircraft starting at the center and moving toward the tip with the initial stroke perpendicular to the leading edge, and then topcoat the horizontal stabilizer lower surface starting at the tip moving inboard to the junction with the vertical stabilizer. Topcoat each side of the vertical stabilizer(s) on "T" tail aircraft next starting at the top and the leading edge moving down and aft to the junction with the fuselage with the initial stroke in a vertical direction. Topcoat the front of the leading edge of the vertical stabilizer(s) starting at the top moving downward. Topcoat any vertical stabilizer mounted engine nacelles using the same techniques at this time. Apply the criteria in Paragraph 5.6.1.1 step b (1). Bottom mounted horizontal stabilizer aircraft are topcoated using the same techniques except the vertical stabilizer(s) are topcoated first.

#### 5.6.1.2 Large aircraft-nose toward hanger exhaust.

- a. Priming. Apply primer using the same techniques as for small aircraft with tail toward the exhaust except reverse the order of areas being primed, i.e. prime from the nose working toward the tail.
- b. Topcoating. Apply topcoat using the same techniques as for small aircraft with tail toward the exhaust except reverse the order of areas being topcoated, i.e. topcoat from the tail working toward the nose.

5.6.1.3 Walkway Coatings. Specialty walkway coatings applied to the upper wing main gear pods, upper fuselage, and horizontal stabilizer: surfaces should be applied before topcoating the aircraft. Any masking for walkway areas should then be removed and the aircraft should then be topcoated while the walkway coating is curing. If any anti-slip grit is added to the topcoat material for application to

walkway areas, the above does not apply; and the walkway areas should be coated with topcoat material to which anti-slip grit is added as the second topcoat for these areas.

5.6.2 Overspraying Existing Coating Systems On Aircraft and Aerospace Equipment. It is always better to start a paint system from bare metal; however, it is feasible to overspray existing paint systems. For aircraft, this must be authorized by Chapter 8 of this manual or the weapon system specific technical orders.

#### NOTE

Adhesion failure between coatings requires complete removal of the nonadhering coating. When intercoat adhesion failure occurs over large areas, overcoating shall not be accomplished, and complete strip/repaint is required. Refer to Chapter 2 of this technical order for removal.

- a. Clean, mask, scuff sand, and vacuum surface to be overcoated per Paragraph 3.1.3 of this technical order.
- b. Apply conversion coating to repair bare aluminum surfaces per Chapter 3 of this technical order.
- c. Allow at least 2 hours for the conversion coating to dry and set up. Aircraft requiring movement to a paint hangar must be moved with minimal delay in the outside environment.
- d. After the aircraft or equipment is situated in the paint facility, or after 2 hours minimum has elapsed since applying the conversion coating to the aircraft, solvent wipe the entire aircraft surface per Paragraph 3.1.4 of this technical order.

#### NOTE

If the aircraft was not prepared in the paint hangar and was moved to the paint hangar after scuff sanding, the aircraft must be allowed to dry (if necessary) and the aircraft skin to warm to room temperature before final solvent wipe and before conversion coating application if not already done.



- e. Begin overcoating within 48 hours after scuff sanding and conversion coating operations and immediately after solvent wipe down. Apply one thin/mist coat of MIL-PRF-23377 Type I, Class C (one full wet coat per Table 5-2, to large bare metal areas) to the entire aircraft or equipment exterior painted surface per instructions in Paragraph 5.6. Allow 5 hours at 75° F for the primer to dry, but no more than 8 hours, and apply 2 coats of the required topcoat MIL-PRF-85285 and appropriate paint scheme per Chapter 8 of this manual, aircraft drawings, -23 manual, or equipment manual. If more than 8 hours elapse (not to exceed 24 hours) between priming and topcoat, the primer must be solvent wiped for reactivation per Paragraph 3.1.6 or scuff sanded with 320 or 400 grit sandpaper per Paragraph 3.1.3 to reactivate the primer for adhesion of the topcoat. If the primer is scuff sanded, solvent wipe per Paragraph 3.1.4 must be reaccomplished prior to topcoat application. If 24 hours elapses between priming and topcoating, solvent wipe for reactivation is not permitted and scuff sanding is mandatory.
- f. A non-chromated tiecoat/Primer (Class N) may be used for overcoating of existing coating systems after scuff sanding. This is an alternative to MIL-PRF-23377 Type I, Class C. All bare metal areas must have primer applied using MIL-PRF-23377 Type I Class C before application of the tiecoat. Allow 2 hours for the primer to dry, but not more than 8 hours prior to application of the tiecoat. Apply the tiecoat and topcoat per Paragraph 5.6.2 for MIL-PRF-23377 Type I, Class C and MIL-PRF-85285.

#### NOTE

These primers do not provide adequate corrosion protection and shall not be applied over bare metal areas.

**5.6.3 Curing of Finishes.** After painting, allow aircraft finish system to cure in a dust-free temperature controlled atmosphere for a sufficient time prior to placing in service. In the absence of accelerated curing, the aircraft shall not be flown for at least 72 hours after painting. In general, all painted aircraft should be handled, taxied, etc., as little as possible during the first week after painting.

**5.6.4 Coating Thickness Measurements.** Wet and dry film gauges are available as local purchase items from various laboratory supply houses. If paint film thickness measuring instruments are not available, small (2 x 6 inches) anodized aluminum panels will be used for measurement of the paint thickness after drying. Apply these panels to each side of the fuselage with a section of one inch wide masking tape

doubled back on itself with adhesive contacting the panel and the aircraft surface prior to the painting operation. Mask one end of the panel with tape for a distance of approximately 2 inches to provide a comparison of the original panel thickness and the thickness after painting. Remove the panel after application of the primer so that immediate maintenance painting can be used to cover those areas previously protected by the panel. This procedure will also permit locating other panels on various portions of the same aircraft to provide a good indication of the overall paint thickness. The location of panels depends upon inspection procedures and may vary throughout the aircraft. Each aircraft should use a set of panels for each different operation employed on the aircraft identified by the name of the painter, aircraft model, and the date of painting, to provide follow-on data during any subsequent service evaluation. Slight errors in paint thickness measurements can be expected when using this method due to thickness tolerances for the basic aluminum sheet. Measure the paint thickness with an ordinary micrometer possessing flat contact surfaces. Micrometers with pointed or rounded contact surfaces are not recommended. At least 6 readings shall be taken on both painted and unpainted portions of each panel to provide an average paint thickness measurement. When using a wet film gauge or an Electronic Dry Film Gauge, a minimum of 6 readings shall also be taken. Take readings in a 1 square foot area that is representative of the entire area being painted. Rejection is only if the average of the 6 readings falls outside of the thickness range for that particular paint system.

**5.6.5 Allowable Coating Thickness.** Because of the greatly reduced corrosion protection for a dried film thickness of less than 0.3 mils (0.0003 inch), solitary primer films below this thickness shall be avoided. Attaining proper coating thickness by spraying is a matter of technique plus checking. There is a limit to the thickness that can be applied in one pass because of protracted drying time or possible sagging of the film. This must be considered in obtaining the total desired thickness. Also, there is a tendency with coating materials of good hiding power to increase the spreading rate as the work progresses and this must be curbed. Operator fatigue may alter the speed of working, but this should not be allowed to result in applying more or less material to the surface. Changing atmospheric conditions during operations may have to be compensated for in order to continue applying a uniform film. Frequent checks with a wet film thickness gauge shall be made during painting to ascertain and control film thickness. Thickness cannot be gaged accurately without instruments, but lacking these, the best assurance of consistent films is in correct adjustment of the gun for the material being applied and the use of good judgement. See Table 5-2 for dry film thickness ranges of various primers and topcoats.

**Table 5-2. Allowable Coating Thickness for Production Level Finishing (Depot, Original Manufacture, Field)**

Coating Specification	Number of Coats	Dry Film	
		Thickness Range (inches) <sup>(1)</sup>	
		Minimum <sup>(2)</sup>	Maximum <sup>(2)</sup>
MIL-PRF-23377 and MIL-PRF-85582 Epoxy Primers	One coat	0.0006	0.0018
	To Be Reactivated <sup>(3)</sup>	0.0004	0.0013
	Mist, "Light Dust Coat" Activation	0.0002	0.0005
	After Reactivation, Total	0.0006	0.0018
TT-P-2760 Elastomeric Polyurethane Primer	Two coats	0.0008	0.0020
	One coat	0.0010	0.0015
MIL-PRF-85285 High Solids Polyurethane Coating	Two coats	0.0012	0.0025
	One coat (without cross coat)	0.0016	0.0032
	One or two coats (with cross coat)	0.0016	0.0050
MIL-PRF-22750 Topcoat	Three to four coats <sup>(4)</sup>	0.0048	0.0070
	One coat	0.0008	0.0020
MIL-C-27725/SAE AMS-C-27725 Fuel Tank Coating	Two coats	0.0016	0.0040
	Two coats	0.0008	0.0012

- (1) In most cases the desired coating thickness should be the low to nominal for the range specified unless there is a requirement for thicker coatings. The higher end of the range is not intended to be the mean or average of thickness measurements (unless it is required) but to allow for overlaps, etc., that occur in localized areas or sections of a part or surface. Measurements should not be taken around edges or holes and considerations must be allowed where overlap occurs such as in angles and on irregular surfaces.
- (2) Lower end of thickness range is expected when painting detail parts and small assemblies. Mid to high end of thickness range is often needed when finishing large areas such as the exterior of aircraft.
- (3) A single coat which is to be reactivated with a "light dust coat" before topcoat application after scuff sanding.
- (4) This coating thickness is intended for use only in specific areas where wear or abrasion are a factor, such as leading edges. These unique requirements should be specified in finish documents.

**5.6.6 Inspection Control.** Inspection shall enforce the requirements of this technical manual.

- a. Proper and adequate equipment shall be used at all times.
- b. Materials shall be thoroughly mixed with thinners and catalysts properly proportioned.
- c. Ensure that thorough cleaning and proper preparations are taken prior to application of each coat, proper drying times are observed before recoating, and coatings are applied at the proper thickness.
- d. Ensure the general appearance, texture, color, and gloss are acceptable. No sand paper finish to exceed approximately 320 grit coarseness, wrinkling, crazing, blistering, fisheye, lifting, or pitting/cupping as defined in this technical order is permissible. To exceed limits of Paragraph 5.6.6.2.6.

**5.6.6.1** Certain physical tests shall be made before, during, or after coating operations:

- 5.6.6.1.1 Water Break Test (refer to Paragraph 3.1.9).
- 5.6.6.1.2 Spray Test Panel (refer to Paragraph 5.5.4).
- 5.6.6.1.3 Coating Thickness Measurement (refer to Paragraph 5.6.2).
- 5.6.6.1.4 Adhesion (Wet) Tape Test. This method covers a procedure suitable for establishing acceptability of intercoat and total surface adhesion of an organic coating system.
  - 5.6.6.1.4.1 Adhesion tests shall be made on the completed exterior finish system after drying for a period of at least 48 hours in a sufficient number of selected areas to ensure a satisfactory level of adhesion for the overall finish system.
  - 5.6.6.1.4.2 To perform this test, wet a piece of cloth/gauze pad with either tap or distilled water and cover with plastic



sheet taped on the area under inspection. The test area shall be soaked for a 24 hours minimum, and shall have a minimum diameter of 3 inches.

5.6.6.1.4.3 Remove the wet cloth and plastic sheet and blot up the surface water. Immediately apply a 1 inch strip of tape, PN 250, manufactured by 3M Company, (NSN 7510-00-283-0612), age of tape not to exceed 3 years, adhesive side down. Press the tape down, using two passes of a 4 1/2 pound rubber covered roller or employ firm pressure with the hand.

**NOTE**

This tape is the only approved tape (no alternatives or substitutes).

5.6.6.1.4.4 Remove the tape in one abrupt motion, and examine the test area for any paint damage such as removal of one of the layers of the finish system or removal of the entire system from metal. Any removal constitutes failure of the wet tape test.

5.6.6.1.4.5 Gloss shall be measured in accordance with the general procedures described in Federal Test Method Standard 141, Method 6101 and 6103, except that the measurements will be made on flat or approximately flat surfaces of the aircraft instead of a test panel. The test shall be made on the complete exterior finish after drying for a period of at least 24 hours in a sufficient number of areas to assure that the required gloss has been obtained. See Table 5-3.

**Table 5-3. Gloss Requirements**

Gloss Meter Degrees	Paint System Reading	Unit
60	Semi-gloss	35-45
60	High-gloss	90 Min
60	Gloss	80 Min
60	Camouflage	7 Max
60 and 85* (both)	Gunship*	3 Max

\* Both Meters Required

5.6.6.2 Evaluation and classification of discrepancies for complete aircraft painting.

5.6.6.2.1 The paint system, pattern, and markings shall be in accordance with weapon system specific TO's, aircraft drawings, or other applicable directives, and Chapter 8 of this manual.

5.6.6.2.2 Colors of camouflage pattern shall fade and blend into each other with irregular lines of demarcation, with no straight or sharp lines.

5.6.6.2.3 No color variation in any single color area of the camouflage pattern or paint scheme when the surface is viewed with the unaided eye from a distance of 50 feet is allowed. Touch-up of the paint system to correct minor discrepancies by the paint activity will produce some minor color variation and is acceptable.

5.6.6.2.4 No more than 2 minor sags or runs per 50 square feet of surface is allowed (a minor run is one which does not exceed two inches in length).

**NOTE**

Slight orange peel appearance is inherent with the PR-1434 GV polysulfide primer/MIL-PRF-85285, Type I polyurethane paint system and is acceptable.

5.6.6.2.5 The paint system shall pass the paint adhesion wet tape test. Candidate test areas shall include the following (where applicable): Upper center wing, left and right upper inboard and outboard wing, left and right lower wing surface (inboard and outboard), left and right horizontal stabilizer surface (upper and lower), left or right side of vertical stabilizer, cargo door, MLG pod, engine pylon, engine nacelle, left and right side of fuselage forward and aft, lower fuselage or belly (multiple sites shall be selected for this area). Failure of this test includes peeling of topcoat to primer as well as primer to bare metal.

5.6.6.2.6 Fifteen or more individual discrepancies, any combination of discrepancies with a total area of 15 or more square feet, or any one discrepancy with an area of 5 or more square feet wrinkling, crazing, blistering, lifting, or pitting/cupping as defined in this technical order or peeling of topcoat to primer or primer to bare metal shall be reported as a major defect. List all these discrepancies by number found and type, area of each, and total area of all discrepancies.

**NOTE**

Failure of 25 percent of the wet tape adhesion tests prescribed here shall be reported as major defect. List all failures of this test by location on the aircraft.

5.6.6.3 Frequency of Inspection. The quality control plan and frequency of inspection shall be decided by local quality control authority. For large surface painting (e.g., the partial or complete repaint of an aircraft), a predetermined number of tests may be applied to sampled areas of each item. For subassembly and component painting, inspection of paint shop workmanship may be covered by in-process inspection or inspections of representative samples items according to a sampling plan either on a time basis or production count basis. Testing shall be kept to the minimum necessary to determine acceptability of the finished work. System and Item Managers have the option to specify a frequency of test in technical orders or work specifications on their equipment.

**5.6.7 Soil Barrier Coating.** If approved by weapon system technical order, this coating may be applied to all newly painted aircraft in the jet engine exhaust, APU exhaust, and gun/rocket blast exhaust areas to protect the newly painted surfaces. If left unprotected, the above areas will be very difficult to clean after exposure to the aforementioned exhausts. This material and application procedures are called out in TO 1-1-691. If used, the soil barrier coating shall be applied after the topcoat cures at least 24 hours and prior to engine run-up.

## **5.7 INTERIOR FINISHING PROCEDURES AND OPERATIONS.**

**5.7.1 Preparation For Coating.** Cleaning and anodizing (new parts) or chemical surface treatment of metals and metal parts per Chapter 3 is a necessary prerequisite on all interior surfaces prior to priming and painting operations.

**5.7.2 Coating Application.** Where wash primer per MIL-C-8514 or DOD-P-15328 is required for interior surfaces, follow with TT-P-1757, Type II, Class C both applied in the same manner and with the same precautions and restrictions prescribed for external finishing in this technical order. Other interior surfaces, where wash primer is not a specific requirement, shall be finished with MIL-PRF-23377 Type I, Class C epoxy primer applied directly on treated metal. Interior surfaces painted with TT-P-1757 may be touched up using TT-P-1757 or MIL-PRF-85582 Type I, Class C. The MIL-PRF-85582 Type I, Class C waterborne epoxy primer shall be used to touch-up areas where TT-P-1757 alkyd primer is present, as solvents in MIL-PRF-23377 may cause the TT-P-1757 to soften and flake off. If appearance is of concern, either epoxy primer may be topcoated. Primer application shall be in conformance with this section. For areas specified to be a particular color, Sherwin Williams DTM Gloss Latex Enamel, or MIL-PRF-85285 Type I polyurethane, shall be applied over the primer in the desired color and in the same manner and with the same precautions and restrictions as are prescribed for exterior finishing in this technical order. For aircraft subject to spillage or leakage of diester oil or diester grease, the MIL-PRF-23377, Type I, Class C/MIL-PRF-85285, Type I system is mandatory on the interior surfaces subject to this contamination such as the wheel wells and their doors, speed brakes, engine access doors, and main landing gear doors, in the color specified in the technical data. The interior colors prescribed by Specification MIL-C-8779 shall be applied in the locations called out in that specification, the aircraft drawings, or the aircraft -23 manual.

**5.7.3 Refinishing of Fiber Glass Components.** Proceed as follows.

- a. Remove the topcoat per Chapter 2.
- b. Thoroughly solvent clean per Chapter 3.

c. On the epoxy-primed surface:

- (1) Sand the surface with 280 grit abrasive paper and solvent clean. Do not sand through the primer.
- (2) Reactivate the surface per Chapter 3.
- (3) Apply 1 coat of MIL-PRF-23377 Type I, Class C epoxy primer.
- (4) Apply 2 coats of MIL-PRF-85285, Type I polyurethane topcoat.

## **5.8 MAINTENANCE PAINTING.**

Closely inspect candidate areas for extent of damage and maintenance painting required. If inspection reveals major paint failure or damage, such as chipped or peeled paint from the center of a skin panel, the involved skin section should be prepared and maintenance painted from seam to seam. If only minor damage is found, i.e., paint chipped or missing from screw/rivet heads and on outer edges of skin panel(s) the specific area may be prepared and maintenance painted. Prepare damaged area(s) and paint as follows:

### **5.8.1 Epoxy or Polyurethane Primer/Polyurethane Topcoat.** Proceed as follows.

- a. Thoroughly clean area to be repainted.
- b. Feather edges of coating adjacent to peeled section and scuff sand the other area(s) to be coated per Chapter 3. Use 180 grit paper or nylon abrasive matting material A-A-58054, Type I, Grade A or B, very fine or fine for scuff sanding. Grit size down to 120 may be used as long as care is taken not to score the metal surfaces.
- c. Wipe scuffed or sanded areas with approved solvent per Paragraph 3.1.4. Repair damaged conversion coatings per Paragraph 3.1.9, Paragraph 3.1.14 or Paragraph 3.1.18 step a.

### **5.8.2 Primer and Polyurethane Touch Up.**

#### **5.8.2.1 Brush or Spray.** Proceed as follows:

- a. Apply (brush or spray) one thin coat of epoxy primer Specification MIL-PRF-23377 Type I, Class C, MIL-PRF-85582 Type I, Class C, or Polyurethane Primer TT-P-2760 Type I, Class C, to area being touched up. Thoroughly mix the primer materials per instructions in Chapter 6 before use, but the viscosity need not be checked.
- b. Apply one full wet coat of MIL-PRF-85285, Type I polyurethane topcoat in the required color. If required, apply a second coat after allowing 1-4 hours curing period for the first coat.

5.8.2.2 Touch-up Pen. Proceed as follows:

- a. Touch-up using MIL-PRF-23377 Type I, Class C or MIL-PRF-85582 Type I, Class C epoxy primer and MIL-PRF-85285 Type I high solids polyurethane in the touch up applicator pen. These self contained touch up applicators are available by national stock number under the coating specification.

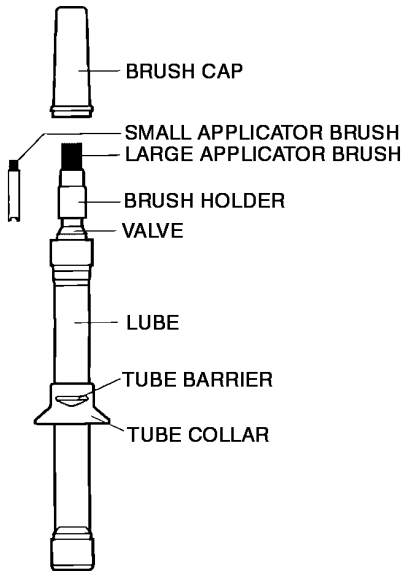

FO9603-23

**Figure 5-1. Sempen**

- b. The applicator provides two-component pre-measured materials which are separated by a barrier, Figure 5-1. To mix the materials for use, displace the barrier separating the materials by sliding the tube collar all the way to the back of the applicator, Figure 5-2. Shake the applicator vigorously by hand until the materials are thoroughly mixed (approximately one minute).

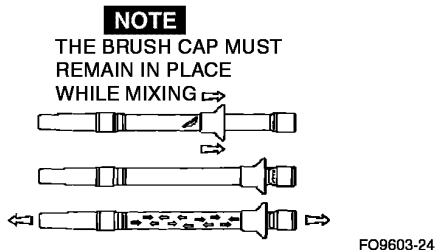

**Figure 5-2. Sempen Mixing**

**NOTE**

The brush cap must remain in place while mixing.

**CAUTION**

After mixing, remove the brush cap and press the applicator against a test article to bleed off any internal pressure that may have formed during storage.

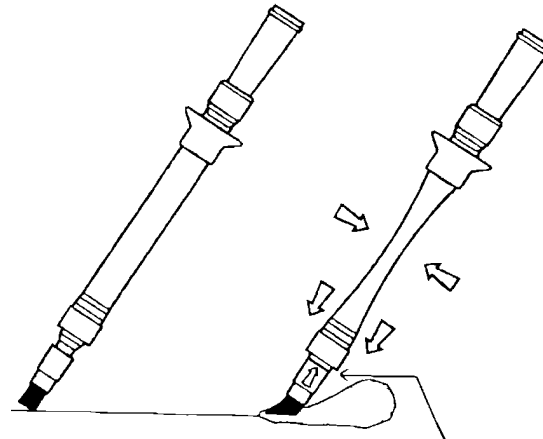

NEVER OPEN THE SPRING-LOADED VALVE AS SHOWN UNLESS MATERIALS HAVE BEEN MIXED.

FO9603-25

**Figure 5-3. Sempen Application**

- c. Apply the primer by pressing the applicator brush against the work surface. This opens the spring-loaded valve which allows the coating material to flow when the tube is gently squeezed, Figure 5-3. Use the brush to distribute primer onto the work surface as required. Replace the brush cap when the applicator is not being used.
- d. Apply one full wet coat of MIL-PRF-85285, Type I mixed polyurethane topcoat with a touch-up pen in the same manner. If required, apply a second coat after allowing 1-4 hours curing period for the first coat.

5.8.3 Aerosol Touchup.

- a. Power Pak Spray Unit NSN 4940-00-803-6444, Specification MIL-S-22805/SAE-AS-22805, Type I, Class 134A (PN M22805-1-134A) may be valuable aid in accomplishing field maintenance painting. (See Figure 5-4). The kit is designed to be disposable and intended for use in isolated areas when air spray guns cannot be used or are not available. Replacement propellant HFC/Type R134A propellant cans may be obtained under A-A-58060, Type R134A, (PN AA58060-R134AW034).
- b. Preval Spray Unit, 8020-01-501-3127, (Preval Sprayer Kit with Power Unit and Glass Bottle), or 8020-01-496-

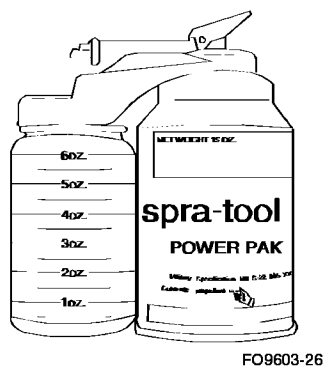

**Figure 5-4. Spray Tool**

2473, (Preval Power Unit Only). Each power unit is capable of spraying up to 16 oz. of liquid.

#### 5.8.4 Brush/Roller Touchup.

##### **NOTE**

Aerosol spraying is limited in application and shall be held to a minimum. Using only approved coatings, it is permitted for touch-up of scratches, etc., and areas not exceeding one-half square foot in area.

5.8.4.1 Paint brushes and rollers can be used effectively for touch-up and maintenance painting, but they will not produce the esthetic results of a spray application. Some advantages of brush and roller touch-up over spray application are:

5.8.4.2 Masking is minimized, and in most cases, is not required at all.

5.8.4.3 More economical for small area and low volume painting because much less paint is required.

5.8.4.4 More efficient for application of stencil type markings and grit containing anti-slip walkway coatings.

5.8.4.5 Requirements for solvent thinners is very limited.

5.8.4.6 Coating transfer efficiency is almost 100% with no over spray and very little air pollution that is generated by a small amount of solvent evaporation.

5.8.4.7 Hazardous and non-hazardous waste is minimized and limited to used brushes or roller covers and small amounts of excess primer or paint.

5.8.4.8 Can be performed in standard maintenance facilities without specialized ventilation and air filtering while other maintenance is being performed.

5.8.4.9 PPE is limited to chemical type gloves and eye protection (face shield or chemical type goggles).

5.8.5 Brush Application. It is very difficult to get a smooth professional appearance without brush strokes with the brush touch-up method on metal surfaces. Therefore, brush touch-up should be limited to areas of one square foot or less and preferably to areas of one square inch or less such as fastener heads. Use a fine, flat nylon or nylon/polyester blend bristle brush with a chiseled tip or a triangular tip foam brush having a width appropriate for the job at hand. The application procedure is as follows:

- a. Scuff-sand and solvent wipe the touch-up area per Chapter 3.
- b. Mix and thin the primer or paint for brush application per Chapter 6 and the manufacturer's instructions. Mix the least amount possible for the job at hand.

##### **NOTE**

Pint quantities are more economical than quart or larger quantities to avoid waste of the unused portions when doing small touch-up jobs.

- c. Dip the brush to 1/2 its bristle length into the paint or primer and no more. Remove the brush, and press it lightly against the inside of the container to distribute the liquid throughout the thickness of the brush and eliminate any excess. Do not drag the brush over the container rim as this will form bubbles in liquid in the container.
- d. Grasp the brush at the bottom of the handle as if holding a pencil at a 60° angle to the surface. Start the brush stroke on one side of the touch-up area with light pressure in the "feathered" paint area, heavier pressure in the bare area, and light pressure again in the opposite "feathered" paint area.
- e. If the area is completely covered, blend the paint into all the "feathered" edges using just the brush tip stroked at several different angles across the initial stroke; and proceed to the next area.
- f. If the area is not completely covered, begin the next stroke parallel to the first stroke with an over lap of about 1/4 of the brush width using the same pressure methods as in step (4) and replenishing the paint or primer on the brush per step (3) as needed. When the entire area is covered blend the paint or primer as in step (5).
- g. If primer was applied, allow the proper cure time; then apply the topcoat using the same brush techniques as in steps (1) through (6).



**5.8.6 Roller Application.** While not as good as sprayers for metal surfaces, rollers do provide a smoother and more professional appearance than brushes. Therefore, rollers may be used to touch-up large areas. The most effective roller covers for application of primer are manufactured from ultra-high density sponge. The most effective roller covers for topcoat are manufactured from lint-free, extra-density, high-quality soft-woven fabric, with a maximum nap length of ¼ inch. The core roller center should be resistant to water and solvent. Choose a handle of the proper length and a roller of the right width (3 to 9 inches) for the job at hand, and use one with a splatter shield to prevent the coating from splattering on personnel and other surfaces not being coated. For large areas, power or automatic feed rollers are more efficient and their use eliminates the possibility of spillage from open containers. To minimize spillage when using manual rollers, use coating container grids. Move the roller across the grid to eliminate excess coating material. Polyurethanes and epoxy coatings require a little more paint on the roller during application to achieve a smooth surface and a second cross-coat may be required. The application procedure is as follows:

- a. Scuff-sand and solvent wipe the touch-up area per Chapter 3.
- b. Mix and thin the primer or paint for roller application per Chapter 6 and the manufacturer's instructions. Mix the least amount possible for the job at hand. Insert the vertical, portable, metal grid into the container; or pour the liquid into the power/automatic feed roller reservoir.
- c. Dip the roller fully into the primer or paint. Withdraw the roller, and move the roller across the vertical metal grid to distribute the liquid throughout the roller pile and eliminate any excess. For power or automatic feed rollers, depress the feed trigger until the roller is full of liquid; and move the roller across a vertical, portable metal grid mounted in an empty container after the initial filling only to distribute the liquid throughout the pile evenly.
- d. Always start application in a corner of the area being touched-up. The maximum area of coverage should be about 9 square feet before moving to an adjacent area. Place the free end of the roller about 3 feet away from where the roller stroke will end so that it covers a small portion of the left or right "feathered" edge of the area being touched-up completely and with the roller at an angle to this edge. For horizontal surfaces, always make the first stroke away from you; and without lifting the roller from the surface, make alternate strokes toward and away from you to form a "W" pattern. For vertical surfaces, always make the first stroke upward; and without lifting the roller from the surface, make alternate up and down strokes to form an "M" pattern. Fill in the gaps in the "W" or "M" patterns with crisscrossing strokes of the roller moving back across the "W" or "M" pattern and still not lifting the roller from the surface. Make sure that the entire section is completely covered, including its "feathered" edges, before moving to an adjacent section or finishing the touch-up of an area less

than 9 square feet. Always use even pressure on the roller to prevent bubbles and blotches in the primer or paint.

- e. If the touch-up area is not entirely covered, touch-up a section adjacent to the first section making sure it overlaps the first section about 2 inches. Application is by the same techniques as in step (4).
- f. If primer was applied; allow the proper cure time, and then apply the topcoat using the same roller techniques as in steps (1) through (5).

**5.8.6.1** Based on the final report for a Roller Application of Aerospace Coatings project that is posted on the AFCPCO web site, the following general vendor information is supplied for rollers tested during the project that were capable of applying aerospace coatings within the film thickness ranges listed in this manual. Commercial and NSN info will be posted on the AFCPCO web site as it becomes available.

**5.8.6.2** Primer application rollers can be purchased commercially from any vendor who handles the Whizz-Roller System, "premium sponge" product line.

**5.8.6.3** Topcoat application rollers can be purchased commercially from any Sherwin-Williams distributor/supplier handling the "contractor series" soft-woven roller ¼ inch nap line of products.

#### NOTE

Other similar or equivalent rollers are authorized.

**5.8.7 Temporary Protection.** When polyurethane is not available, repair of paint systems with MIL-DTL-85054, Type I or II, CPC sprayed on or brushed on bare metal areas for protection until polyurethane is available is permissible. (See TO 1-1-691) Complete painting of aircraft with other than polyurethane MIL-PRF-85285, Type I, is not authorized.

**5.8.8 Powder Coating.** New support equipment is being delivered coated with thermoplastic or thermoset powder coatings. Thermoplastic powder coatings are generally applied to a surface that has been preheated to a temperature significantly higher than melting point of the powder, whereas thermoset powders contain a heat-activated catalyst and are generally applied to a surface at ambient temperature. The surface and the powder are then heated and as the temperature rises past the melt temperature of the powder, it melts to the surface.

**5.8.8.1 Surface Preparation.** In situations where complete removal of the thermoplastic/thermoset powder coatings are required, they shall be stripped with PMB, Type II or Type V, using procedures listed in Paragraph 2.11. Chemical paint removal procedures listed in this TO are very ineffective at removing these coating and, therefore, should not be used.

5.8.8.2 Maintenance Painting. Maintenance painting of thermoplastic/thermoset powder coatings shall be accomplished using epoxy or polyurethane topcoat procedures listed in Paragraph 5.8.





## CHAPTER 6

# USAF STANDARD COATING SYSTEMS FOR AIRCRAFT AND EQUIPMENT

### 6.1 CLASSIFICATION OF ORGANIC COATINGS.

Customarily, finishing materials are classed as paints, enamels, lacquers, and special coatings such as epoxies and polyurethanes. The word "paint" is loosely used to mean all finishing materials. Modern coatings now include quite different components in combinations that do not fall into the old categories. Coating materials used by the Air Force are generally identified by the basic classifications above. General information on materials in these categories used by the Air Force is presented here.

#### NOTE

- National Stock Numbers (NSNs) for specific coatings and related materials are to be obtained from FSC (normally FSC 8000). Also, see the current GSA Catalog and the DO43 System to convert specification and part numbers to NSNs.
- To determine the proper paint system for specific equipment, refer to -23 TO's, and aircraft paint drawings, for aircraft; TO 35-1-3 for support equipment; or specific repair TO's.

### 6.2 CONSTITUENTS OF ORGANIC COATINGS.

Modern paints may be a mixture of many things, but the primary constituents are pigment, vehicle (the film former) and solvents. Secondary components (although they may still be of prime importance) may be extenders, driers, antioxidants, surfactants, light-filtering agents, and/or other additives. When special properties are required such as luminescence, fluorescence, fire retardant, etc., materials to provide these are also added.

### 6.3 PIGMENTS.

Pigments are finely divided, substantially insoluble, and usually opaque materials incorporated into paints to provide color, hiding power, and specific qualities such as light and heat reflectance (or heat absorption), corrosion-inhibition, and certain flow characteristics. Pigments may be inorganic or organic types and of either natural or synthetic origin. Examples are the metallic compounds such as zinc oxide and titanium dioxide in white and light tinted paints, zinc chromate in primers to give yellow coloration and act as a corrosion inhibitor, chromium oxide for green, iron oxide for red, etc. Synthetic agents or dyes are also widely used. A limited number of pigments are used as corrosion inhibitors in protective primers. The particular pigment used depends

upon the metal that is to be protected, steel, aluminum, magnesium, etc., and the environment to which it is to be subjected.

#### NOTE

The theoretical function of a protective paint is to physically exclude environment from the metal surface; but, practically, it rarely succeeds entirely. All organic films are moisture permeable to some degree. Also, tiny physical defects in a film are usually present to some degree or develop in time. General practice is to supplement the physical protective properties of coatings with materials that provide electrochemical protection either by using surface conversion coating treatments (refer to Chapter 3) or wash primers, or by inclusion of corrosion-inhibiting pigments in the primer coatings.

### 6.4 VEHICLE.

The vehicle is the liquid portion of the coating. It is the most significant part of the coating as it furnishes desired qualities of adhesion, toughness, flexibility and resistance to various environments. The vehicle consists of non-volatile and volatile portions. The non-volatile includes resins, drying oils and plasticizers that become the binding agent in the cured film. Upon evaporation of the volatile portion, the non-volatiles form the actual film on the surface together with the pigment, if one is present. Vehicles appear in a multitude of combinations, containing many materials. A varnish vehicle in enamels generally contains an oil-modified alkyd resin, thinners and driers. A lacquer vehicle consists mainly of resins, solvents and plasticizers.

### 6.5 PREPARATION OF COATING MATERIALS FOR USE, GENERAL.

#### WARNING

Containers of paint may develop internal pressure during storage and should be opened with caution.

Coating materials shall be prepared for application under clean conditions with clean equipment. Paint shops shall be equipped with mechanical paint agitators of suitable capacity. The proper sequence for preparing packaged materials prior to each use is as follows:

- a. Allow materials to come to room temperature.
- b. Remove lids and inspect paint for skin-over, gelling, lumps, etc. Skins, if present, shall be carefully removed and discarded, retaining liquids which drain from them. Gelled, lumpy, or otherwise deteriorated paints shall not be used.

**NOTE**

Cans of pigmented paint with non-resealable lids should not be opened and inspected until after the original mechanical agitation.

- c. Thoroughly agitate all pigmented paints, using a mechanical agitator prior to thinning and prior to and during application.
- d. Thinning shall be controlled by weight, volume, or viscosity measurement to obtain and maintain proper and uniform consistency. Thin according to manufacturer's instructions or the specification for the material. When the volatile organic compound (VOC) content of coatings is regulated, thin only with exempt thinner or solvent, and do not use non-VOC compliant thinners or solvents such as MIL-T-81772 to reduce high solids primers and topcoats. Reducing with non-VOC compliant thinners or solvents can cause high solids coatings to exceed the maximum allowable VOC content in violation of air pollution regulations.
- e. Reduction and/or catalyzation of coatings shall be in accordance with Paragraph 6.6, Paragraph 6.7, and the specific coating paragraph as well as the manufacturer's instructions. If this does not produce the proper spraying viscosity, quality control personnel shall be consulted.
- f. Strain all material to be used in spray equipment through fine-mesh strainers or cheesecloth.

**6.6 MIXING AND THINNING OF COATING MATERIALS, GENERAL.**

**WARNING**

Mixing shall be done in controlled areas that are well ventilated and away from any open flame or other source of ignition and direct sunlight. Forced air ventilation, preferable with air flow from the back of personnel to an exhaust in front of them. For two component materials, an organic vapor type respirator shall be worn as a minimum, with the air supplied type being preferable.

Mixing of coating materials may seem too elementary to require lengthy discussion, but it is a very common source of trouble either through negligence or lack of knowledge. All coating materials require preparation prior to application, and

problems with color, gloss, hiding power, film application characteristics, adhesion, and curing can be expected if materials are not adequately prepared. For two-component materials, the components must be thoroughly mixed with each other and in the exact specified proportions or curing and adhesion problems will occur. Pigments, which give color and other desirable characteristics to coatings, are generally insoluble and heavier than the liquid portion of the coating material, so they eventually settle out of suspension. The consistency or viscosity of the liquid portion determines the rate of settling; for example, pigments mixed with a thinner alone would settle out in a few minutes; but in a paint vehicle, it might take months. The practice of thinning too much material at a time and pouring unused portions of the material back into the original container with unthinned material lowers the total consistency and increases the rate of settling and should not be done. Settled material usually re-disperses readily unless the material is over-aged or has become exposed to the atmosphere. In some materials, such as wash primers and some vinyl based materials, settling may be accompanied by a change in chemical structure after storage of only a few months. Such changes are not reversible; therefore, judgment should be employed whenever using them.

**NOTE**

After a coating materials shelf life has expired, thoroughly test material per Appendix A before using it. If an aged material appears unsuitable after appropriate attempts at mixing and reducing, it should be discarded. If the quantity involved is large, laboratory tests by Robins Science and Engineering Laboratory to determine its continued conformance to specification requirements will be required before its use or its disposal.

**6.6.1 Method of Mixing.** Mixing in containers shall be done per the following methods:

- a. Hand-mixing of single-component materials and the catalyst component of two-component materials in cans and drums, per the manufacturer's instructions using wooden or plastic paddles.
- b. Mixing of one-component materials and the base component only of two-component materials in containers up to five gallons is best accomplished by using mechanical shakers that vibrate or shake the unopened container.
- c. Accomplish mixing of one-component materials and the base and catalyst components of two-component materials with low speed mechanical paddles.

**6.6.2 Mixing Test.** A simple test of complete mixing is to flow samples down an inclined piece of glass. Irregularities

of color or flow will indicate incomplete mixing. Comparison of materials from the bottom and top of a container may be made by this method.

## 6.7 SOLVENTS, DILUENTS AND THINNERS.

At ordinary room temperatures, the consistency or viscosity of mixtures of oils, pigments, and resins that make up coating materials is too high to allow spreading them effectively over surfaces in the desired thickness. Also, most resins are solids and need to be dissolved in a liquid before they can be dispersed. A solvent has the essential function of reducing the viscosity of the vehicle portion of the material to the point where it can be managed. Solvents do not react chemically with coating constituents or dissolve pigments; and ultimately, they are lost from the coating by evaporation having served their purpose. Most solvents are organic materials and are classified by their chemical structure as alcohols, esters, ketones, etc. In practice, they must be considered from the standpoint of their powers of solvency as expressed in reference to some material. A liquid may dissolve one substance well, another poorly, and still others not at all. There is no universal solvent in coating technology. A liquid that does not actually dissolve a given substance may, however, be used as a diluent or a thinner for that substance. Solvents and diluents are frequently used together in coating formulations, and the purpose of a liquid determines whether it is "solvent" or "diluent". For example, mineral spirits is a solvent for linseed oil, but not for cellulose nitrate. But solutions of cellulose nitrate in butyl acetate will tolerate substantial amounts of mineral spirits and here the mineral spirits is used as a diluent for the solution. Diluents and thinners are normally less expensive than solvents. Generally, the solvent portion of a coating is itself a blend of solvents, each one chosen for its power to dissolve a particular

constituent of the coating, and each present in proper proportion to regulate evaporation to a rate that prevents premature segregation of any single dissolved constituent.

### NOTE

- Although in practice the terms solvent, diluent, and thinner are often used interchangeably to describe a liquid, it should be understood that, the words have different meanings; and the mechanism of solvents and diluents or thinners are different. For example, a solvent will thin incidentally while performing its prime purpose of dissolving something; whereas a diluent or thinner is used to reduce viscosity and/or regulate evaporation and is not required to, and may be unable to, dissolve any constituents of the coating concerned. Of course, thinner must be compatible with the coating. Compatibility is beyond determination in the field; hence, only authorized thinners specifically called out for use with a given coating shall be used to thin it.
- To distinguish between "diluent" and "thinner", the material added by the manufacturer to adjust viscosity is called a "diluent", while the same material added by the painter for the same purpose is called "thinner".

6.7.1 Volatility. Volatility is the rate at which a solvent evaporates, governs the length of time a paint film remains fluid. Thus, it affects performance characteristics of the paint film when deposited, such as smoothness of flow-out, time an edge remains wet to enable blending of overlapped strokes of

the spray gun or brush, tendency to sag or run, drying time, etc. Volatility also largely governs the flash point of materials.

6.7.2 Thinners.

**WARNING**

The very properties that make a substance a good solvent for organic materials tend to make it harmful to the body. Many are also hazardous due to flammability. Use caution to avoid unnecessary and continued exposure to the volatile constituents of paints either by inhalation or by skin contact. Precautions must be taken at all times to prevent accidental ignition.

Thinner is the material added to a coating material by the painter to adjust its viscosity. The following specification thinners are among those used in Air Force painting:

6.7.2.1 A-A-3007, is thinner for enamels such as TT-E-489, for spray applications.

6.7.2.2 MIL-T-81772 Aircraft Coating Thinner covers three types of thinners for reducing the standard aircraft coatings. They are suited for, but are not necessarily limited to, the following applications:

6.7.2.2.1 Type I is for thinning, MIL-PRF-85285 and MIL-C-83231/SAE AMS-C-83231 polyurethane coatings, or other coatings as authorized.

6.7.2.2.2 Type II is for thinning, MIL-PRF-23377 epoxy primer, MIL-PRF-22750 epoxy coating, or other coatings as authorized.

6.7.2.2.3 Type III is for thinning, TT-P-1757 primer, or other coatings as authorized.

6.7.2.3 Special purpose “thinners” are often added to coating materials to provide good drying characteristics under abnormal environmental conditions. High boiling point solvents such as diacetone alcohol (ASTM D2627) and butyl alcohol (ASTM D304) are often added to prevent blushing.



FO9603-27

**Figure 6-1. Zahn Cup**

6.7.3 Viscosity. Viscosity is a measure of a liquid’s resistance to flow. Very viscous or thick liquids such as molasses flow very slowly, while low viscosity liquids such as water flow very quickly. Maintaining the proper viscosity is very important for proper spray application of primers and paint coatings. Too high a viscosity produces poor spray patterns and poor coverage, while too low a viscosity produces a film that sags and runs easily. Many different methods can be used to measure viscosity, but the easiest and most frequently used methods for primers and paint coatings are flow time measurements from either a No. 2 Zahn Cup or a No. 4 Ford Cup. Therefore, the acceptable viscosity ranges for each primer and paint coating discussed in this technical order are given in flow time in No. 2 Zahn Cup and No. 4 Ford Cup seconds at 75° F. For any of these materials, the viscosity will be somewhat higher at lower temperatures and somewhat lower at higher temperatures. Viscosity is measured as follows:

6.7.3.1 No. 2 Zahn Cup. (See Figure 6-1) After the primer or paint coating is properly mixed, fully immerse the cup in the liquid so it is completely filled, and lift the cup out of the liquid. Using a stop watch, measure the time in seconds it takes the material to flow out of the hole in the bottom of

the cup from the moment the cup clears the liquid surface to the point where the first break in the flow stream is noted. This time is the viscosity in No. 2 Zahn seconds.

#### NOTE

The No. 2 Zahn Cup doesn't work well for high-solids coatings. The No. 4 Ford Cup is preferable for these high-Solids coatings.

**6.7.3.2 No. 4 Ford Cup.** After the primer or paint coating is properly mixed, pour the material into the cup mounted in a stand while blocking the hole in the bottom of the cup with a finger. Make sure the cup is completely filled, and then scrape away any excess sliding a flat glass plate across the rim of the cup. Leave the glass plate in place, and remove the finger blocking the hole in the bottom of the cup. Slide the plate horizontally to remove it from the top of the cup. Using a stop watch, measure the time in seconds it takes the material to flow out of the hole in the bottom of the cup from the moment the plate is removed to the point where the first break in the flow stream is noted. This time is the viscosity in No. 4 Ford Cup seconds.

**6.7.3.3 Adjustments.** If the viscosity measured is not within the specified range, thin the material per the thinning instructions for the primer or paint coating listed in this technical order, and remeasure the viscosity after cleaning the cup with thinner. Repeat as necessary until the viscosity is within the specified range.

#### 6.8 BLUSHING.

Blushing of coatings is the result of moisture condensation from the atmosphere within or on a drying organic film. It occurs when the temperature of the work surface and/or the coating material itself falls below the prevailing dew-point. Always look for it in production coating operations whenever high humidity conditions exist. It shows as a lighter-than-normal or whitish discoloration or increased opaqueness of film. It may occur to the extent that a surface powder results which can be removed by a fingernail or by light rubbing. (Rubbing will not cure the condition.) It may also be almost imperceptible, and blush-inducing conditions may escape notice on test panels sprayed prior to production coating due to their temperature differing from that of the actual work surface. Blushing most often occurs with quick-drying coatings such as lacquers and only rarely with enamels. It is detrimental in some degree to any coating material and will affect adhesion of any overcoat. Any blushed areas must be stripped and redone. Superficial blushing may occur at borderline temperature and humidity conditions and subsequently disappear. This is not considered harmful, and may be ignored.

#### NOTE

Slight blushing may sometimes be detected by noting faint dissimilarities of appearance in the film occurring over structural members underlying the surface such as bulkheads, ribs, etc. Skin surfaces in contact with internal structures may be lower in temperature than the surrounding skin, and this may be reflected and outlined in blushing.

#### 6.9 RESINS.

Natural resins are solid organic substances of vegetable or animal origin. Synthetic resins are man-made substances physically similar to natural resins. Rosin and shellac are examples of natural resins. Synthetic resins have largely taken over in modern coating formulations, because they can be made to order to furnish desired characteristics. Coating materials described in this technical manual are almost exclusively based on synthetics. The following are examples of resins and their special characteristics:

**6.9.1 Alkyds.** Alkyds are the backbone of modern enamel in a great many combinations. Federal Specification TT-E-489, is alkyd or modified alkyd enamel used by the Air Force. Alkyd is characterized by toughness, flexibility and durability, and is used in exterior and interior coatings for utility and decorative purposes. It does not have good chemical resistance.

**6.9.2 Acrylics.** Acrylics have outstanding light resistance and outdoor weather durability, with moderate chemical resistance. Used with nitrocellulose as a hardener, they have better drying properties and increased hardness.

**6.9.3 Vinyls.** Vinyls have limited aircraft application, but where construction materials, such as metal and wood must be protected from high humidity, acidic or caustic environments, vinyls are used. An example is Specification MIL-P-15930 vinyl-zinc chromate primer.

**6.9.4 Phenolics.** Phenolic resins are used in varnishes and enamels requiring extra hardness and abrasion resistance. Specification A-A-1800 spar varnish is an example.

**6.9.5 Silicones.** Silicone resins are used primarily in heat resistant coatings. They are not particularly hard surfaced and may craze. They are usually baked to cure.

**6.9.6 Epoxies.** Epoxies have outstanding adhesion and chemical resistance. In combination with other resins, they become baking enamels. For air drying types, catalysts are



mixed with a base material prior to application, starting a chemical reaction that continues after application to develop a film with good performance characteristics. The Air Force uses Specification MIL-PRF-23377 and MIL-PRF-85582 primers.

**6.9.7 Polyurethane.** Polyurethane resins are also catalyzed coatings. The Air Force MIL-PRF-85285 polyurethane coating, is characterized by its very high gloss retention in gloss finishes and its flatness in camouflage finishes, its superior toughness and outdoor durability, and good chemical resistance.

**6.10 ADHESION.**

Good adhesion of organic coatings requires a surface that is mechanically and chemically clean. A smooth or highly polished surface will have very poor coating adhesion and should be roughened to provide “tooth” for physical bonding. Adhesion to smooth materials such as glass is difficult and surface etching is essential. With plastics etching may be augmented by solvent activation to obtain some degree of fusion with the surface. Metal surfaces require an appropriate surface preparation such as conversion coating for adequate primer adhesion.

**6.11 PRIMERS.**

Primers are used to provide an adherent coating to which subsequent coatings will firmly adhere and to provide corrosion protection for metals. The pigment portion of primers for ferrous base metals usually consists of iron oxide, strontium chromate, zinc chromate, zinc oxide, zinc dust, or a mixture of these. Zinc or strontium chromate is the principal pigment in primers used on aluminum, magnesium, and their alloys. Primers are satisfactory for corrosion protection of metals, but are generally not suitable as topcoats. Color, weathering properties or physical durability may be unsatisfactory; and for these reasons, primers require protection by topcoating.

**6.12 COATINGS AND COATING SYSTEMS.**

Some examples of specification coatings are as follows:

**NOTE**

Because of the large number of Military and Federal Specifications approved for Air Force use, no attempt has been made to discuss all of them in this technical manual. In addition, many items of Air Force equipment and components are coated with proprietary materials making logistic support of such equipment difficult. Every effort should be made by responsible personnel to select standard Air Force approved specification material for overcoating or replacing these proprietary materials.

**6.12.1 USAF Standard Polyurethane Aircraft Coating System.** (See Chapter 8, aircraft -23 or other weapon system specific TO’s, and paint drawings for schemes, colors, and markings.) Optional standard polyurethane coating systems consist of epoxy primer MIL-PRF-23377, water reducible epoxy primer MIL-PRF-85582, polyurethane primer TT-P-2760, or polysulfide primer PR-1432GV, topcoated with high solids polyurethane coating MIL-PRF-85285, Type I. Additionally, a light dust coat may be utilized for the reapplication of MIL-PRF-85285, Type I over an existing coating. Most coatings formulated for these specifications are two-component materials intended for spray application.

**NOTE**

- Before applying a material, spray it on an aluminum panel to determine its suitability. Observe the panel for blushing, sagging, or other defects detectable during or shortly after application. Correct the cause of any defect found before continuing. This test panel is in addition to the one coated simultaneously with the aircraft and used as a check of the completed job.
- Epoxyies and polyurethanes cure (chemically react) rather than dry by evaporation. Use only clean equipment for mixing and applying the system to prevent contamination of the materials. Clean the equipment immediately after use with a suitable solvent before the coatings set up.
- Cure accelerators are not authorized for use in painting aircraft exterior surfaces as they make coatings brittle.
- Inadequate mixing or mixing in the wrong proportions causes poor adhesion, slow or incomplete curing, and poor performance of the coating.

**6.12.2 Primer Coating, Epoxy, For Aircraft Application, Specification MIL-PRF-23377.**

**6.12.2.1 Characteristics.** This is a two-component, low VOC, solvent-borne, lead free corrosion inhibiting epoxy primer particularly formulated for its adhesion properties. It is compliant with the NESHAP VOC requirements of 340 g/l (2.8 lbs/gal). It is very resistant to chemicals, lubricants, and corrosive atmospheres; but it has only fair weathering characteristics. Because it is an epoxy, this primer is difficult to remove with standard paint removers. This primer is available in two different types each with two different classes.

Type I	Standard pigments (yellow).
Type II	Low infrared reflective pigments (dark green).

Class C	Strontium chromate based corrosion inhibitors.
Class N	Non-chromate based corrosion inhibitors.



Class N shall not be substituted for Class C, unless authorization is given by the engineering authority for the system or item on which the primer is used.

**6.12.2.2 Uses.** A primer for MIL-PRF-85285 polyurethane topcoat for the exterior of aircraft, components, and other aerospace equipment, and as a stand alone primer on interior surfaces of aircraft and components.

**6.12.2.3 Mixing.** Thoroughly agitate components (Epoxy Resin Base Component A and Polyamide and/or amine resin curing agent Component B) preferably with a mechanical shaker prior to mixing and if required pour into separate measuring or metering containers. Using manufacturer's directions, mix proper volumes of the components A and B by pouring B into A and thoroughly agitating. Best mixing results can be achieved with a mechanical shaker. Mix only materials from the same manufacturer, and do not mix more material than can be used in a 4-hour period. After mixing, allow the primer to stand 30 minutes before applying. This primer must be agitated continuously during spraying applications to prevent settlement of pigment and ensure uniformity of color. If in-line or in-head proportioning equipment is used to mix base and catalyst (curing agent) as the paint is being used, a 30-minute dwell time is not required before application.

**6.12.2.4 Thinning.**



- MIL-T-81772 is flammable and moderately toxic to eyes, skin, and respiratory tract. Eye and skin protection required.
- Parachlorobenzotrifluoride (PCBTF), NSN 6850-01-399-0676, is combustible and an irritant to eyes, skin, and respiratory tract. Eye and skin protection required. Disposable 8 mil nitrile gloves, splash goggles, tyvek/cloth coveralls are the recommended PPE. Use in well ventilated areas.



In areas where air quality regulations restrict volatile emissions, do not add thinner MIL-T-81772 to the primer coating as that addition may raise the VOC content to greater than 340 g/L (2.8 lbs/gal).

#### NOTE

PCBTF, NSN 6850-01-399-0676, is exempt as a VOC or HAP by the EPA and by 48 states and will not change compliance of high solids coatings to air quality regulations.

The viscosity of the unthinned primer may range up to a maximum of 40 seconds in a No. 4 Ford Cup (56 seconds in a No. 2 Zahn Cup). Strain the primer through clean cheesecloth, per CCC-C-440, Type I, Class 2 or a commercial paint strainer. When required, adjust the viscosity by thinning to a viscosity of 8 to 19 seconds in a No. 4 Ford Cup (17 to 23 seconds in a No. 2 Zahn Cup). Use thinner per MIL-T-81772 Type II or PCBTF, NSN 6850-01-399-0676. Add MIL-T-81772, Type II thinner as required to achieve the viscosity range above. In areas where air quality regulations restrict volatile emissions, thin with PCBTF using up to 10% by volume as a recommended maximum for reduction of viscosity.

**6.12.2.5 Application.** Apply one coat of primer to a dry film thickness of 0.6 to 1.8 mils, per Table 5-2 (0.9 to 2.6 mils wet film). Allow a minimum of five hours air dry at 75° F and ten hours at 60° F before application of topcoat. After 8 hours at 75° F, solvent wipe per Chapter 3 to reactivate before topcoating. Since this epoxy primer has a very high solids content, cross coating may not be required; and the spray gun must be kept moving to prevent excessive film build-up with subsequent reduction of adhesion. Apply a topcoat within 24 hours of primer application. After 24 hours, scuff sand the entire primed surface with A-A-58054, Type I, Grade A abrasive mat and solvent wipe the area per Chapter 3 prior to topcoating. Discard any of this primer mixed for longer than the four hours pot life at 75° F. Higher or lower temperatures shorten or lengthen the pot life proportionally.

**6.12.2.6 Drying Time.** The times given here are for 75° F at 50% relative humidity. Lower temperatures and higher relative humidity will increase these drying times while higher temperatures and lower relative humidity will decrease these drying times. Tack free - 5 hours; Dry hard - 8 hours; Full cure - 48 hours.

6.12.3 Primer Coating, Epoxy, VOC Complaint, Chemical and Solvent Resistant, MIL-PRF-85582.

6.12.3.1 Characteristics. This is a two-component, lead free, water-reducible corrosion inhibiting, epoxy primer formulated to meet most local environmental pollution regulations. This primer is available in two different types each with three different classes.

Type I	Standard pigments (yellow).
Type II	Low infrared reflective pigments (dark green).
Class C1	Barium chromate based corrosion inhibitors.
Class N	Non-chromate based corrosion inhibitors.



Class N shall not be substituted for Class C1 or Class C2, unless authorization is given by the procuring activity or engineering authority for the system or item on which the primer is used.

6.12.3.2 Uses. As a primer for MIL-PRF-85285 polyurethane topcoat for aircraft and a stand alone primer on interior surfaces of aircraft and components.

6.12.3.3 Mixing. See manufacturer's mixing instructions, as different manufacturers may have different mixing ratios and methods.

6.12.3.4 Thinning. Thin with water per the manufacturer's instructions as each manufacturer may have different thinning ratios and methods. Application viscosity will be approximately 14 seconds in a No. 4 Ford Cup (20 seconds in a No. 2 Zahn Cup). Allow the mixed and thinned primer to stand 30 minutes prior to use.

**NOTE**

The volume of some primers may increase by 250% when properly thinned with water.

6.12.3.5 Application. After thoroughly cleaning, surface treating, and solvent wiping the surface to be primed per Chapter 3 and purging spraying equipment lines with a mixture of 25% TT-I-735 isopropanol alcohol and 75% water, apply the primer to a dry film thickness of 0.6 to 1.8 mils; see Table 5-2 (2.5 to 3.8 mils wet film). Allow a minimum of two hours air dry at 75° F or higher and 50% or less relative humidity and four hours at lower temperatures and high humidity to a maximum of eight hours before topcoating. After eight hours, the primer shall be lightly scuff-sanded with A-A-58054, Type I, Grade A abrasive mat, tack-ragged and solvent wiped before topcoat application. Areas that are not clean will not support the primer film, which will break

into droplets; like a water break test. If this happens, the primer can be blotted up, the area wiped clean with a clean cloth dampened with solvent per Table 3-2, and the primer reapplied.

6.12.3.6 Drying Time. The times given here are for 75° F at 50% relative humidity. Lower temperatures and higher relative humidity will increase these drying times while higher temperatures and lower relative humidity will decrease these drying times. Tack free - 1 hour; Dry hard - 6 hours; Full cure - 48 hours.

6.12.4 Primer Coating, Polyurethane, TT-P-2760.

**WARNING**

TT-P-2760 is moderately toxic to eyes, skin, and respiratory tract. Eye and skin protection required. Consult Bioenvironmental Engineering to determine need for respiratory and ventilation requirements.

6.12.4.1 Characteristics. This is a two component, low VOC, solvent borne, highly flexible elastomeric polyurethane primer. The maximum VOC content of the primer coating is 340 g/L (2.8 lbs/gal). It is available in two different types each with two different classes.

Type I	Standard pigments (yellow or light brown).
Type II	Low infrared reflective pigments (dark green).
Class C	Strontium chromate based corrosion inhibitors.
Class N	Non-chromate based corrosion inhibitors.

**NOTE**

Class N shall not be substituted for Class C unless authorization is given by the procuring activity or engineering authority for the system or item on which the primer is used.

6.12.4.2 Uses. As a primer for MIL-PRF-85285 polyurethane topcoat. It is a suitable alternate for MIL-PRF-23377 and MIL-PRF-85582 primers and can be used as a touch-up primer for both MIL-PRF-23377 and MIL-PRF-85582 on exterior surfaces. Because of this primer's flexibility, it is recommended for high impact areas such as leading edge slats, and the entire exterior surface on large, flexible cargo and bomber aircraft.

6.12.4.3 Mixing. Shake the base material (component A) for five minutes on a paint shaker and stir the catalyst (component B) with a wooden paddle prior to mixing. Pour one volume of catalyst into one volume of base, and mix the

material thoroughly following manufacturer's instructions. Do not mix more material than can be used in four hours.

#### NOTE

Some materials are mixed in a three to one by volume ratio.

#### 6.12.4.4 Thinning.

#### WARNING

- MIL-T-81772 is flammable and moderately toxic to eyes, skin, and respiratory tract. Eye and skin protection required.
- PCBTF, NSN 6850-01-399-0676, is combustible and an irritant to eyes, skin, and respiratory tract. Eye and skin protection required. Disposable 8 mil nitrile gloves, splash goggles, tyvek/cloth coveralls are the recommended PPE. Use in well ventilated areas.

#### CAUTION

- All thinners used with this coating must be "urethane grade" with a water content of less than 0.05% by weight.
- In areas where air quality regulations restrict volatile emissions, do not add thinner MIL-T-81772 to the primer coating as that addition may raise the VOC content to greater than 340 g/L (2.8 lbs/gal).

#### NOTE

PCBTF, NSN 6850-01-399-0676, is exempt as a VOC or HAP by the EPA and by 48 states and will not change compliance of high solids coatings to air quality regulations.

Thinning of this primer is not required, as viscosity as manufactured should be correct for spray application. If thinning is done, it shall be with MIL-T-81772, Type I or PCBTF, NSN 6850-01-399-0676. Use thinner in the least quantity necessary to get the proper viscosity. The application viscosity will be approximately 14 seconds in a No. 4 Ford Cup (20 seconds in a No. 2 Zahn Cup).

**6.12.4.5 Application.** After thoroughly cleaning, surface treating and solvent cleaning the surface to be primed per Chapter 3, apply one coat of primer to a dry film thickness of 1.0 to 1.5 mils (1.7 to 2.5 mils wet film) per Table 5-2. This primer will not adhere to an improperly prepared or contaminated surface. Allow a minimum of two hours air dry at 75°

F and 50% relative humidity or four hours at 60° F and 50% relative humidity before application of topcoat. The coating must be applied in a relative humidity range of 30% to 80%. If humidity is below 30%, add moisture to the air by wetting the floor of the painting area or by equivalent methods. After 8 hours at 75° F, solvent wipe per Chapter 3 to reactivate before topcoating. If the primer is not topcoated within 24 hours, reactivate the primer surface by light sanding or scuffing with A-A-58054, Type I, Grade A abrasive mat and solvent wiping per Chapter 3. Discard any primer mixed longer than four hours.

**6.12.4.6 Drying Time.** The times given here are for 75° F at 50% relative humidity. Lower temperatures and higher relative humidity will increase these drying times while higher temperatures and lower relative humidity will decrease these drying times. Tack free - 5 hours; Dry hard - 8 hours; Full cure - 48 hours.

#### 6.12.5 Primer Coating, Elastomeric, Polysulfide Corrosion Inhibiting, PR-1432GV.

#### WARNING

PR-1432GV is moderately toxic to eyes, skin, and respiratory tract. Eye and skin protection required. Consult Bioenvironmental Engineering to determine need for respiratory and ventilation requirements.

**6.12.5.1 Characteristics.** This is a two component, polysulfide primer, particularly formulated for its corrosion resistance and flexibility. It is a superior material for protection of relatively flexible aircraft structures as it does not crack or peel away from fasteners in highly stressed areas, and it will not crack, peel, or rupture from lap and butt joints. The physical properties of this primer on large flexible aircraft structures will increase the longevity of the paint system as well as decrease maintenance and corrosion rework during the life cycle of the coating system.

**6.12.5.2 Uses.** As a primer for MIL-PRF-85285 polyurethane topcoat on aircraft exterior surfaces. The Weapon System Manager shall specify when this primer is to be used.

**6.12.5.3 Mixing.** Adequate curing of sealant and sealant based coatings depend on proper and controlled component mixing by weight. This ensures that the component ratio is as close as possible to that specified by the manufacture. When mixing partial kits, an accurate scale is required that will weigh up to 2.6 kilograms to the nearest 0.1 of a gram. One scale meeting these requirements is the Triple Beam 760-W Balance made by Paul N. Gardner Co., Inc.; 316 N.E. First St.; Pompano Beach FL 33060. Mix the base compound and (component A) and the accelerator (component B) in the



## TO 1-1-8

proportions of 15 to one by weight. Always properly mix in the correct proportions by the manufacturer's directions for optimum results.

### NOTE

The base compound has a tendency to settle out in storage and should be thoroughly mixed prior to adding the accelerator.

- a. Shake the base compound on a standard paint shaker for five minutes.
- b. Mix the accelerator by stirring with a paddle and add to the base compound.
- c. Replace the base compound container lid and shake for two to three minutes in an upright position followed by two to three minutes in an inverted position.

### NOTE

Fast and longer mixing decreases application time (pot life). High humidity (70% R.H. or above) at time of mixing decreases application time (pot life).

**6.12.5.4 Thinning.** As supplied, this material is too viscous to be easily sprayed and must be thinned prior to application. Thinning of the material shall be accomplished immediately after mixing of the two components. Transfer the mixed material to a pressure pot, thin 50% by volume with a ASTM D740 MEK and A-A-59107 Toluene blend, and mix in the pressure pot for 2 minutes at 70 RPM. Use the MEK/Toluene blend specified below for the following mixing and application temperatures. After thinning, the viscosity of the material shall be 8 to 22 seconds in a No. 4 Ford Cup (17-29 seconds in a No. 2 Zahn Cup).

75° F - 50% (by volume) MEK and 50% (by volume) Toluene.

85° F - 25% (by volume) MEK and 75% (by volume) Toluene.

65° F - 75% (by volume) MEK and 25% (by volume) Toluene.

**6.12.5.5 Application.** The primer can be applied by HVLP, airless spray, or air assisted airless spray. The primer has a 2-hour pot life at 75° F temperature and 50% relative humidity. For every 18° F rise in temperature, the application time (pot-life) is reduced by half; and for every 18° F drop in temperature, the application time is doubled. The polysulfide primer shall be applied to a wet film thickness of 3.0 to 4.0 mils which results in a dry thickness of 1.0 to 1.2 mils. The polyurethane topcoat, MIL-PRF-85285, Type I can be applied anytime after the polysulfide primer is tack free up to 24 hours if no moisture or dirt is on the aircraft, the aircraft is

kept in an environmentally controlled hangar, and no maintenance or walking has been done on the aircraft.

**6.12.5.6 Drying Time.** At 75° F, the tack free time is approximately 6 hours, 3 hours at 90° F, and 12 hours at 60° F; however, high humidity at time of application will shorten the tack free time.

### NOTE

- The material shall be applied to test panels as specified in Paragraph 5.5.5, so that any defects can be corrected prior to production spray application. The correct line and pot pressure can be determined at this time.
- Some orange peel appearance in the coating system is inherent with this primer and is acceptable.
- It is mandatory that spray equipment be cleaned immediately after use.

**6.12.6 Tiecoat, Non-Chromated.** This coating differs from MIL-PRF-23377 which has requirements directed toward the corrosion protection of and adhesion to bare metal. The tiecoat purchase description requirements are only for adhesion to other coatings. Tiecoats listed here meet all of the requirements for MIL-PRF-23377 Type I, Class N, except for the corrosion protection requirements and are an interim authorization until completion of the purchase description. All test results and certifications for meeting the MIL-PRF-23377 Type I, Class N, with the exception of the corrosion protection requirements must be submitted to AFRL/MLS-OLR for inclusion in this technical order. The following coatings are approved as tiecoats for overcoating existing MIL-PRF-85285 paint systems:

8010-01-482-8620 Aeroglaze 9741 (light gray) U/I GL

8010-01-483-4363 Aeroglaze 9743 (red) U/I GL

8010-01-483-4365 Aeroglaze 9744 (dark gray) I/I GL

EEAE 136

Spraylat Corp.

1701 East 122nd Street

Chicago, IL 60633

02-R-008 (Red)

Deft Chemical Coatings

02-W-38 (White)

17451 Von Karman

Irvine, CA 92614

**6.12.6.1 Characteristics.** This is a two-component, VOC, solvent-borne, lead and chromate free epoxy coating particularly formulated for its adhesion properties to other coatings. It is compliant with the NESHAP VOC requirements of 340 g/l (2.8 lbs/gal). It is very resistant to chemicals

and lubricants; but it has only fair weathering characteristics. Because it is an epoxy, this coating is difficult to remove with standard paint removers.

**6.12.6.2 Uses.** As a tiecoat over existing coating systems for the reapplication of MIL-PRF-85285 polyurethane topcoat on the exterior of painted aircraft and other aerospace equipment.

**6.12.6.3 Mixing.** Thoroughly agitate components (Epoxy Resin Base Component A and Polyamide or amine resin curing agent Component B) preferably with a mechanical shaker prior to mixing. If required pour into separate measuring or metering containers. Using manufacturer's directions, mix equal volumes of the components A and B by pouring B into A and thoroughly agitating. Best mixing results can be achieved with a mechanical shaker. Mix only materials from the same manufacturer, and do not mix more material than can be used in a 4-hour period. After mixing, allow the primer to stand 30 minutes before applying. This primer must be agitated continuously during spraying applications to prevent settlement of pigment and ensure uniformity of color. If in-line or in-head proportioning equipment is used to mix base and catalyst (curing agent) as the paint is being used, a 30 minute dwell time is not required before application.

**6.12.6.4 Thinning.**

#### WARNING

- MIL-T-81772 is flammable and moderately toxic to eyes, skin, and respiratory tract. Eye and skin protection required.
- PCBTF, NSN 6850-01-399-0676, is combustible and an irritant to eyes, skin, and respiratory tract. Eye and skin protection required. Disposable 8 mil nitrile gloves, splash goggles, tyvek/cloth coveralls are the recommended PPE. Use in well ventilated areas.

#### CAUTION

In areas where air quality regulations restrict volatile emissions, do not add thinner MIL-T-81772 to the primer coating as that addition may raise the VOC content to greater than 340 g/L (2.8 lbs/gal).

#### NOTE

PCBTF, NSN 6850-01-399-0676 is exempt as a VOC or HAP by the EPA and by 48 states and will not change compliance of high solids coatings to air quality regulations.

The viscosity of the unthinned tiecoat may range up to a maximum of 40 seconds in a No. 4 Ford Cup (56 seconds in a No. 2 Zahn Cup). Strain the tiecoat through clean cheesecloth, per CCC-C-440, Type I, Class 2 or a commercial paint strainer; and when required, adjust the viscosity by thinning to a viscosity of 8 to 19 seconds in a No. 4 Ford Cup (17 to 23 seconds in a No. 2 Zahn Cup). Use thinner per MIL-T-81772 Type II or PCBTF (NSN 6850-01-399-0676) Add MIL-T- 81772, Type II thinner as required to achieve the viscosity range above. In areas where air quality regulations restrict volatile emissions, thin with PCTBF using up to 10% by volume as a recommended maximum for reduction of viscosity.

**6.12.6.5 Application.** Apply one coat of tiecoat to a dry film thickness of 0.6 to 1.8 mils, (0.9 to 2.6 mils wet film). Allow a minimum of five hours air dry at 75° F and ten hours at 60° F before application of topcoat. After 8 hours at 75° F, solvent wipe per Chapter 3 to reactivate before topcoating. Since this epoxy tiecoat has a very high solids content, cross coating may not be required; and the spray gun must be kept moving to prevent excessive film build-up with subsequent reduction of adhesion. Apply a topcoat within 24 hours of primer application. After 24 hours, scuff sand the entire primed surface with A-A-58054, Type I, Grade A abrasive mat and solvent wipe the area per Chapter 3 prior to topcoating. Discard any of this tiecoat mixed for longer than the four hours pot life at 75° F. Higher or lower temperatures shorten or lengthen the pot life proportionally.

**6.12.6.6 Drying Time.** The times given here are for 75° F at 50% relative humidity. Lower temperatures and higher relative humidity will increase these drying times while higher temperatures and lower relative humidity will decrease these drying times. Tack free - 5 hours; Dry hard - 8 hours; Full cure - 48 hours.

**6.12.7 Polyurethane Topcoat, High Solids (MIL-PRF-85285, Type I).**

**6.12.7.1 Characteristics.** This coating is a two-component high solids, polyurethane coating formulated for compliance with air quality regulations with a 420 g/1 (3.5 lbs/gal) VOC content.

**6.12.7.2 Uses.** Type I is intended for use on aerospace weapons systems and other applications. Type II is intended for use on ground support equipment and shall not be used on aircraft due to its very low flexibility.

**6.12.7.3 Advanced Performance Coating (APC),** qualified to MIL-PRF-85285, Type I, also known as Extended Life Topcoat (ELT) is a chemically cured two component polyurethane topcoat formulated with fluorinated polyol resin to provide a protective coating with exterior durability and cleaning efficiencies superior to conventional MIL-PRF-85285 polyurethane coating. APC, when used over MIL-PRF-23377 or MIL-PRF-85582 epoxy primer, provides fade



resistance superior to conventional polyurethane topcoats. Although some degradation in fade resistance will occur if APC is applied over PR-1422GV elastomeric polysulfide primer, color retention still exceeds MIL-PRF-85285 requirements.

#### 6.12.7.4 Mixing.

### WARNING

- The catalyst portion of polyurethane topcoat contains a resin that may contain up to one percent Hexamethylene Diisocyanate (HDI). This material is a sensitizing agent and in low atmospheric concentrations is a strong respiratory and skin irritant. After the catalyst portion containing HDI is mixed with the polyester resin base component, the HDI reacts chemically with the resin base and the potential for generation of HDI is significantly reduced. Personnel mixing the isocyanate catalyst component with the polyester resin base component must avoid the vapors and skin contact of these materials. Mixing shall be done in exhaust ventilated booth or well ventilated area.
- Personnel shall wear plastic or rubber gloves, plastic apron, and a face shield. Requirement for respiratory protection during mixture and application procedures shall be determined by Bioenvironmental Engineering.
- Even after the polyurethane components have been mixed as noted below, painting with the polyurethane paint, Specification MIL-PRF-85285 still may result in a significant health hazard to the painter. Respiratory protection shall be specified by the local medical service based upon the process evaluation by Bioenvironmental Engineering. Also, it is important that all the precautions required for spray painting as outlined in AFOSH STD 91-17 be rigidly enforced. Personnel with histories of allergies or asthma shall be cleared through the base medical services before using any material containing diisocyanates.

### CAUTION

Since the polyurethane is sensitive to moisture, ketones, and alcohols, use only clean, dry equipment for mixing and keep the mixed material in closed containers. Use adequate oil and water separators between the air supply and pressure pot to exclude water. Water reacts with the catalyst and liberates carbon dioxide, causing bubbles and craters in freshly applied polyurethane paint. In addition, blow down air lines at least every hour to remove water. Reaction of catalyst with water is evident by an accelerated rate of increase in viscosity.

Thoroughly agitate the resin component (preferably with a mechanical shaker) and stir the catalyst with a wooden paddle in an exhaust ventilated booth or a well ventilated area and pour into separate metering containers. Mix three parts resin (Component A) with one part catalyst (Component B) by volume, unless otherwise specified by the manufacturer, and agitate thoroughly. Induction time (dwell time) or a waiting period is not required before applying the coating. Use only catalyst and resin from the same manufacturer and the same lot, and do not mix more material than will be used in a 4-hour period. It is preferable, however, that the amount of material mixed at one time be limited to that usable in two hours. This polyurethane coating requires continuous agitation during spraying application to prevent settlement of pigment and ensure uniformity of color.

6.12.7.5 APC Mixing. Follow mixing instructions in Paragraph 6.12.7.4.

### NOTE

Do not use catalyst (component B) from standard MIL-PRF-85285 coatings or catalyst from other APC colors.

6.12.7.6 Thinning.**WARNING**

PCBTF, NSN 6850-01-399-0676, is combustible and an irritant to eyes, skin, and respiratory tract. Eye and skin protection required. Disposable 8 mil nitrile gloves, splash goggles, tyvek/cloth coveralls are the recommended PPE. Use in well ventilated areas.

**NOTE**

PCBTF, NSN 6850-01-399-0676 is exempt as a VOC or HAP by the EPA and by 48 states and will not change compliance of high solids coatings to air quality regulations.

Cure accelerators are not authorized for use in polyurethane when painting aircraft as they change the cured properties and integrity of the coating. It can be thinned with PCBTF (NSN 6850-01-399-0676); using up to 10% by volume as a recommended maximum for reduction of viscosity. The expected viscosity as thinned will be in the range of 8 to 29 seconds in a No. 4 Ford Cup (17 to 23 seconds in a No. 2 Zahn Cup), but it can be up to 30 seconds in a No. 4 Ford Cup (39 seconds in a No. 2 Zahn Cup) before thinning.

**6.12.7.7 Application.** MIL-PRF-85285, Type I is for application on properly prepared and primed substrates. Surfaces shall be prepared per Chapter 2 and primed with MIL-PRF-23377, Type I, Class C; TT-P-2760, Type I, Class C; or MIL-PRF-85582, Type I, Class C2. Steel surfaces shall be phosphate treated or coated with MIL-C-8514 or DOD-P-15328 wash primer and primed with the same primers listed above. Use Type II of these primers if low IR reflectance is required. This coating may be applied by airless, air assisted airless, HVLP, or electrostatic equipment after proper mixing of the base and catalyst. Apply the coating in one wet cross-coat or two coat with the second coat applied crosswise to the first after cure time of 4 hours. The dry film thickness shall be 1.6 to 3.2 mils each coat per Table 5-2 (2.7 to 4.0 mils wet film). Air assisted airless is preferable. For air assisted airless, use No. 617 tip for 12 inch fan and No. 517 tip for 10 inch fan. Atomize at eight to ten PSI at the tip with the trigger pulled to conform to the HVLP requirement of the NESHAP.

**6.12.7.7.1 APC Application.** Follow application procedures of Paragraph 6.12.7.5. In addition, maintain a wet edge during each application. After the first coat, the coating should be air dried 15-60 minutes at 75° F/ 24° C ±5° F/15° C before application of the second coat. It is normal for occurrences of mottling or “tiger striping”. This condition typically disappears after coating has reached full cure. Although the visible gloss of camouflage APC will appear to

be greater than conventional MIL-PRF-85285, APC still meets the requirements of the military specification.

**6.12.7.7.2 Maintenance Painting.** Maintenance painting (touch-up) of APC shall be accomplished using same procedures as for conventional polyurethane coatings listed in Chapter 5. Although APC and conventional MIL-PRF-85285 coating are compatible, it is recommended to use the same material as the previously applied coating system for maintenance painting. If both materials are used, a significant color mismatch will develop as the two coatings age due to APC’s superior color retention.

**6.12.8 Curing of Complete Polyurethane System.**

The cure schedule for polyurethane coatings shall be followed. Aircraft shall not be operated until 72 hours has elapsed at a temperature of 75° F or higher, after the topcoat application is completed. If the temperature is less than 75° F at anytime during the cure cycle, it is preferable to wait a full seven days before flying the aircraft.

- a. Cure time before handling, taping, masking etc., is 6 hours minimum. Time may be reduced to 4 hours if temperature and humidity reach upper limit (90° F and 80% RH). Low temperature and low humidity (60° F and 30% RH) retards cure rate to 12 hours minimum.
- b. Curing time before movement from controlled hangar environment at a temperature of 75° F or higher is 6 hours minimum after application of last paint coat. Aircraft may then be moved to another location with a controlled environment of 75° F or higher to continue its 72-hour cure.
- c. Curing time before decal application, 8 hours minimum.
- d. Curing time before engine run up, 30 hours minimum.
- e. Curing time before wet tape test, 48 hours minimum.
- f. Curing time before flight, 72 hours minimum.
- g. Curing time for maintenance painting of polyurethane system at 75° and 50% RH and higher: (Lower temperatures and relative humidity require longer cure times.)
  - (1) Complete leading edges (All), complete control surface (All), major skin panels 9 square feet and over, and engine intake, 72 hours minimum.
  - (2) Skin panels less than 9 square feet, fasteners, rivet heads, screw heads, and minor chipped and scratched areas, less than 36 square inches, 30 hours minimum.

**6.12.9 Coating Compound (Wash Primer), Metal Pre-treatment, Resin-Acid, Specification MIL-C-8514.**

**6.12.9.1 Characteristics.** The term “wash primer” designates a specific material which combines the properties of

inhibitive wash coat or metal conditioner with the properties of the conventional anticorrosive primer. This coating is furnished with a resin component and an acid component, which are mixed just prior to use. The resin component consists of an insoluble zinc chromate and magnesium-silicate in a polyvinyl-butyril resin and alcohol vehicle. The acid component is phosphoric acid, ethyl alcohol, butyl alcohol, and water. Wash primers can be formulated that are equally effective over iron, steel, aluminum, treated magnesium, copper, zinc and a wide variety of other metals. The advantages of wash primers used by the Air Force are listed below.

- Apply easily and dry rapidly.
- Useable over wide ranges of temperatures and humidity.
- Can be applied to a variety of metals with good results.
- Provide temporary protection until protective coating is applied.
- Prevent or retard under-film corrosion.
- Exhibit high degree of adhesion to metals.
- Upgrade performance of subsequent protective coatings.

**6.12.9.2 Uses.** The primary purpose for wash primer is as an intercoat between the base metal and the subsequently applied primer coat. Primers that may be applied over wash primer are MIL-PRF-23377, MIL-PRF-85582, TT-P-2760, and TT-P-1757. This primer will not provide lasting protection. It is an alternate for MIL-C-5541/SAE AMS-C-5541, Class 1A conversion coating on aluminum alloys.

#### NOTE

Do not use wash primer over one year old without first checking its quality.

**6.12.9.3 Mixing.** Thoroughly mix each of the two components using a mechanical shaker or approved equivalent to reincorporate any settled portion. Slowly add one part (by volume) acid component in small portions to four parts resin component with constant stirring. Never add the resin component to the acid component.

#### WARNING

MIL-C-8514 is flammable and moderately toxic to eyes, skin, and respiratory tract. Eye and skin protection required. Good general ventilation is normally adequate.

#### NOTE

The acid component is not a thinner but a necessary activator. Do not vary the ratio of acid to resin. Too little acid content in the wash primer will result in poor coating adhesion and an excess of acid will cause serious brittleness.

**6.12.9.4** The pigment portion of the resin component may settle and develop a hard cake during prolonged storage. When this condition is encountered, pour the top liquid into a separate container and break the hard cake with a paddle. Gradually add the poured-off liquid in small amounts with continuous stirring until the cake is reincorporated.

**6.12.9.5 Pot Life.** Polymerization starts immediately when the acid and resin component are mixed, restricting the pot life of the wash primer. If the temperature is below 90° F, mix only the amount of wash primer that will be used in a 4-hour period. Limit the quantity to a 2-hour supply if the temperature exceeds 90° F.

**6.12.9.6 Thinning for Spraying.** To spray uniformly thin films of wash primer and to lessen cobwebbing, the wash primer may require thinning with ethyl alcohol conforming to Specification A-A-59282 (NSN 6810-00-127-4532). The correct spraying viscosity is 19 to 24 seconds in a No. 4 Ford Cup (24 to 31 seconds in a No. 2 Zahn Cup). Wash primer material may be suitable for spraying without thinning and can actually be sprayed without apparent difficulty. However, sometimes this results in a rough appearance which transmits through to the topcoat, necessitating light scuff sanding to give satisfactory appearance. Also, it will be more difficult to obtain the correct uniform dry film thickness without thinning.

**6.12.9.6.1 Normal Atmospheric Conditions.** Under normal weather conditions (35 to 70 percent relative humidity and 50° F to 90° F), thin with ethyl alcohol or a mixture of 90 parts ethyl alcohol to 10 parts butyl alcohol. A volume of diluent (thinner) equal to the volume of acid component is generally sufficient to obtain a wash primer of adequate spraying viscosity. Use the ethyl-butyl alcohol mixture diluent only at the high end of the humidity temperature range within the normal atmospheric condition since butyl alcohol increases drying time.

**6.12.9.6.2 Low-Humidity Conditions.** Under low-humidity conditions (less than 35 percent relative humidity) and moderate temperatures (70° F to 80° F) prevalent in heated areas during winter months, the normal dilution specified above will result in poor intercoat and system adhesion of subsequently applied topcoats. This difficulty

may be minimized by thinning with one part by volume of thinner to five parts by volume wash primer with a thinner composed of two parts (by volume) of distilled or demineralized water and one part (by volume) of a 90:10 mixture of ethyl alcohol: butyl alcohol. The above thinner composition is a starting point and should be modified where local conditions warrant. Table 6-1 shows the amount of each component generally necessary to furnish a satisfactory wash primer.

**6.12.9.6.3 High Humidity Conditions.** Blushing of the reduced wash primer may occur under high humidity conditions (approximately 70 percent relative humidity or more). Subsequently, applied topcoatings will not adhere to blushed films. Blushing may frequently be eliminated by adding to or substituting for the higher evaporation rate ethyl alcohol, a lower evaporation rate blush-retardant solvent, such as

ASTM D2627, diactone alcohol, or butyl alcohol. The diactone alcohol evaporates slowest and offers maximum blush resistance.

#### NOTE

Do not use lacquer thinner to reduce wash primer since it will increase the drying time of the wash primer and, in case of high humidity, may prevent drying of the wash primer for a period of several days.

**6.12.9.7 Film Thickness.** The proper dry film thickness is 0.2 to 0.3 mil. (wet film 0.6 mil). The wet film thickness may be measured with a Nordsen Wet Film Thickness Gauge or similar gauge.

**Table 6-1. Thinning Ratio (Volume) for Wash Primer MIL-C-8514**

Component	Quantity	Quantity	Quantity
Resin	4 gallons	1 gallon	4/5 gallon
Acid	1 gallon	1 quart	1/5 gallon
Distilled Water	85 ounces	21 ounces	17 ounces
Ethyl Alcohol	39 ounces	10 ounces	1 ounce
Butyl Alcohol	4 ounces	1 ounce	1 ounce

#### NOTE

Place a small test panel(s) adjacent to the item being coated, and measure the film thickness on the test panel to assure proper wash primer thickness.

**6.12.9.8 Application of Wash Primer.** Wash primer may be applied by spraying, brushing, roller coating, or swabbing on a clean metal surface. Spray the wash primer as a thin film so that a continuous film may be obtained. A single pass with the spray gun held 10 to 12 inches from the surface is adequate. Do not attempt to get a full hiding coat as this results in excessively thick coating. Too thick a coating is undesirable because of poor adhesion of subsequent coatings due to entrapped alcohol in the wash primer. Immediately remove thick coatings with alcohol and reapply the coating properly. Do not attempt to obtain a thin film by holding the spray gun more than 12 inches from the surface as this results in a dry, powdery film deposit that seriously impairs the adhesion of the subsequent finish system.

#### NOTE

- Applying wash primer over oil residues results in the dried wash primer having a shiny appearance. Strip, reclean, and re-coat such areas.
- DOD-P-15328, Coating Pretreatment (Formula No. 117 for metals), covers a material very similar to Specification MIL-C-8514 material. The main difference is the fineness of grind of the pigment. It may be used as an alternate for MIL-C-8514.

**6.12.9.8.1 Low-Humidity Application.** Wash primer applied under low humidity conditions (less than 35 percent) has a generally good resistance to fingernail scratches, but adhesion of subsequently applied primers or topcoats will be poor. Check the temperatures and relative humidity frequently, and stop work when low relative humidity conditions are encountered. If the relative humidity in the paint area



cannot be raised, discard or set aside the wash primer being used and mix and thin a new batch following the instructions in Paragraph 6.12.5.3 and Paragraph 6.12.5.4.

**NOTE**

Isopropyl alcohol shall not be substituted for ethyl alcohol in thinning wash primer as the addition of water in the thinning process for low humidity will cause the material to gel.

6.12.9.8.2 High-Humidity Application. Wash primer will blush, resulting in a whitish color caused by moisture condensation in the film and be easily scratched with a fingernail when applied under high relative humidity and high temperature conditions. When blushing is encountered, discard or set aside the wash primer being used and mix and thin a new batch following instructions in Paragraph 6.12.5.3 and Paragraph 6.12.5.4.

6.12.9.9 Drying Time. Wash primer dries to handle within a few minutes, but, allow it to dry for at least 60 minutes but no more than 4 hours, depending on local temperatures and humidity conditions, before topcoating. For best results, apply the subsequent primer coat as soon after the wash primer is tack free because intercoat adhesion begins to degrade slowly on aging indoors and rapidly when exposed to the sun. Best intercoat adhesion will generally be obtained after 1 to 2 hours drying under normal conditions. The actual drying time required can be determined for local conditions by applying wash primer to several test panels and performing the wet tape test on a primer film over the wash primer after various drying periods. This test should be done prior to wash primer application to the end item.

**NOTE**

Do not apply primer on any wash primer when it has dried for more than 4 hours. Remove aged wash primer, thoroughly clean metal, and apply new wash primer coating before applying a primer.

6.12.9.10 Sanding of Wash Primer Coating. To obtain the full gloss of exterior topcoat, lightly scuff sand with dry 320 to 400 grit abrasive paper to remove over-spray and smooth out nibs. Remove dust resulting from this operation with a tack rag before applying the primer.

6.12.10 Primer, Coating, Inorganic, Zinc Dust Pigmented, Self-Curing, For Steel Surfaces, Specification MIL-P-38336/SAE AMS-P-38336.

6.12.10.1 Characteristics. This is a ready-to-mix two-component, inorganic zinc, corrosion inhibitive primer consisting of a liquid inorganic vehicle and zinc dust pigment in separate containers. It is intended for use on steel and galvanized surfaces, above or below grade, that are subjected to damp or wet environments, i.e., high humidity of 70% or above, water condensate or splash, and marine or severe weather environments. It has high resistance to hydrocarbon solvents and withstands temperatures up to 750° F. It provides galvanic protection to steel surfaces. Thorough cleaning is required to remove rust, scale and oil from surfaces so the primer can make intimate electrical contact with the steel.

6.12.10.2 Uses. The primer is for application directly to steel surfaces with or without phosphoric acid treatment (Reference TO 1-1-691) which have been roughened mechanically preferably by abrasive blasting. It may be applied to damp, but not to wet surfaces, and may be used alone or with a variety of proprietary items, applied in accordance with vendor's instructions. Inorganic zinc primer may appear in versions requiring water as a diluent. Storage stability or "Shelf Life" is one year in an unopened package. It is not for use in direct contact with acids, alkalis or salts. MIL-P-38336/SAE AMS-P-38336 inorganic zinc primer is the preferred primer for use in high humidity application.

6.12.10.3 Mixing.

**WARNING**

Most inorganic primers contain flammable solvents. In confined areas, proper respiratory protection must be worn. Contact the Base Safety Office and the Bioenvironmental Engineer for specific details.

The primer is supplied as a two component kit. The liquid vehicle container holds an amount which when mixed with the zinc dust pigment provides the specified volume of primer. Mix the component materials in the proportions furnished as follows:

- a. Mix the vehicle portion thoroughly until all solids are in suspension using hand paddles, mechanical devices or any powered stirrers available.
- b. Sift the zinc dust pigment slowly into the mixed vehicle while stirring continually. Use either hand paddles or a small powered stirrer. Do NOT use a powered shaker type paint agitator to disperse zinc dust in the vehicle.

- c. If it is required to mix batches smaller than the full unit size, strictly maintain the proportions of vehicle and pigment specified by the manufacturer.

#### NOTE

Proportions customarily are given by weight. If mixing less than a full kit, it can be done by using the volume of the vehicle and the weight of the zinc pigment. Determine the fraction of the total kit volume of the vehicle being used and multiply the total weight of the zinc pigment in the kit by this fraction, and weigh out that amount of zinc pigment and mix with the volume of vehicle being used. An accurate scale is required that will weigh up to 2.6 kilograms to the nearest 0.1 of a gram. A scale which meets these requirements is the Triple Beam 760W Balance made by Paul N. Gardner Co., Inc.; 316 NE First St.; Pompano Beach FL 33060.

- d. Stir until zinc pigment is thoroughly wetted and the mixture is free of lumps. If small lumps persist, strain the mixture through a 30 mesh wire screen or through double or triple thickness of cheesecloth before using.
- e. When application is by brush, stir moderately and often to maintain a homogeneous mixture throughout application.

#### 6.12.10.4 Thinning.



Use A-A-59282 (NSN-6810-00-127-4532) ethyl alcohol only where no fire hazards exist. Within enclosed areas and the missile silos use the A-A-59106 ethylene glycol monoethyl ether.

Package viscosity is generally appropriate for brush application. Adjust the viscosity for spraying by thinning in accordance with the manufacturer's instructions using the following:

- The proprietary thinner(s) called out by the manufacturer.
- Either A-A-59282 ethyl alcohol, (NSN-6810-00-127-4532) or A-A-59106 ethylene glycol monoethyl ether.

6.12.10.5 Application. HVLP spray application is the preferred method; however, the material can be applied by brush. Airless spraying methods are not recommended, as the higher pressure involved (1200-2200 PSI) can result in the rapid packing of the zinc pigment at valves and orifices.

6.12.10.6 Drying Time. On dry surfaces at 75° F, it is tack free in 30 min. and fully cured in 4 hours. On wet surfaces at 75° F, it is tack free in 1 hour and fully cured in 6 hours.

#### NOTE

- Materials can vary to some extent under the controlling MIL-P-38336/SAE AMS-P-38336. The specification requires inclusion of mixing, thinning, application and curing instructions in the package. Where the manufacturer's application instructions differ appreciably from these general supplementary instructions, the manufacturer's instructions shall apply.
- It is difficult to impossible to measure viscosity of inorganic zinc primer using the standard authorized measuring devices; therefore, it will not be done. Use the proportions of thinner recommended by the manufacturer, adjusting further in small degrees to suit special conditions using the painters judgment. Just prior to spraying, wet or damp surfaces shall be wiped clear of moisture films and, (where possible), then solvent wiped with clean cloths wetted with A-A-59282 ethyl alcohol (NSN 6810-00-127-4532) or TT-I-735 isopropyl alcohol. When using spraying technique, adjust material tank pressure as recommended by the manufacturer or, in absence of this information, to 12-15 PSI, or less.

6.12.11 Primer Coating For Steel Surfaces, Specification MIL-PRF-26915. This specification covers two types of primer, each with two different classes for use on steel surfaces. Both types and classes are compatible with MIL-PRF-85285 polyurethane topcoat material.

6.12.11.1 Characteristics. Traditionally, this has been an organic zinc dust pigmented primer used for galvanic protection of steel surfaces on ground support equipment. This primer is furnished in two types and two classes: Type I, non-water reducible, Type II (DEFT Corp., PN 44-GY-16, CAGE 33461) water reducible, Class A maximum VOC content of 340 g/L (2.5 lbs/gal), and Class B maximum VOC content of 250 g/L (2.1 lbs/gal). This primer may come in two, three, or four-component kits.

6.12.11.2 Use. The primer is used to provide galvanic protection for steel ground support equipment surfaces. Use two coats (4-6 mils dry film thickness) for severe exposure such as on steel that is normally subjected to outside exposure, condensing moisture, or corrosive atmospheres. If color or finish texture is important, overcoat with one coat of MIL-PRF-85285, Type I, II or III polyurethane.

6.12.11.3 Mixing. Mix in accordance with manufacturer's instructions. To prevent settling of the pigment, continuous agitation of the coating is necessary during application.



6.12.11.4 Thinning. Package viscosity is generally appropriate for brush application. Adjust viscosity of the primer for spraying by thinning in accordance with the manufacturer's instructions.

6.12.11.5 Application. Apply by spray (hot or cold method) to solvent-cleaned, phosphoric acid treated or sand-blasted steel. HVLP spray application is the preferred method; however, the material can be applied by brush, but only to small areas. Airless spray methods are not recommended, as the higher pressure involved (1200-2200 PSI) can result in the rapid packing of the pigment at valves and orifices.

**NOTE**

- Vendor's materials can vary to some extent under the controlling Specification MIL-PRF-26915. The specification requires inclusion of mixing, thinning, application, and curing instructions in the package.
- It is very difficult to measure viscosity of this primer by means of the standard authorized measuring devices; therefore, it will not be done. Use the proportion of thinner given by the manufacturer, adjusting further in small degrees to suit special conditions in accordance with judgment of the painter.

6.12.11.6 Drying Time. At 75° F and 50% RH, it is tack free in 1 hour and is fully cured in two hours. It can be topcoated after 1 hour and up to 24 hours drying.

6.12.12 Paint, Aluminum, Heat Resisting (1200° F) TT-P-28.

6.12.12.1 Characteristics. This is heat resistant aluminum paint capable of withstanding temperatures of 1200° F. It is not intended to provide protection against corrosion as a primary function. In high temperature areas on aircraft where other paints will not survive, it will provide limited protection, primarily for steel components.

6.12.12.2 Uses. Can be used on superheated steam lines, boiler casings, boiler drums, superheated headers, other similar high temperature applications, and areas on aircraft where operating temperatures exceed 400° F.

6.12.12.3 Thinning. As recommended by the manufacturer.

6.12.12.4 Mixing and Application. Because the pigment settles out of suspension and cakes in the bottom of the can, this coating requires thorough mixing on a mechanical paint shaker before application. Apply by brush or by spraying after thinning as recommended by the manufacturer.

6.12.12.5 Drying Time. When air drying at 75° F, it is tack free in 1 hour, full hard in 3 hours, and fully cured in 24 hours. Baked at 400° F, it is fully cured in 1 hour.

6.12.13 Enamel, Alkyd, Gloss, Low VOC Content, TT-E-489.

6.12.13.1 Characteristics. This is a high-gloss, air-drying, alkyd enamel with excellent weather resistant properties. It is flexible and has satisfactory gloss and color retention. It is lead and chromate free and VOC compliant with a maximum of 420 g/L (3.5 lbs/gal).

6.12.13.2 Uses. It is used on properly pretreated and primed exterior and interior metal and wood surfaces. Its main use is for refinishing automobiles, construction equipment, machinery, gasoline pumps, trucks, buses, passenger and freight railway cars, metal drums (exterior), metal signs, metal railings and fences, and marine use (above water).

6.12.13.3 Thinning. Use enamel thinner conforming to A-A-3007. Add one pint of Thinner per gallon of enamel or the amount recommended by the manufacturer.

6.12.13.4 Application. Brush-apply as issued. Spray by HVLP methods after thinning.

6.12.13.5 Drying Time. This enamel air dries tack-free in two hours, hard in eight hours, and full cure in 48 hours. It may be recoated after 24 hours. Times are listed for 75° F and 50% RH.

6.12.14 Enamel, Heat Resistant (204° C or 400° F), A-A-3054.

6.12.14.1 Characteristics. This is a one-component, heat-resistant paint.

6.12.14.2 Uses. For coating metal surfaces subjected to temperatures not higher than 400° F. Typical uses are steam pipes, boiler fronts, automotive engine parts, and similar applications.

6.12.14.3 Thinning. As recommended by the manufacturer.

6.12.14.4 Application. Apply by brush method as issued or by HVLP spray methods after thinning as required.

6.12.14.5 Drying Time. At 75° F and 50% RH, this enamel is tack free in two hours, and fully cured in 72 hours. It can be recoated after air drying 24 hours.

6.12.15 Coating, Sprayable, Strippable, Protective, MIL-PRF-6799.

6.12.15.1 Characteristics. This is a water emulsion, protective, strippable, sprayable, multi-coat coating for application over metallic, painted, and plastic surfaces that comes in one type with several classes.

Type II, Class 1	Base coat (black)
Type II, Class 5	Topcoat (white or olive drab)
Type II, Class 6	Topcoat (white)
Type II, Class 7	Topcoat brushable

6.12.15.2 Uses. These materials are used to protect equipment and aircraft during shipment and storage.

6.12.15.2.1 Type II, Class 1. This is a black material intended for use as (1) a strippable, protective coating for acrylic plastic bulk materials and assemblies containing acrylic plastics when the protected item is shipped fully covered or stored under cover, and (2) as a basecoat for Type II, Class 5 and Class 6 materials.

6.12.15.2.2 Type II, Class 5. This is a white or olive drab material intended to be used only as a topcoating for Type II, Class 1 material. This combination protective system serves as a sprayable, strippable, protective coating for application on metallic, painted and plastic surfaces, such as entire aircraft, missiles, rockets and transportation vehicles during outdoor storage and overseas deck-loaded shipments. This material should be applied to a dry film thickness of  $3 \pm 1$  mils.

6.12.15.2.3 Type II, Class 6. This is a white material intended to be used only as a topcoating for Type II, Class 1 material. This combination protective system serves as a sprayable, strippable, protective coating for applications on metallic, painted and plastic surfaces, such as entire aircraft, missiles, rockets, and transportation vehicles during outdoor storage and overseas deck-loaded shipments. This material should be applied to a dry film thickness of  $6 \pm 1$  mils.

6.12.15.2.4 Type II, Class 7. This material is intended as a brushable coating for patching or repairing damaged Class 5 or Class 6 coatings.

6.12.15.3 Thinning. Thin as required per the manufacturer's instructions.

6.12.15.4 Application. Apply by HVLP spray methods. Class 5 material may be applied at  $75 \pm 15^\circ$  F and  $50 \pm 10\%$  RH. Class 6 material may be applied within a temperature range of  $50^\circ$  F to  $115^\circ$  F and  $50 \pm 10\%$  RH, but the pot life and cure time will be much longer at the lower temperature and much shorter at the higher temperature as compared to those at  $75^\circ$  F.

6.12.15.5 Drying Time. Air dry at  $75^\circ$  F and 50% RH:

Type II, Class 1	3 hours
------------------	---------

Type II, Class 5	2 hours
Type II, Class 6	2 hours
Type II, Class 7	2 hours

#### 6.12.16 Resin Coating, Unpigmented, For Engine Components and Metal Parts, MIL-PRF-3043.

6.12.16.1 Characteristics. This is a permanent thermo-setting resin coating free from drying and non drying oils and cellulose. The resin coating is baked on, and provides a transparent green film on the surface.

6.12.16.2 Uses. The coating is used as a permanent corrosion preventative, oil resistant coating for metallic non-bearing surfaces of engine parts, airframe components, magnesium parts, gun mounts, gear housings, and other components. The material is specifically used on the interior surfaces of droppable steel tanks and tubing of methylbromide or trifluorobromethane fire extinguishing systems.

6.12.16.3 Thinning. As recommended by the manufacturer.

6.12.16.4 Application. Apply by dip or spray at room temperature.

6.12.16.5 Drying Time. The coating air dries to handle in 30 minutes at room temperature. Fully cure by baking in oil or by oven baking.

6.12.16.5.1 Baking in oil. Air dry for 16 to 24 hours and immerse in MIL-PRF-7808 hot lubricating oil for 15 minutes.

6.12.16.5.2 Oven baking. Air dry for one hour followed by 30 minutes baking at  $325^\circ$  F.

#### 6.12.17 Coating Kit, Epoxy, For Interior of Steel Fuel Tanks, MIL-PRF-4556.

6.12.17.1 Characteristics. This is a kit containing a primer and a topcoat, each of which are two-component kits of epoxy coatings. This coating is for protecting interior surfaces of steel tanks used for transportation and storage of fuels. It is lead and chromate free and has a maximum 340 g/L (2.8 lbs/gal) VOC content.

6.12.17.2 Uses. This coating is intended for protection of sand blasted interior surfaces of mobile and stationary mild steel tanks and auxiliary handling equipment used for the storage and transportation of military fuels and oils.

6.12.17.3 Mixing. Thoroughly mix Component A, preferably using mechanical agitation, and then add one part Component B to four parts by volume of Component A.

6.12.17.4 Thinning. Thin as recommended by the manufacturer.

**TO 1-1-8**

6.12.17.5 Application. Apply by HVLP spraying methods (hot or cold method) or as recommended by the manufacturer within the six hours at 75° F/24° C pot life of the material.

6.12.17.6 Drying Time. Set-to-touch - 5 hours and dry hard 18 hours.

6.12.18 Coating, Corrosion Preventive, For Aircraft Integral Tanks, MIL-C-27725/SAE AMS-C-27725.

6.12.18.1 Characteristics. This is a polyurethane material available in two types each with two classes. It is fuel resistant and is used to provide protection of aircraft fuel tanks against corrosion from contaminants and water in fuels.

Type I	A one-part formulation polyurethane coating.
Type II	A two-part formulation polyurethane coating.
Class A	General use (does not comply to most air pollution regulations, may be used only where not prohibited).
Class B	Limited use (For areas requiring regulation of air pollution caused by emissions of certain solvents that produce smog).

6.12.18.2 Uses. This coating is intended for the protection of aircraft integral fuel tanks against corrosion in a service temperature range of -65° F to +250° F.

6.12.18.3 Mixing.

**WARNING**

- MIL-C-27725/SAE AMS-C-27725 is flammable and toxic to eyes, skin, and respiratory tract. Eye and skin protection required. Consult Bioenvironmental Engineering to determine proper respiratory and ventilation requirements.
- The coating material contains harmful solvents and free isocyanates. Inhalation of vapor may cause irritation of the nose, throat, and lungs, and may cause sensitization. Vapors or liquid contact with the eyes or skin may cause severe irritation.
- Safety and health procedures are mandatory and no deviation will be permitted except by written approval of the Office of Safety and/or Bioenvironmental Engineer. It is the responsibility of the immediate supervisor to ensure that all safety and health procedures are followed without deviation.
- Personnel applying the coating by spray or brush or those required to reenter coated fuel tanks before complete cure shall be protected by wearing: full-face air supplied respirator with air flowing before tank entry until exiting the tank; white cotton coveralls; cotton booties or cotton socks; rubber chemical resistant gloves or surgical type gloves; and cotton head covering.
- All clothing shall be washed after each use.

**WARNING**

- Place all material used to mop up spilled coating or runs in coating into water immediately. A small container of water shall be provided in the immediate area.
- Blowers, which are grounded and bonded to the aircraft, shall be circulating air in the fuel cells/tanks before and during entry of personnel to perform any operation such as cleaning. Air shall flow so that vapor will be carried away from the operator.
- MIL-C-27725/SAE AMS-C-27725 has a flash point of 266° F open cup, therefore, can present a fire hazard when heated or atomized. Some materials used in this operation have flash points as low as 20° F and will ignite if exposed to a flame or spark.
- If MIL-C-27725/SAE AMS-C-27725 is spilled in the repair area, evacuate the area and call the Fire Department. Neutralize with strong ammonia solution, then flush with water.

**NOTE**

Do not mix more material than can be used in a 5-hour period.

Mix coating components within an approved ventilated paint booth. If a booth is not available, personnel shall wear an air-supplied respirator, and mixing shall be accomplished so that vapors are exhausted to an area as approved by the Bioenvironmental Engineer. Mix and blend the two components of the coating thoroughly for a minimum of 5 minutes. Do not mix in contaminated containers. Stir the material with

a metal spatula. Keep empty containers and those containing mixed and unmixed coating tightly closed when not in use.

6.12.18.4 Application.



The dry film thickness of this coating shall be between 0.8 and 1.2 mils, see Table 5-2. Runs and sags shall be mopped immediately to prevent thick spots. Thicknesses over 1.2 mils result in cracking, flaking and peeling of coating while those less than 0.8 mils do not provide adequate protection. Measure the wet film thickness with a wet film gauge and control the wet film per the manufacturer's requirements.

After the tank surface is thoroughly dry and immediately prior to application of the coating, gently clean the area to be coated with lint-free cleaning cloth wet with MIL-C-38736/A-A-59281 cleaner and wipe dry. Do not allow the cleaner to air dry. Do not abrade the chemical conversion coating film. Clean small areas starting from the top and farthest from the access door and work down and out using clean lint-free cloths/pads. The exception is, for large repair areas where there must be alternately cleaning, sealing, and coating of an area and then repeating in the next area while working toward the access door. Use caution not to contaminate a previously cleaned area, and reclean immediately if it occurs. Spray all accessible areas when practical; areas that cannot be sprayed shall be coated by brush application. Access doors and removable parts shall be spray coated in a spray booth and cured in an area with circulating fresh air. Personnel entering the curing area shall follow all precautions stated in the "warning" When spraying, apply a light double pass to cover the surface. Take care to prevent runs and puddles; and if they occur, remove them immediately.

6.12.18.4.1 Prior to starting application of MIL-C-27725/SAE AMS-C-27725 and at each change of painters, spray or brush a small strip of aluminum prepared in the same manner as described above. Properly adjust the flow of material from the spray nozzle to provide the proper coating thickness of 0.8 to 1.2 mils dry film.

6.12.18.4.2 Spray Application. Use a HVLP spray gun. Use a pressure feed tank with 5 PSIG and an atomizing air pressure of 35 PSIG. Pressure tanks shall be equipped with an agitator to provide proper pigment suspension. Immediately after use, the equipment shall be thoroughly cleaned with MIL-T-81772, Type II.

6.12.18.4.3 Brush Coating. A fine camel hair or soft hog bristle brush shall be used when applying this coating by brush. The material shall be stirred with a metal spatula every 3-5 minutes.

6.12.18.5 Drying Time. Curing MIL-C-27725/SAE AMS-C-27725 coating will be tack free in 4 hours under

normal conditions (75° F and 50% humidity). Cure may be accelerated after a minimum of 4 hours cure at 75° F by adding heat up to 120° F. The state of cure can be tested by rubbing a test spot with a gauze pad wet with MIL-T-81772, Type II thinner. If bare metal is exposed after 50 double strokes of the pad at moderate pressure, the coating is not completely cured.

6.12.19 Coating Compound, Nonslip (For Walkways), A-A-59166.

6.12.19.1 Characteristics. A nonslip compound formulated in a hand brushable consistency that is fuel and fluid resistant. These coatings are available in several colors. This material is compliant with the NESHAP VOC requirements of 420 g/L (3.5lbs./gal).

- Type I This is a smooth coating without grit formulated primarily for brush application.
- Type II This is a rough material formulated primarily for brush application containing grit as an integral part of the coating.

6.12.19.2 Uses. A non-slip is used on aircraft exterior walkway surfaces to protect personnel from falling while walking on aircraft surfaces. May also be used on vehicles, maintenance ramps, steps, ladders and similar areas.

- Type I Used along leading edges of aircraft that fly less than 250 mph and on other adjacent surfaces of aircraft where the roughness of the Type II coating is undesirable due to aerodynamic considerations.
- Type II Material used along trailing edges and adjacent surfaces in cases where maximum non-slip qualities are essential and aerodynamics are not affected.

6.12.19.3 Thinning. If thinning is necessary, use the solvent recommended by the manufacturer. Adjust the viscosity for spray application by thinning to 21 to 27 seconds in a No. 2 Zahn Cup (16 to 21 seconds in a No. 4 Ford Cup).

6.12.19.4 Mixing and Application. Walkway coatings are applied to primed surfaces, prior to application of final topcoat of aircraft coating systems. The topcoat applied over walkway coating shall be a single mist coat to reduce distinctive difference in color while not causing loss of non-slip features. Only the Type II (rough) coating shall be used under the topcoat of aircraft coating system. Type II



walkway coating need not be topcoated on interior walkways, ramps, steps, and doorways in high traffic areas. Before applying the non-slip coating, wipe primed surface with a clean lint-free cloth with solvent per Table 3-2, if necessary. Thoroughly mix the material, preferably with a mechanical shaker. The coating will normally have the proper viscosity for brush application. Application by brushing is recommended as the material is primarily formulated for this. Apply quickly and avoid brushing previously coated areas that are wet. Allow to dry at least 30 minutes but not more than 45 minutes between coats. Apply by spraying only when large areas are involved. Apply the coating (Type I and II) to a dry film thickness of 10 to 12 mils on aircraft exterior surfaces which weights 15 to 20 ounces per square yard for a Type I coating, and 20 to 25 ounces per square yard for a Type II coating. A 30 to 40 mil thick coating is recommended for non-aeronautical interior surfaces.

**6.12.19.5 Drying Time.** Type I and Type II coatings dry tack free in 15 minutes, for re-coating in 30 minutes, through in 6 hours, and to full hardness in 24 hours.

**6.12.20 Coatings, Polyurethane, Rain Erosion Resistant For Exterior Aircraft and Missile Parts, MIL-C-83231/SAE AMS-C-83231.**

**6.12.20.1 Characteristics.** This material is available in two types each with two classes. Type I is an electrically nonconductive rain erosion resistant coating, and Type II is an antistatic rain erosion resistant coating. Class A material is not dependant on moisture or high relative humidity for curing and Class B is dependent on them. Primer and topcoat components are furnished together as a kit. Specific aircraft directives specify the area to be coated and the materials to be used.

**6.12.20.2 Uses.** Classes A and B, Types I and II coatings are intended for protection of exterior laminated plastic parts of high-speed aircraft and missiles from rain erosion while in flight. Classes A and B, Type II coatings also discharge and dissipate static electricity, to prevent radio and radar interference.

**6.12.20.3 Thinning.** Thin as recommended by manufacturer and/or TO 1-1-24.

**6.12.20.4 Application.** Apply per TO 1-1-24 and/or as recommended by the manufacturer.

**6.12.20.5 Drying Times.** Drying times are per TO 1-1-24 and/or as recommended by the manufacturer.

**6.12.21 Coating System, Polyurethane, Non-Yellowing White, Rain Erosion Resistant, Thermally Reflective, MIL-C-83445/SAE AMS-C-83445.**

**6.12.21.1 Characteristics.** This material is one type of thermally reflective, non-yellowing, white rain erosion resistant polyurethane coating for glass fabric reinforced plastic laminated and other plastic parts used as exterior surfaces of aircraft and missiles.

**6.12.21.2 Uses.** This coating is intended to protect exterior laminated plastic parts of high speed aircraft and missiles from rain erosion and thermal energy while in flight. This coating cannot be used on radomes and other plastic parts that have a requirement for protection against static electrical charges, because it is not electrically conductive.

**6.12.21.3 Thinning.** Thin as recommended by manufacturer and/or TO 1-1-24.

**6.12.21.4 Application.** Apply as recommended by the manufacturer and/or TO 1-1-24.

**6.12.21.5 Drying Times.** Drying times are as recommended by the manufacturer and/or TO 1-1-24.

**6.12.22 Leading Edge Polyurethane Rain Erosion Resistant Tape.**

**6.12.22.1 Description and Use.** This tape is used to provide rain erosion protection for the wing, vertical and horizontal stabilizer, and any other leading edges aft of the engine intakes.

**6.12.22.2** Material and tools to be used are listed below in Table 6-2.



6.12.22.3 Installation.



- The temperature during application shall be at least 60° F. This may be accomplished with a ground heater for small areas.
  - Materials to make repairs or remove the tape must be available in case of errors in application.
  - Use only the tapes specified in Table 6-2 for application on aircraft exterior surfaces.
  - Adhesion promoters in Table 6-2 can not be substituted. If not available, do not apply tape.
  - Pre-scored liner material is very critical for proper installation. Without the slit liner, application is very difficult.
  - Do not apply tape to bare metal. Surfaces must at least be primed before film is applied. Allow primer to cure for 24 hours minimum before tape application.
- a. Feather, sand, prime, and paint the leading edge as required. Feathering chipped/peeled areas is vital for a quality installation. Recommend material be applied to aircraft in conjunction with touch-up painting.
  - b. Using the template fabricated per Table 6-2, align its centerline with the centerline of the leading edge. Mark the location of the top and bottom of the tape every two feet of the length on the leading edge component receiving tape.

**NOTE**

Varying widths of tape can be used depending of the amount on leading edge to be covered.

**Table 6-2. Leading Edge Tape Materials/Tools**

Material	Source	Use
Tape-width and color to match erosion area to be covered	3M Industrial Specialties Division Cage Code No. 52152	Leading edge rain erosion protection
Clear Tape NSN 9330-01-338-9994	AF Supply	Leading edge rain erosion protection
Adhesion Promoter PN 86 or PN 70 0701-8275-6	3M Company	Promote tape adhesion
Edge Sealer PN Epoweld 8173A Double bubble NSN 8040-00-092-2816	3M Company AF Supply	Seal tape edges and fill fastener head and other voids
Tape, masking	AF Supply	Masking of application area

- c. Mask using above marks as guides.



- Final sanding with anything coarser than A-A-58054 Type I, Grade A abrasive (very fine 240-320 grit) will adversely affect bond of tape.
- d. Abrade the masked off area to a smooth surface using A-A-58054 Type I Grade B followed by Grade A abrasive mat.
  - e. Remove residue with cheesecloth moistened with TT-I-735 isopropyl alcohol.



- Do not use rented or polyester rags to apply TT-I-735 alcohol as this may cause contamination of the surface.
- f. Fill all seams and fastener heads with MIL-PRF-81733, Type I, Class 2, Grade A sealant to eliminate any possible air pockets behind the film, trowel smooth/flush with razor blade or other suitable tool, and allow to cure before proceeding.
  - g. Use CCC-C-440, Type I, Class 2 cheesecloth to apply thin, but thorough coat of adhesion promoter per Table 6-2 to all application areas, including sealant, in the masked off area used to smooth seams and fastener heads.
  - h. Remove masking tape.

**Table 6-2. Leading Edge Tape Materials/Tools - Continued**

Material	Source	Use
MIL-T-21595/SAE AMS-T-21595, Type I		
Abrasive Mat A-A-58054, Type I, Class A or B	AF Supply	Smoothing and scuff sanding of area as surface preparation
Cheesecloth CCC-C-440, Type I, Class 2	AF Supply	Cleaning of area and smoothing of leading edge tape
Xacto knife or razor blade	Commercial	Trimming tape
Isopropyl alcohol TT-I-735A	AF Supply	Cleaning
Pin or 22 gauge or finer syringe needle	AF Supply	Air removal
Scraper, plastic	Local Manufacture	Tape removal
Template	Local manufacture from heavy paper other suitable material (width: same as tape. Length: same as leading edge. Mark center-line for alignment with leading edge center-line.)	Mark area which leading edge tape will be applied.
Paper wipers	3M Company	Cleaning
Adhesive remover PN 8098	3M Company	Adhesive removal

- i. Let adhesion promoter dry for 20 minutes.
- j. Cut a length of tape to fit leading edge plus four inches. Remove about three inches of the edge.
- k. With about two inches of the excess against the inboard edge of the component, align the film with the top template line and rub down with a tightly folded piece of CCC-C-440, Type I, Class 2 cheesecloth.
- b. Wipe area with TT-I-735 isopropyl alcohol and allow to dry.
- c. Apply heavy coat of edge sealer per Table 6-2 into seams and trowel flush with a razor blade.
- d. Apply edge sealer to all vertical edges exposed to air stream with an acid brush.
- e. Allow edged sealer to cure 24 hours before painting.

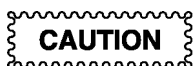

Ensure air bubbles do not build under film.

- l. Remove another three inches of the top liner section and rub film to surface.
- m. Repeat process above removing the next liner section and continue until film is completely bonded.
- n. Inspect work for air bubbles. Pierce bubbles with a needle or pin, and press air out before removing tool.
- o. Trim excess at the beginning and end of chipstrip where adhesion promoter was not applied.

6.12.22.4 Application of Edge Sealer. Proceed as follows.

- a. Scuff one inch on either side of all seams and edges where possible.

6.12.22.5 Repair of damaged area. Proceed as follows.

- a. Measure two inches either side of damage and apply masking tape along this line.
- b. Trim loose film from damaged area. Cut new film to fit area to be repaired.
- c. Scuff entire area with an A-A-58054, Type I Grade A nylon abrasive mat.
- d. Wipe area thoroughly with TT-I-735 isopropyl alcohol.
- e. Apply adhesive promoter per Table 6-2 to entire area. Allow to dry for 20 minutes.
- f. Apply film and rub thoroughly.

#### **NOTE**

Ensure air bubbles do not build under film.

## TO 1-1-8

- g. Inspect repair for air bubbles. Try pressing air out, allowing proper bonding. If not successful, insert needle or pin into the air bubble, and press out air before removing pin/needle.

6.12.22.6 Tape Removal. Remove tape by either of the following methods:

### 6.12.22.6.1 Removal Disc

- a. Using a pneumatic drill and 3M Adhesive Removal Disc (NSN 3460-01-447-8021) remove both tape and adhesive from damaged area.
- b. Trim edges as required.
- c. Wipe work area with CCC-C-440 Type I, Class 2 cheesecloth moistened with TT-I-735 isopropyl alcohol, turning cheesecloth frequently. Continue until cloth no longer shows residue.

### 6.12.22.6.2 Scraping and solvent removal

- a. Remove the tape by peeling it off. For repairs, remove tape 1/2 inch on either side of damage.
- b. Remove residual edge sealer by chipping with a plastic scraper.
- c. Mask work area.
- d. Apply adhesive remover per manufacturer's instructions.

- e. Allow to dwell long enough to soften adhesive.
- f. Remove old adhesive with plastic scraper. Repeat as necessary.
- g. Using an A-A-58054, Type I, Grade A abrasive mat soaked with TT-I-735 isopropyl alcohol, scrub area to remove all adhesive.
- h. Wipe work area with CCC-C-440 Type I, Class 2 cheesecloth moistened with TT-I-735 isopropyl alcohol, turning cheesecloth frequently. Continue until cloth no longer shows residue.

6.12.22.7 Painting Instructions. Proceed as follows.

- a. Scuff tape surface with A-A-58054, Type I, Grade B nylon abrasive mat.
- b. Saturate a clean lint free, cotton rag with ASTM D 329 acetone, and lightly wipe the tape surface.
- c. Wipe surface dry with a clean lint free, cotton cloth before the acetone evaporates.
- d. Paint tape surface with MIL-PRF-85285, Type I, color to match area, per Chapter 3.
- e. Air dry paint a minimum of 72 hours at 75° F before flying the aircraft.

## CHAPTER 7

### APPLICATION AND REMOVAL OF DECALS AND SILK SCREENING

#### 7.1 DECALS - GENERAL.

##### NOTE

National Stock Numbers (NSN's) for specific decals and related materials are to be obtained from Federal Supply Classes (FSC's) 7690, 9330, 9905, and others as found in Illustrated Parts Breakdowns (IPBs or -4 manuals) for specific aircraft. Also, see the current FED Log and the D043 System to convert specification and part numbers to NSNs. See Chapter 8 for requisitioning procedures and other related decal information.

Decals are specially prepared plastic film containing designs, words, numerals or colored marking stripes, which may be applied or attached to Air Force equipment as a method of marking or identification. Decals can be used in lieu of paint for internal and external markings and insignia as authorized in Chapter 8. Decals shall conform to A-A-59485 or commercial equivalent and are available in solid or perforated film. Decals with perforations shall only be applied over fully painted surfaces. For application to pressurized areas on aircraft exteriors, prepared (factory) perforated film shall be used to prevent blistering due to leaking rivets, seams, etc. Non-perforated, premasked decals, may be applied directly to the primer prior to applying the topcoat. Decals applied prior to the topcoat must be premasked with low tack translucent application/mask tape, leaving a 1/16 inch uncovered lip around the decal edge. This lip will allow the topcoat paint to seal the edge of the decal, eliminating the need for edge sealer. The mask is removed after the topcoat paint is allowed to cure. Decals are not authorized on unpainted surfaces.

##### 7.1.1 Surface Preparation.



Do not apply decals when the temperature is below 45° F as early failure or peeling will occur.

##### NOTE

If application of decals is required at temperatures of 45 to 60° F, the pressure sensitive adhesive must be activated per instructions supplied by the manufacturer.

The integrity of a decal installation is largely dependent upon proper preparation of the surface to which the decal is applied. Therefore, the following must be accomplished prior to application of decals to aircraft surfaces.

- a. Remove exceptionally oily or greasy contaminants using wipe solvents listed in Table 3-2.
- b. In areas where the decal will be applied, buff very lightly with very fine aluminum oxide abrasive mat per A-A-58054, Type I Grade A.
- c. Clean the entire application surface thoroughly with alkaline cleaner MIL-PRF-87937, or MIL-PRF-85570, in accordance with TO 1-1-691 on all old painted surfaces. This is not required on newly painted surfaces.
- d. Perform final cleaning of the application area with a lint free cotton cloth wet with TT-I-735 isopropyl alcohol. Wipe the area dry.
- e. Optional use of a gloss MIL-PRF-85285 polyurethane clear-coat applied to the area to be covered by aircraft decals for adhesion purposes on camouflage aircraft is authorized.

**7.1.2 Application Procedures For Decals and Colored Marking Stripes.** Application of decals authorized by Chapter 8 or system specific equipment or aircraft TO's is accomplished per the basic methods detailed below. These methods refer generally to simple shapes of the approximate sizes noted. Application of intricately cut shapes require the use of detailed application instruction supplied with the decal.

#### 7.2 SMALL DECALS AND MARKING STRIPES.

**7.2.1 Decals Up To 12 inches x 2 inches.** Remove entire backing from adhesive, align decal and press on one edge to surface with the finger. Hold the remainder of film taut and slightly away from surface until pressed down with plastic squeegee using firm, overlapping strokes (See Figure 7-1).



FO9603-28

**Figure 7-1. Applying Small Decal.**

**7.2.2 Film For Striping.** Pull off backing for approximately 12 inches, exposing the adhesive. Press-end in position and apply the striping as the backing is removed. Press firmly to surface with a plastic squeegee. Be sure all edges are firmly adhered (See Figure 7-2).

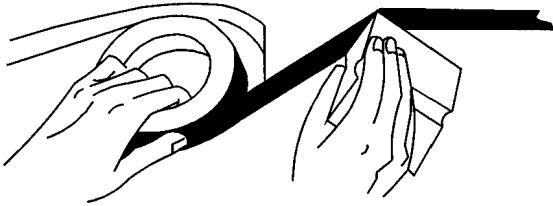

FO9603-29

Figure 7-2. Applying Marking Stripe

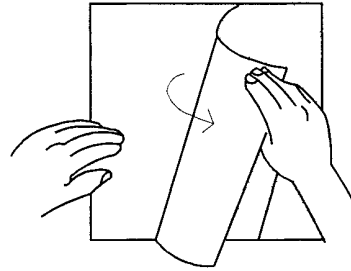

FO9603-32

Figure 7-5. Applying Large Emblems (Step 3)

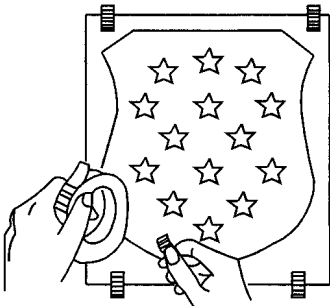

FO9603-30

Figure 7-3. Applying Large Emblems (Step 1)

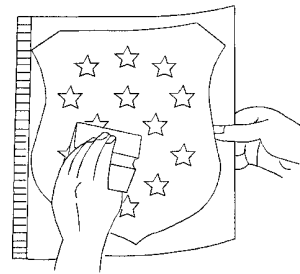

FO9603-33

Figure 7-6. Applying Large Emblems (Step 4)

**7.3 LARGE EMBLEMS AND LETTERS USING HINGE APPLICATION METHOD.**

Apply these decals using a “Hinge” method as outlined below.

- a. Tape decal into position with small pieces of masking tape (See Figure 7-3) as step 1.
- b. Apply 1 inch or 2 inches wide tape over one edge to serve as a hinge. Whenever possible, hinge narrow edge. (See Figure 7-4). If the surface requires that the longer edge be hinged, it may be necessary to use the carrier method. Bending the decal back at the hinge, peel the liner off of the decal. For large decals, it may be more convenient to peel the liner back a few inches at a time as the application progresses. (See Figure 7-5.) - Steps 2 and 3.
- c. Hinge back and squeegee or roll the emblem to surface with firm, overlapping strokes. Hold sheeting away from

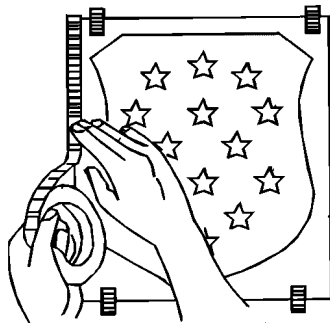

FO9603-31

Figure 7-4. Applying Large Emblems (Step 2)

the surface with one hand and allow adhesive to touch only as pressure is applied. Be sure the edges are firmly adhered. (See Figure 7-6.) - Step 4.

#### 7.4 DECALS APPLIED USING APPLICATION TAPE.

This method is particularly useful with large or intricately shaped emblems or for hot weather applications. Steps 1, 2, and 3 under Figure 7-7, Figure 7-8, and Figure 7-9 are not necessary when decals are supplied premasked (cut to same shape as decal with application tape).

- Place a piece of application tape with the adhesive side up on a flat, rigid surface. (See Figure 7-7.)
- Align emblem or letter with film side down and drop onto the adhesive. (See Figure 7-8.)
- Starting in the middle of the decal, squeegee to application tape with firm strokes of the plastic squeegee. (See Figure 7-9.)
- Tape into position and follow application steps under hinge method.
- Remove tape by pulling directly back upon itself at 180°. Re-squeegee decal, especially the edges. (See Figure 7-10.)

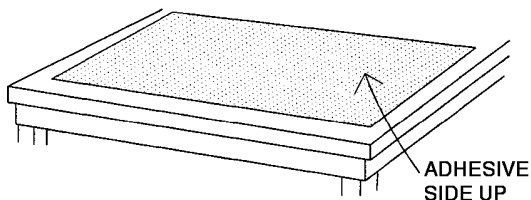

FO9603-34

**Figure 7-7. Use of Application Tape (Step 1)**

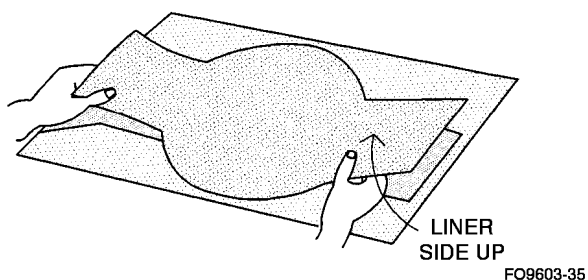

FO9603-35

**Figure 7-8. Use of Application Tape (Step 2)**

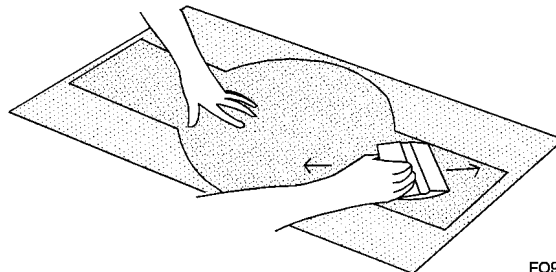

FO9603-36

**Figure 7-9. Use of Application Tape (Step 3)**

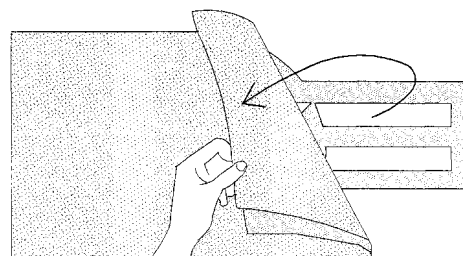

FO9603-37

**Figure 7-10. Use of Application Tape (Step 4)**

#### 7.5 EDGE SEALING.

Seal all edges of decals applied over the topcoat on the exterior of the aircraft. Decals that have been applied pre-masked over primer coat and subsequently top coated do not require edge sealing.

#### NOTE

Seal decal edges when required with 3M Co. (Cage Code 34360) Edge Sealer, PN 4150 under NSN 8030-00-195-7660, or PN 3950 under NSN 8030-00-936-9940. Use of other edge sealers will cause early failure of 4000 series decal ink and A-A-59485 polyester film decals.

- Use the felt wick applicator attached to screw top can or use small narrow striping brush.
- Apply sufficient sealer to effect a feather edging along the entire decal edge. (See Figure 7-11).



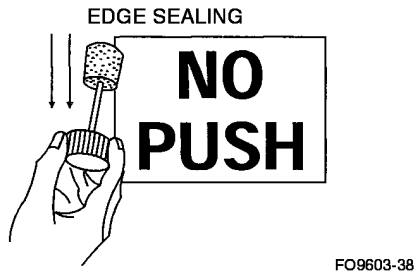

**Figure 7-11. Edge Sealing**

## 7.6 APPLICATION OF PREMASKED DECALS.

Decals that have application tape (cut to the same shape as the decal) applied to the film side are supplied specifically for application on the primer coat (MIL-PRF-23377, MIL-PRF-85582, or TT-P-2760 only).

- Tape the decal into position and follow application steps under “hinge method”. (Paragraph 7.3.)
- After the paint topcoat has cured, remove the masking in the same manner shown in Figure 7-10 except do not re-squeegee.

## 7.7 DECAL REMOVAL.

### WARNING

MIL-T-81772 thinner is flammable and toxic. Keep away from heat and open flame. Keep container closed when not in use. Use only with adequate ventilation. Avoid prolonged or repeated contact with skin. Avoid swallowing.

Remove perforated decals, listed in Chapter 2, conforming to A-A-59845, Type I, with paint remover. The film is a highly solvent resistant polyester, so the paint remover must penetrate through the perforations to soften the adhesive. It may be necessary to use repeated applications of remover to remove the film from adhesive. Another application of remover on the adhesive may then be required. Scrape off the bulk of the softened adhesive with a non-metallic scraper. Wipe off any remaining adhesive residue with thinner conforming to MIL-T-81772 on a cotton cloth. Non-perforated A-A-59845 type film can only be removed by applying steam or dry heat to the decal and physically removing film. Wipe off any remaining adhesive with thinner conforming to MIL-T-81772 on a cotton cloth.

## 7.8 APPLICATION OF MARKINGS WITH SILK-SCREEN.

This method can be used for painting internal and external markings and insignias.

### 7.8.1 Materials and Equipment for Silkscreening.

#### Equipment:

Locally fabricated or commercially procured silk-screens are both authorized. Screen should be polyester monofilament (220-280 mesh).

Silkscreen, squeegee, commercially procured.

#### Materials:

Colored marking paint, MIL-PRF-81352, Type I - Acrylic, Type II - Alkyd, Type III - Polyurethane.

Thinner, MIL-T-81772, Type I and III.

Topcoat, MIL-PRF-81352, Type I, II, or III, clear.

## 7.9 SURFACE PREPARATION.

Prior to silk-screening, wipe area being marked with one of the ketones or non-terpene solvent blends in Table 3-2. Freshly painted surfaces require no cleaning.

**7.9.1 Application.** Mount the silkscreen securely on the aircraft or equipment being marked.

### WARNING

MIL-PRF-81352 Types I, II, or III are flammable and toxic to eyes, skin, and respiratory tract. Eye and skin protection required. Good general ventilation is normally adequate.

### NOTE

- The silkscreen paint being used may be either acrylic, alkyd, or polyurethane, unless otherwise specified in the system specific technical order.
  - If the silkscreened marking requires a clear topcoat, ensure it is compatible with the silkscreen and the base paint materials.
- Place just enough paint on the top of the silkscreen, just above the design to completely cover the design when drawn. Using a square edge squeegee, draw the paint across the silkscreen design using firm constant pressure. When complete, remove the screen from equipment.
  - Clean screen, squeegee and other equipment using applicable thinner.

**7.9.2 Topcoat Application.** Silkscreened markings applied over a basecoat of MIL-PRF-85285, Type I, polyurethane paint may also have a topcoat of clear MIL-PRF-85285 polyurethane, applied using an air spray gun, to improve the abrasion resistance of the silkscreen design. To avoid blurring of the silkscreen ink, apply a light coat of the clear polyurethane initially. Follow with heavier coats and allow to cure dust-free.

## 7.10 APPLICATION OF MARKINGS USING STENCILS.

This method can be used for painting internal and external markings and insignias. The use of locally fabricated or commercially procured stencils are authorized. Use of stencils cut from a vinyl material on a computerized stencil machine are preferable.

7.10.1 Surface Preparation. Prior to stenciling, wipe area to be stenciled with one of the ketones or non-terpene solvent blends in Table 3-2. Freshly painted surfaces require no cleaning.

7.10.2 Mounting Stencil. Stencil may be taped into position using MIL-T-21595/SAE AMS-T-21595, Type 2,

Masking Tape or alternatively use 3M Co. (Cage Code 34360) Repositionable Spray Adhesive 75, PN 3M-75. This adhesive will securely hold the stencil but will not leave any residue when removed. The adhesive is sprayed on the back of the stencil prior to mounting and will remain tacky enough to be reused several times. For the vinyl stencil mask material cut on the computerized Stencil machine, peel the protective backing off the self adhesive side, mount on the surface being marked, remove the cut out sections, and make sure all edges are adhering to the surface. This stencil mask material is easily peeled off the surface after stenciling and leaves no residue.

7.10.3 Painting of Stencils. Stencils shall be applied by using spray, brush or roller application methods. Use the same type of paint as the topcoat.



## CHAPTER 8

### EXTERIOR FINISHES, INSIGNIA AND MARKINGS, APPLICABLE TO USAF AIRCRAFT

#### 8.1 GENERAL.

**8.1.1 Purpose.** The purpose of this chapter is to standardize the painting and marking and exterior configuration of all Air Force, Air Force Reserve and Air National Guard aircraft. This chapter describes Air Force policy on the painting, marking, and exterior configuration of aircraft. Also described in this chapter are common internal markings and standardized international markings. In the event of a technical conflict between this chapter and the weapon system specific manuals shall take precedence. Conflicts concerning safety, health or environmental issues shall be resolved locally and through the MAJCOM headquarters. Only the types of finishes and insignia described in this chapter shall be applied to USAF aircraft. Refer to AFI 21-105 with MAJCOM supplements, weapon system manuals and weapon system drawings for specific paint schemes and marking applications.

**8.1.2 Responsibilities.** 542 SEVSG/GBZAB is responsible for keeping this chapter current. HQ USAF/ILMM is responsible for coordinating Air Force painting and marking policy with the various international organizations and is the focal point for all Air Force painting and marking issues. The MAJCOM logistics and maintenance function is responsible for implementing the policy as described by USAF/ILMM. System Program Directors (SPD) are responsible for maintaining accurate technical data depicting approved paint schemes and markings for their assigned aircraft. SPDs shall be responsible for assuring compliance with AFI 21-105 and Air Force policy promulgated by USAF/ILMM.

**8.1.3 Maintenance and Application.** The MAJCOMs and using organizations are responsible for the application and maintenance of coatings and markings for all assigned aircraft listed in TO 00-25-4. AFMC shall be responsible for the overcoating or strip and repaint of aircraft listed in TO 00-25-4.

**8.1.4 Major Command Instructions.** Each major command shall prepare a supplement for AFI 21-105 pertaining to painting and marking of aircraft. The supplement will be limited to distinguishing insignia, markings and finishes as authorized in this chapter and other Air Force directives.

**8.1.5 Authorized Deviations.** All requests for deviations from the standard exterior paint and marking configuration in this TO will be sent to HQ USAF/ILMM. HQ

USAF/ILMM will coordinate with HQ USAF/XO and maintain copies of drawings and photographs.

**8.1.6 Paint Scheme and Marking Approval Process.** All changes to approved schemes and markings will be submitted to the MAJCOM Aircraft Structural Manager/Corrosion Manager. The ASM/CM will coordinate the changes within the command structure and ensure survivability analysis is completed as necessary. The ASM/CM will work with the SPD to ensure the applicable technical documents are changed and develop a method to implement the changes. A copy of the approved change package will be forwarded to HQ USAF/ILMM. USAF/ILMM will acknowledge receipt of the package and will retain the authority to require changes to the package. Exceptions are as follows:

**8.1.7 89th AW, 201AS, and the 1st Helicopter Squadron.** Deviations from standard paint schemes and markings are authorized and shall be approved by HQ USAF/ILMM.

**8.1.8 U.S. Air Force Aerial Demonstration Squadron "The Thunderbirds".** Paint schemes and markings shall be approved by HQ USAF/ILMM.

**8.1.9 76TH Airlift Squadron.** Aircraft assigned are authorized radio call numbers on each side of the vertical stabilizer, American flag and United States of America markings with no other external USAF markings authorized (i.e. USAF, stars and bars, organizational markings, fuel grade markings under pilot's window) Painting and marking of these aircraft will be as specified by USAFE/CC. Information copies of all approved paint schemes and markings will be forwarded to HQ USAF/ILMM.

**8.1.10 Low Observable Aircraft.** HQ ACC is responsible for developing paint schemes and markings for LO aircraft.

**8.1.11 Aircraft Received From Other Services.** When types and models of aircraft not previously in the Air Force inventory are acquired from other military departments the MAJCOM and SPD will develop paint schemes and markings patterns for the aircraft. The SPD will be responsible for developing special purpose markings for servicing and personnel safety.

8.1.12 Service Tests. Approved service test programs will be implemented by coordinated effort, monitored by the appropriate engineering function, SPD, AFRL, and the requesting MAJCOM.

8.1.13 Decals. Decals are special prepared film containing design, words, letters, or numerals and are intended to be permanently affixed to the aircraft. Decals may be used in lieu of paint for all external markings and insignia where the contact surfaces are of sufficient smoothness to permit good adhesion. Decals shall meet A-A-59484 or commercial equivalent.

8.1.14 Applicable References. The application of North Atlantic Treaty Organization (NATO) code numbers cited in TO 42B1-1-15 shall supplement the applicable service points prescribed in this technical order. The codes will be applied immediately adjacent to the symbol as considered most practical. NATO code numbers may be omitted when not reflected in TO 42B1-1-15 or may be omitted on training type aircraft and other aircraft not subject to being serviced at overseas location. Additional instructions and directives applicable or allied to the application and maintenance of the finishes and markings of aircraft are contained in the following:

CENTO STANAG #3230	Emergency Marking on Aircraft.
NATO STANAG #3109	Servicing and Ground Handling Codes.
NATO STANAG #3230	Emergency Marking on Aircraft.

**8.2 STANDARD EXTERIOR FINISHES MARKINGS AND INSIGNIA FOR USAF AIRCRAFT.**

Standard finishes are applied as either glossy or camouflage topcoats. All topcoats, painted markings and painted insignia will be applied using high-solid polyurethane, MIL-PRF-85285.

8.2.1 Metal Exterior Finishes. Metal exterior finishes other than titanium and CRES require surface protection from corrosive elements and therefore will be painted.

8.2.2 Titanium and Corrosion Resistant Steel. These materials usually make up a small portion of the exterior surface. Titanium and CRES will be painted to match the rest of the exterior of the aircraft providing temperatures permit.

8.2.3 Treatment of Metal Exteriors. Treatment of metal exteriors and corrosion control are specified in TO 1-1-691, and weapon system specific manuals.

8.2.4 Policy Guidance. It is a general policy that all Air Force aircraft will be painted equally as a prime means of

corrosion protection and prevention, appearance and survivability. Painting for professional appearance is an integral part of a well-managed corrosion control program (AFI 21-105). The requirement to paint must be tempered with good judgment. Mission requirements, environmental concerns and resources must be considered prior to painting. Aircraft will be painted in accordance with a service life program. A coordinated paint/depaint program will be established and kept current for each weapon system. Where possible a scoring system should be used to determine painting requirements. The scoring system should account for paint condition, local corrosion severity index (refer to TO 1-1-691) and calendar time. The MAJCOM and SPD will determine when an aircraft is to be stripped and repainted. Maintenance painting will be used to enhance and preserve coating systems.

8.2.4.1 In determining the requirements for sectional overcoating, total overcoating, or strip and repaint, the following general technical criteria should be considered in the development of the weapon system paint plan.

- a. Sectional or total overcoat if the paint is oxidized, discolored, stained, chipped, scratched, or peeled from the primer and the primer remains adhered to the aircraft surface. If the condition is extensive consider a total overcoat.
- b. Strip and repaint if the following defects or combination of defects exists; areas which have been overcoated (primer plus topcoat) at least three times, primer is not adhering to the substrate, or the paint system is peeled to the substrate.

8.2.4.2 When applying the above criteria to determine painting requirements and a combination of defects for strip and overcoating exists, the following general economic guidelines should be considered in the development of the weapon system paint plan.

- a. When determining sectional or total overcoat and a combination of defects exist, overcoating may be accomplished if the time or manhour requirements for surface preparation (mask, sand or clean) do not exceed 70% of the time or man-hours for a complete strip/repaint.
- b. Sectional stripping may be required as determined by deteriorated areas, on aircraft designated for complete overcoat. Complete overcoating may be accomplished if the combined time or man-hours for sectional stripping and surface preparation for overcoat do not exceed 70% of the time or man-hours required for complete strip/repaint.
- c. Complete strip/repaint should be accomplished in lieu of overcoating whenever the time or man-hours for masking, sanding and cleaning for the total or sectional overcoating exceed 70% of those to accomplish strip/repaint.



8.2.4.3 In the absence of a tailored weapon system paint plan the above criteria will apply to all aircraft.

8.2.5 Camouflage. Camouflage is used for the purpose of deception, to conceal material from undesired observation, or to confuse and mislead observers as to the identity and number of assets available. Camouflage may be either pattern or non-pattern. Pattern camouflaging is based on optical principals that dictate certain non-reflective colors, color configurations and color portions. Arbitrary application of markings and color schemes other than those approved will defeat the purpose of the camouflage and is not authorized.

8.2.6 Special Purpose Exterior Solar Resistant Finishes. For the purpose of this manual, solar resistant finish is defined as a white cap painted on the top surface of the aircraft to reduce interior temperature. The solar resistant finish is only authorized on aircraft used primarily as troop carriers or those that carry heat sensitive equipment. In either case the MAJCOM supplement to AFI 21-105 or equivalent MAJCOM instruction will authorize the application of a solar resistant finish.

8.2.7 Paint Facility/Finish Identification Block. (See Figure B-4) All aircraft receiving a new paint finish will have a contrasting color or black (color 37038) block of approximately 2 1/2 inches to 4 inches applied to the right side fuselage on the underside even with the leading edge of the horizontal stabilizer or wing by the activity that applied the paint. Stencils or decals may be used for the paint block. The block will contain:

- The name of the activity, plus the Cage code.
- Date of completion (DD, MMM, YY)
- Identification by specification of all coatings used.
- For non-standard or unique coatings, such as Advance Performance Coating (APC)/Extended Life Topcoat (ELT), add manufacture product code.

#### **NOTE**

All full scuff-sanded and overcoated aircraft require an additional paint identification block for each coating system applied (in addition to the original paint identification block). It shall contain the same information as required in Paragraph 8.2.7 and will be placed adjacent to the original paint identification block.

### 8.3 MARKINGS AND INSIGNIA FOR USAF AIRCRAFT.

8.3.1 General. The markings and insignia contained in the manual will be applied to all USAF aircraft. Markings and

insignia will vary depending on the paint system being applied and the MAJCOM to which the aircraft is assigned. Standard Markings are as listed in Table 8-1. The above standard insignia and markings will not be altered in location, dimension, or configuration to accommodate any other insignia or marking.

8.3.1.1 National Star Insignia. The National Star will be installed on all aircraft. Specific instructions for installing the National Star and approximate dimensions are shown in Figure B-1, and in Paragraph 8.3.1.3.

8.3.1.2 The National Star Insignia on Aircraft Fuselage. The star insignia will normally be applied to the aircraft fuselage midway between the wing trailing edge and the leading edge of the horizontal stabilizer.

8.3.1.3 The National Star Insignia on Aircraft Wings. The star will be applied to the upper surface of the left wing and the lower surface of the right wing. (See Figure B-2)

8.3.1.4 The National Star Insignia on Helicopters. The star shall be applied on the fuselage. The insignia shall be located so that it is visible from each side, above and below. Because of helicopter design configuration the insignia shall be located so as to provide maximum identification. Such locations shall be standardized on like MDS helicopters.

8.3.2 "USAF" Marking. The USAF marking shall be applied to the lower surface of the left wing and upper surface of the right wing. The height and location of the USAF will correspond with the National Star insignia. The letters shall be towards the leading edge of the wing.

8.3.3 American Flag Marking. The display of the American Flag on aircraft exteriors is intended for specific uses, which have national significance or U.S. diplomatic connotations. The use of the flag will be restricted and approved only by HQ USAF/ILMM. Routine or occasional overseas flight of aircraft, assignment of aircraft to foreign soil, or intra-theater travel of overseas based aircraft are not sufficient reasons for use of the American Flag marking. The National Star insignia and USAF markings painted upon aircraft exteriors will adequately identify USAF aircraft. Table 8-2 lists all aircraft authorized the American Flag marking.

**Table 8-1. Standard Markings**

Item	General Location
National Star Insignia	Aircraft Wing and Fuselage
“USAF” Marking	Aircraft Wings
“U.S. AIR FORCE” Marking	Aircraft Fuselage
Serial Number	Aircraft Fuselage
Aircraft Radio Call Number	Aircraft Vertical Fin
American Flag	Aircraft Vertical Fin

**Table 8-2. Aircraft Authorized American Flag Markings**

Air Attache MAAG USAF Mission Apollo Range Instrumentation Aircraft, EC-135 (AFMC-ARIA) and NKC-135A S/N 53-3132 (BIG CROW) 89th Airlift Wing/201AS Air Force Section Mission (U.S. Military Group Aircraft in Latin America) AMC/ACC Airlift Forces Aircraft 76th Airlift Squadron USAFE AFRC and ANG Airlift Aircraft for which ACC/AMC are the Gaining Command EC/RC-135 E-4 Aircraft All Transport and Tanker Aircraft
---

8.3.3.1 The American Flag shall have a height, width ratio of 0.52 to 1, and be located on each side of the vertical fin above all other markings of significance. The flag shall be positioned horizontally such that the union shall be uppermost with the bars appearing to be trailing at all times. (See Figure B-5)

8.3.3.2 The flag or emblem of other countries/(non-Air Force) organizations shall not be displayed on USAF aircraft for any reason.

8.3.4 United States of America Marking. The words “UNITED STATES OF AMERICA” are authorized to be painted on the fuselage exteriors of the following aircraft authorized the American Flag. Table 8-3 list the aircraft authorized “UNITED STATES OF AMERICA”.

8.3.4.1 When authorized, the marking “UNITED STATES OF AMERICA” will be applied on both sides of the aircraft fuselage, parallel to and above the top of the cabin windows. (See Figure B-5) The fuselage marking “U.S. AIR FORCE” shall be removed from the aircraft.

8.3.5 Aircraft Radio Call Numbers. The radio call number will be applied to each side of the vertical stabilizer.

On aircraft with multiple vertical stabilizers the radio call number will be applied to the outboard side of the outer most vertical stabilizer. AMC and ACC each use a different method to mark the vertical stabilizer with the radio call number.

8.3.6 AMC Standard Radio Call Numbers. The radio call number consists of five numbers usually derived from the aircraft serial number. The first numeral of the contract number and the hyphen will not be used (e.g., S/N 63-545134A will be 35134 and 62-3467 will be 23467). (See Figure B-5)

**Table 8-3. Aircraft Authorized United States of America Markings**

Air Attache MAAG AFMC-ARIA USAF Mission 89th Airlift Wing Air Force Section Mission (U.S. Military Group Aircraft in Latin America)
--

**Table 8-3. Aircraft Authorized United States of America Markings - Continued**

76th Airlift Squadron USAFE E-4 Aircraft
---

8.3.6.1 In the event five numerals are not available the radio call number will include the second numeral of the contract year followed by a sufficient number of zeros to provide five numerals (e.g., serial number 73-23A will become 30023).

8.3.6.2 All radio call number placards within the aircraft, including helicopters, shall reflect the same radio call number as applied to the aircraft exterior.

8.3.7 ACC Standard Radio Call Numbers. ACC uses a distinctive two place alphanumeric in conjunction with the first two and last three numbers of the aircraft serial number. When duplicate last three digits exist among aircraft with the same distinctive unit designator, the last four numerals of the serial number shall be used. (See Figure B-6)

8.3.7.1 Distinctive Unit Identifiers. The identifier is two numbers, two letters or one number and one letter. Any MAJCOM may authorize the use of the identifier. HQ ACC will be the approving authority and maintain a registry of the identifiers. When the identifiers are no longer required the respective command will notify HQ ACC. Distinctive identifiers shall not be removed or installed without the expressed knowledge and approval of HQ ACC. Similarly, only ACC may authorize changes in the identification code assignments.

#### 8.4 ORGANIZATION INSIGNIA OR EMBLEMS.

All proposed organizational emblems and insignia will be in accordance with the MAJCOM supplement to AFI 21-105 or equivalent MAJCOM instruction. The MAJCOM or ANG will be the approving authority for these insignia and emblems. Only ANG aircraft are authorized the state name and ANG Minuteman emblem. Application location and size will be in accordance to the MAJCOM supplement to AFI 21-105 or equivalent MAJCOM instruction. Standard markings/insignia shall not be altered to accommodate any organizational markings/insignia. When the aircraft is being transferred the transferring unit will remove its markings and insignia. Aircraft being processed for storage are exempt from the requirement to remove markings/insignia.

8.4.1 Outstanding Unit Award Marking. A replica of the "Outstanding Unit Award" ribbon earned by an organization may be installed on the sides of the fuselage in accordance with the MAJCOM supplement to AFI 21-105 or equivalent MAJCOM instruction. The marking shall not exceed 12 inches in length. The size ratio shall be 4:1.

8.4.2 Crew Names. The names of the pilot crew chief, or other members of the flight or ground crew shall be applied to the aircraft in accordance with the MAJCOM supplement to the AFI 21-105 or equivalent MAJCOM instruction. The MAJCOMs shall require crew markings be removed prior to deployment to combat zones. Aircraft in combat zones are not authorized to have any crew markings. Names shall be reapplied as soon as practical following redeployment from the combat zone.

8.4.3 Aircraft Names. All requests for applying aircraft names to the exterior of aircraft shall be coordinated through the appropriate MAJCOM/CC and forwarded to HQ USAF for CV approval. Send justification to HQ USAF/ILMM. Information on approved names, colors, sizes, and locations shall be included in the MAJCOM's supplement to AFI 21-105 or equivalent MAJCOM instruction.

8.4.4 Local Station Numbers and Markings. Where aircraft may have a duplication of the last three digits of the aircraft serial number or atmospheric conditions may hinder visibility at a station the MAJCOM may authorize local station numbers.

8.4.4.1 Station Numbers. Station numbers shall be located on the nose section of fixed wing aircraft and on the deflector shields or other forward component of rotor wing aircraft. Numerals will not be more than 8-inches tall and proportionate to the aircraft size. Station numbers shall be removed prior to transfer of the aircraft.

8.4.4.2 Tail Stripe. MAJCOMs may authorize a distinguishing colored horizontal strip for application to both sides of the vertical fin. The stripes shall not be applied over apex antenna.

8.4.5 Propeller Markings. All Air Force propeller blade tips will be painted in a contrasting color. All blades will be checked for balance after application of blade markings. For blades less than 15 feet in diameter (measured from the tip of the blade to the hub center) the stripe will be 4 inches wide. Larger diameter blades will have 6 inch strip.

8.4.5.1 Propeller tips may be marked with light reflective yellow or a contrasting color when it is necessary to define the blade track in the dark.

8.4.5.2 Aircraft whose primary mission is transportation of VIPs are authorized to have red, white, and blue stripes applied to the propeller tips. Approval authority for this marking is the MAJCOM. The occasional transport of VIPs in not sufficient justification for multi-colored blade tips. Each blade will be painted red, white, and blue in this order with red being the color closest to the blade tip. For blades 15 feet in diameter and less each stripe will be 1 1/2 inches wide. Larger diameter blades will have a 2 inch stripe. Table 8-4 lists aircraft authorized multicolored blade tips.

**Table 8-4. Aircraft Authorized Multi-Colored Blade Tip Markings**

Air Attache MAAG USAF Mission 89th Airlift Wing
--

**8.4.6 Helicopter Main Rotor Blade Markings.** Classification numbers shall be stenciled on the inboard (butt end), flat surface of the ground side of each main rotor blade by facilities authorized to balance and alter the rotor blades. Three numbers in decimal format shall be utilized: the first shall be weight in pounds; the second shall reflect the distance in inches from the center of rotation to the center of gravity of the blade; and the third number shall be the distance in inches from the leading edge of blade to the center of gravity for the blade chord-wise. (e.g., 57.2-75.2-5.2 indicates the blade weighs 57.2 pounds, with a center of gravity 75.2 inches from the center of rotation and chord-wise center of gravity is 5.2 inches from the leading edge.) Contrasting coloring stenciling shall be 3/4 inch in height. Color bands installed by the contractor on the tip of the blade shall be maintained along with matching colors on the housing. Different colors are required on the blades for tracking purposes.

**8.4.7 Helicopter Tail Rotor Blade Markings.** To promote safety all tail rotor blades except Sikorsky blades utilizing B and B bonding or having vinyl plastic tape installed shall be marked using MIL-PRF-85285 and a compatible primer coat as follows:

- a. Prime surface with a light coat of primer.
- b. Apply a 6 inch band of red (color 31136) to the tail rotor tip followed by a 6 inch band of white (color 37925) followed by another 6 inch band of red (color 31136).
- c. Following the second band of red apply a black band (color 37038) to within 6 inches of the hub. Paint the remaining 6 inches of the tail rotor red (color 31136).
- d. Identifying color bands painted by the contractor shall be maintained and an identifying dot, approximately 1/2 inch in diameter, of the same color as appears on the housing shall be painted on the butt end of the blade for matching purposes.
- e. Balance the blades as necessary.

**8.4.8 Identification Markings of Jettisonable Aircraft Components.** All jettisonable components will be stenciled using MIL-PRF-85285. The color will be selected to provide the greatest contrast with the surrounding base color of the component.

**8.4.8.1 Canopies.** The radio call number shall be stenciled in 1 inch letters 6 inches from the forward left-hand end, on either the inside or outside of the canopy frame.

**8.4.8.2 Ejection Seats.** All ejection seats shall have the radio call number stenciled on the seat back near the top edge. If the aircraft is equipped with more than one seat the flight crew position (i.e. pilot, NAV, GUNNER, and etc.) shall be stenciled under the radio call number. The numbers and letters shall be 1 inch high and positioned to avoid contact with parachute gear.

**8.4.8.3 Jettisonable Components.** Where jettisonable components such as external tanks are interchangeable and are frequently removed, and create a problem of stockpiling components for a specific aircraft, the base supply account number contained in AFMAN 23-110 will be applied to the component. The stencil will be 1 inch high and applied near the component center on both sides.

**8.4.9 Markings for Servicing, Ground Handling and Hazard Warning.** (See figures B-7 through B-13) The markings shall be in contrasting colors. Lettering shall be in accordance with the Appendix B. Symbols for the identification of service points, ground handling, and hazard warnings shall be applied to the required locations on all USAF aircraft. Location is dependent on the amount of available space. The marking may be on or adjacent to the equipment or service point. Symbols and markings may be applied using paint or decals. Symbols shall be approximately 4 inches in size but maybe smaller depending on the area or item being marked. The markings provide:

- Rapid identification of servicing points.
- Identification of the type of ground servicing required.
- Hazard warning or safety precautions, which will prevent injury to personnel or damage to equipment.
- Rapid exit from air vehicle under emergency conditions.

**8.4.10 Markings for Engine Compartment Fire Access Panel.** The fire access panel or doors in the engine compartments shall have contrasting color boarder and identifying text.

**8.4.11 Ejection Seats.** A contrasting color equilateral triangle with the sides up to nine inches long, with the apex pointing downward shall be applied on each side of the fuselage adjacent to the explosive device.

**8.4.12 Identification of Ballistic Hose Assemblies.** Ballistic hose or tubing assemblies leading to the ejection seat or catapults shall be marked for ground rescue purposes. The area selected shall be easily visible and readily accessible and as close as possible to the catapult (see appendix B).



**8.4.13 Markings for Tank Filler Areas.** Fuel filler caps shall be painted red. A red band, one inch wide, around and two inches away from the fuel fill cap or over the cover door is optional.

**8.4.14 Marking of Emergency Lighting (Flashlight) for Cargo & Transport Aircraft.** Aircraft which have flashlights adjacent to natural or emergency exits will have a 1/2 inch yellow band around the base of the flashlight mount. The band may be applied to the sides of the light holder if the material cannot be applied around the base. The band may be formed from 3M retro reflective or 6900 photo luminescent paint (TT-P-54), or reflection tape (ASTM D4956).

**8.4.15 Markings for Walkways and Steps.** In cases where walkways don't contrast with surrounding areas, the walkway will be bounded by a contrasting color line. The word "WALKWAY" shall be stenciled at sufficient intervals. Steps areas shall be indicated at all point on the aircraft.

**8.4.16 Markings for Composite/Honeycomb Panels.** Composite or honeycomb panels on upper surfaces shall be distinctly marked by contrasting color 1 1/2 inch wide hash marks. Each hash mark shall be 2 inches long and separated by 2 inches. The marks shall slope 45 degrees.

#### **8.4.17 Removable Escape Panels.**

**8.4.17.1 Internal Markings.** Marking for the identification of escape hatches, doors, and exits on the interior of the aircraft shall be painted orange-yellow (color 13538). Use black (color 17038) on yellow surfaces. Use MIL-PRF-85285, 3M retro reflective or 6900 photo luminescent paint (TT-P-54), or reflection tape (ASTM D4956).

- a. Apply an intermittent band to mark the periphery of the personnel escape exit. The segments of the band will have a minimum width of 1 inch and a length of 2 inches, divided equally, possible and practical between the door mounting and the escape door itself. Where the lining will cover the identification marking band inside of the aircraft, continue the marking onto the lining.
- b. The words EMERGENCY EXIT, shall be applied on the escape hatch door or exit or any covering thereof in the most readily visible location. Letters should be approximately 2 inches high.
- c. Paint handles, releases, catches, and knobs for inside hatches and exit doors. Where lettering or marking areas are covered by lining, the lining shall also be appropriately marked. Suitable descriptive wording, readily visible, shall be applied to the door or structure of the aircraft, whichever is neared the emergency release, to identify and explain its operation. This wording should be approximately 1-inch high. Use Standard English terminology such as PULL, TURN, SLIDE, or PUSH.

**8.4.17.2 External Markings.** Markings for the identification of escape hatches, doors, and exits on the exterior of

the aircraft shall be painted orange-yellow (color 13538) or a contrasting color. Use MIL-PRF-85285. The words EMT RELEASE, shall be applied on the outside of the aircraft to facilitate quick identification. Suitable descriptive wording shall be applied to the door or structure of the aircraft, whichever is neared the emergency release, to identify and explain its operation. This wording should be approximately 1-inch high. Use Standard English terminology such as PULL, TURN, SLIDE, or PUSH. Letters should be approximately 2 inches high.

#### **8.4.18 Markings for Unmanned aerial Vehicles.**

**8.4.18.1 Target Drones.** Target drones for crew training, weapons evaluation and etc., shall be painted International Orange (color 12197) using MIL-PRF-85285.

**8.4.18.2 Other Unmanned Aerial Vehicles.** All other UAVs, RPVs, and drones may be painted with a color scheme to suit the mission requirement. The schemes and markings shall be approved in accordance with the MAJCOM supplement to AFI 21-105. MIL-PRF-85285 shall be the standard topcoat.

**8.4.19 Conspicuity Markings.** Conspicuity Markings (MIL-PRF-85285, color 12197) may be used under special conditions on non-camouflaged aircraft and are intended to enhance air-to-air visual detection for safety purposes. Conspicuity markings will be approved by HQ USAF/ILMM for aircraft engaged in special missions.

#### **8.4.19.1 Aircraft required to have conspicuity markings:**

- Aircraft used primarily as target
- Aircraft specifically designated by the MAJCOM due to special requirements of research and development. Included may be director and drone aircraft.
- Special conspicuity markings are authorized only when 75% or more of the mission flying hours are utilized enroute/on facility time.

**8.4.20 Arctic Markings.** The use of arctic markings (MIL-PRF-85285, color 12197) is intended to facilitate the location of aircraft downed in regions covered by ice and snow.

**8.4.20.1 Arctic Marking Exemptions.** Aircraft in the following categories are exempt from compliance with arctic markings:

- Air Attache.
- Aircraft scheduled for short periods of duty less than 180 days) in Arctic or Antarctic regions.
- Active strike force and combat support aircraft assigned offensive missions for less than 180 days in Arctic or Antarctic regions.

**TO 1-1-8**

**8.5 ESTABLISHING REQUIREMENTS FOR MISSION  
ACTIVITY, CREW ACCOMPLISHMENT, AND ESPRIT  
DE CORPS INSIGNIA AND MARKINGS.**

final approval of the senior logistics official in each MAJ-COM. A copy of all approved markings should be forwarded to HQ USAF/ILMM.

Markings which reflect mission activity, crew accomplishment and esprit de corps are allowed at the discretion and



## APPENDIX A

### SHELF-LIFE EXTENSION PROCEDURES

#### A.1 GENERAL TESTING PROCEDURES.

WR-ALC/MXRILC is the AF executive agent for the Shelf-Life Extension Data (SLED) program, reference AFMAN 23-110. Under their authority the following test procedures are provided for the testing of the most commonly used coatings in this technical order under the 8010 NSC.

- a. These procedures are authorized for use to supplement the test requirements of AFMAN 23-110 and the SLED program for MIL-PRF-23377, TT-P-2760, MIL-PRF-85582, and MIL-PRF-85285. When any of the above materials have reached their established shelf-life they must be tested per the requirements of AFMAN 23-110 at AFMC Laboratories, commercial laboratories or at bases with the means to test these materials using the procedures established here.
- b. The information contained in the SLED program is advisory in nature; however, it may be used to assist in the management of shelf-life extension for MIL-PRF-23377, TT-P-2760, MIL-PRF-85582, MIL-PRF-85285 (and other 80 FSG materials not discussed here, reference AFMAN 23-110). This information may be used to extend the inspection and test date for material under the same NSN and manufacturer's batch and lot number. Additionally, condemning material shall be per the requirements of AFMAN 23-110 or results of testing of local stocks, either by a laboratory or the tests provided here.
- c. Testing shall be accomplished on or before the initial expiration date and on or before each extension expiration date. Shelf-life extensions are for one-half (1/2) the original shelf-life. This is the maximum allowable update for each retest.
- d. To perform base level tests where laboratories are not available or sending the material for laboratory testing is not economically feasible, the following are necessary: an approved paint spray booth, disposable volume measuring containers either fluid ounces or milliliters (these may be available from medical organizations), a powered stirring device of 140 RPM, and either No. 2 Zahn or No. 4 Ford viscosity measuring cup. Each material must be accurately mixed and sprayed on test panels to perform the test. Each coating must be evaluated for its condition in the container, viscosity, pot life, curing (drying) time, and surface appearance.
- e. These materials chemically react when mixed, and they are temperature sensitive. The coating components must always be allowed to warm to room temperature for up

to 24 hours, as necessary. Tests shall not be performed at temperatures below 70° F or above 80° F as the temperature will impact viscosity, pot life and curing time. The components must be mixed accurately. When the manufacturer's instructions are to mix by ratio, such as 3 to 1 (3 parts component A to 1 part component B) and the quantity to be mixed for testing is 16 fluid ounces, mix 12 fluid ounces of part A to 4 fluid ounces of part B. Manufacturer's instructions for mixing ratios of these materials is always by volume and not by weight; therefore, quantities to be measured for mixing can always be determined by using disposable measuring cups.

#### A.2 MIL-PRF-23377 EPOXY PRIMER.

**A.2.1 Condition in the container.** Using a kit of material from each batch or lot number to be tested, allow both components A and B to stand until reaching room temperature, and open each container and examine. Mix each component vigorously by hand (using a paddle) or with a mechanical shaker. Each component shall be capable of being mixed within 5 minutes. Each component shall be smooth, homogenous, and pourable. The material shall be free of grit, skins, seeds, lumps, abnormal thickening, or livering. In addition, it will reincorporate into a smooth, homogeneous state by mixing with a hand paddle without exhibiting pigment floatation or excessive settling. The containers shall not exhibit deformation due to internal pressure.

**A.2.2 Viscosity and Pot Life.** To test the viscosity and pot life, mix an adequate quantity of the primer per the manufacturer's instructions (measuring each component). Check viscosity of the unthinned coating with either a No. 2 Zahn or No. 4 Ford cup for conformance with the maximum viscosity ratings given in Table A-1 at the times specified in the table.

**A.2.3 Drying Time.** Mix an adequate quantity of the coating for spray application of test panels per the manufacturer's instructions (measuring each component), and spray the primer on the test panels. Test panels shall be aluminum measuring approximately 3 in x 6 in. The primer coating shall be set-to-touch (when touched, no material transfers to finger) within five hours, and dry-hard (finger applied with reasonable force and turned with no deformation of coating) within eight hours after spray application.

**A.2.4 Surface Appearance.** When sprayed on a vertical surface to a thickness of 0.0006 to 0.0018 inch, the primer

## TO 1-1-8

coating shall not sag, run, or streak, and shall dry to a smooth, uniform surface free from grit, seeds, craters, blisters, and other irregularities.

### A.3 MIL-PRF-85582 WATERBORNE EPOXY PRIMER.

**A.3.1 Condition in the container.** Using a kit of material from each batch or lot number to be tested, allow to stand until reaching room temperature, and open each container and examine components A and B. Mix each component by hand or mechanical shaker. Each component shall be capable of being mixed within 5 minutes. Each component shall be smooth, homogenous, and pourable. The material shall be free of grit, skins, seeds, lumps, abnormal thickening, or livering. In addition, it will reincorporate into a smooth homogeneous state by mixing with a hand paddle without exhibiting pigment flotation or excessive settling. The containers shall not exhibit deformation due to internal pressure.

**A.3.2 Viscosity and Pot Life.** To test the viscosity and pot life, mix an adequate quantity of the coating per the manufacturer's instructions (measuring each component). Thin the coating as required per the manufacturer's instructions. When the mixed primer is diluted to application viscosity with water, there shall be no evidence of incompatibility and the material shall be suitable for spray application. Measure the viscosity and record the results. Place the mixed coating in container and stir at 140 RPM  $\pm$ 30 RPM for 4 hours. After 4 hours the viscosity shall not increase more than 8 seconds through a No. 4 Ford cup or 9.5 seconds through a No. 2 Zahn cup.

**A.3.3 Drying Time.** Mix an adequate quantity of the coating for spray application of test panels per the manufacturer's instructions (measuring each component), and spray the primer on the test panels. Test panels shall be aluminum measuring approximately 3in x 6in. The primer coating shall be set-to-touch (when touched, no material transfers to finger) within one hour, and dry-hard (finger applied with reasonable force and turned with no deformation of coating) within six hours after spray application.

**A.3.4 Surface Appearance.** When sprayed on a vertical surface, to a thickness of 0.0006 to 0.0018 inch, the primer coating shall not sag, run, or streak, and shall dry to a smooth uniform surface free from grit, seeds, craters, blisters, and other irregularities.

### A.4 TT-P-2760 POLYURETHANE PRIMER.

**A.4.1 Condition in the container.** Using a kit of material from each batch or lot number to be tested, allow to stand until reaching room temperature, and open each container and examine components A and B. Mix each component vigorously by hand (using a paddle) or with a mechanical shaker. Each component shall be capable of being mixed within 5

minutes. Each component shall be smooth, homogenous, and pourable. The material shall be free of grit, skins, seeds, lumps, foreign contaminants, abnormal thickening, or livering. In addition, it will reincorporate into a smooth, homogeneous state by mixing with a hand paddle without exhibiting pigment flotation or excessive settling. The containers shall not exhibit deformation due to internal pressure.

**A.4.2 Viscosity and Pot Life.** To test the viscosity and pot life, mix an adequate quantity of the prime per the manufacturer's instructions (measuring each component). Check viscosity with either a No. 2 Zahn or No. 4 Ford cup for conformance with the maximum viscosity ratings given in Table A-1 at the times specified in the table.

**A.4.3 Drying Time.** Mix an adequate quantity of the coating for spray application of test panels per the manufacturer's instructions (measuring each component), and spray the primer on the test panels. Test panels shall be aluminum measuring approximately 3 in x 6 in. The primer coating shall be set-to-touch (when touched, no material transfers to finger) within five hours, and dry-hard (finger applied with reasonable force and turned with no deformation of coating) within eight hours after spray application.

**A.4.4 Surface Appearance.** When sprayed on a vertical surface to a thickness of 0.0012 to 0.0025 inch, the primer coating shall not sag, run, or streak, and shall dry to a smooth, uniform surface free from grit, seeds, craters, blisters, and other irregularities.

### A.5 MIL-PRF-85285 HIGH SOLIDS POLYURETHANE.

**A.5.1 Condition in the container.** Using a kit of material from each batch or lot number to be tested, allow to stand until reaching room temperature, and open each container and examine component A and B. Mix component A vigorously by hand using a paddle or with a mechanical shaker. It shall mix to be smooth, homogenous, and pourable condition. The material shall be free of grit, seeds, lumps, abnormal thickening, or livering. In addition, it will not show pigment flotation or excessive settling which cannot be easily reincorporated to a smooth, homogenous state. Component B shall be homogeneous, clear, free from gelation or detectable particulate matter either suspended in solution or settled on the inner surface of the container.

**A.5.2 Viscosity and Pot Life.** To test the viscosity and pot life, mix an adequate quantity of the coating per the manufacturer's instructions (measuring each component). Check viscosity with either a No. 2 Zahn or No. 4 Ford cup for conformance with the maximum viscosity ratings given in Table A-1.

**A.5.3 Drying Time.** Mix an adequate quantity of the coating for spray application of test panels per the manufac-

turer's instructions (measuring each component), and spray the coating on the test panels. Test panels shall be aluminum measuring approximately 3 in x 6 in.

**NOTE**

For this coating test panels must be primed with either MIL-PRF-23377 or MIL-PRF-85582 primer applied to a thickness of 0.0006 to 0.0009 inch. The coating shall be set-to-touch (when touched, no material transfers to finger) within four hours, and dry-hard (finger applied with reasonable force and turned with no deformation of coating) within twelve hours after spray application.

A.5.4 Surface Appearance. When sprayed on one vertical and one primed horizontal mounted panel to a thickness of 0.0017 to 0.0023 inch, the coating shall dry to a

smooth, uniform surface free from runs, sags, bubbles, streaks, hazing, seeding, dusting, floating, mottling, or other defects and irregularities.

**A.6 TOUCH-UP PENS.**

(Sempens MIL-PRF-23377/MIL-PRF-85285).

A.6.1 Practical Test. These materials only require a practical test by the user. Prepare the applicator by sliding the tube collar all the way to the back of the applicator. Shake the applicator vigorously by hand until the materials are thoroughly mixed (approximately one minute). Brush material on test surface and determine if it applies evenly. Allow to dry and verify material meets drying time criteria in Paragraph A.2 for MIL-PRF-23377 Epoxy Primer/Paragraph A.5 for MIL-PRF-85285 High Solids Polyurethane. If either practical test fails, dispose of the item.

**Table A-1. Viscosity and Pot Life**

Coating and Primer	Check Time After Mix (Minimum)	Maximum Time	
		No. 4 Ford Cup	No. 2 Zahn Cup
MIL-PRF-23377	Initial	40	48
	4 hours	70	84
TT-P-2760	Initial	30	36
	4 hours (closed container)	60	72
MIL-PRF-85285	Initial	30	36
	4 hours	60	72
Type I	8 hours	shall not gel	shall not gel



## APPENDIX B

### STANDARD AIR FORCE AIRCRAFT MARKINGS

#### B.1 NATIONAL STAR INSIGNIA.

a. Dimensions. (Figure B-1.) The dimensions of the insignia shall be determined by the diameter of the circumscribed circle which is standardized in multiples of 5 inches.

- (1) The width of each end of the rectangle shall equal  $1/2$  the radius of the circle; the length shall equal 1 radius (excluding border).
- (2) The width of the horizontally centered at each end of the rectangle, shall equal  $1/6$  of the radius of the circle (excluding border).
- (3) The width of the insignia outer bar shall equal  $1/8$  the radius of the circle (excluding border).
- (4) Construction of the five pointed star may be accomplished by marking off five equal distant points on the circumscribed circle and connecting each point to the non-adjacent points.

b. National Star Insignia on Aircraft Wings. Each insignia will be positioned at a point inboard from each wing tip equal to  $1/3$  the distance from the wing tip to the wing-fuselage mating point. The border of the insignia will be tangent to the movable control surface cut-out.

- (1) The wing insignia may be moved in the minimum required distance to avoid structures which would alter the insignia pattern. However, symmetry will be maintained with the USAF marking on the opposite wing surface.
- (2) Normally, the wing insignia shall be positioned so that in normal flight attitude the top point of the star points forward and a line through the center of the insignia and the top star point is parallel to the direction of flight.
- (3) On swept wings or wings of variable sweep aircraft, the National Star Insignia shall be positioned as illustrated in Figure B-2. The insignia or any part thereof shall not extend to movable flight control surfaces. The insignia shall be applied so that the line through the center and the top point of the star is perpendicular to the constant 50% chord line of the wing.

(4) The National Star Insignia selected for the wing shall not exceed a maximum diameter of 60 inches nor have a minimum diameter of less than 20 inches (excluding border). The diameter of the circumscribed circle will be the standard size closest to but not exceeding 75% of the distance between the wing leading edge and the moveable surface cut-out at the point of application.

c. National Star Insignia on Aircraft Fuselage. The insignia may be moved forward or aft the minimum distance required to avoid transparent material, or areas exposed to extreme heat or fluids which would scorch, deteriorate or otherwise damage the insignia. The insignia may extend over doors and emergency exits, but the insignia shall not extend over the window areas or other such openings which would change the design of the insignia.

#### NOTE

The insignia will be the standard size closest to, but not exceeding, 75% of the fuselage height at the point of application. The diameter of the blue circle will not exceed 50 inches nor be less than 15 inches. Symmetry will be maintained when applying the insignia on each side of the fuselage.

d. National Star Insignia on Helicopters. The National Star Insignia will be applied on vertical surfaces so that in normal flight attitude the top point of the star points upward; on horizontal surfaces the top point of the star will point forward in the direction of flight.

#### B.2 U.S. AIR FORCE MARKING.

- a. Letter width shall be equal to  $2/3$  the letter height except that the width of the letter "I shall be equal to  $1/6$  of the letter height."
- b. Letter stroke and spaces shall be equal to  $1/6$  the height, except that the space between "period" and "A" shall be  $1/3$  letter height.
- c. The space between AIR and FORCE shall be one letter width.

WHEN REFERENCE IS MADE TO SIZE OF THE INSIGNIA, THE REFERENCE IS TO THE SIZE OF THE BASIC CIRCLE ON WHICH THE WHITE STAR IS CONSTRUCTED, AND NOT TO THE OUTER EDGE OF THE BLUE OUTLINE.

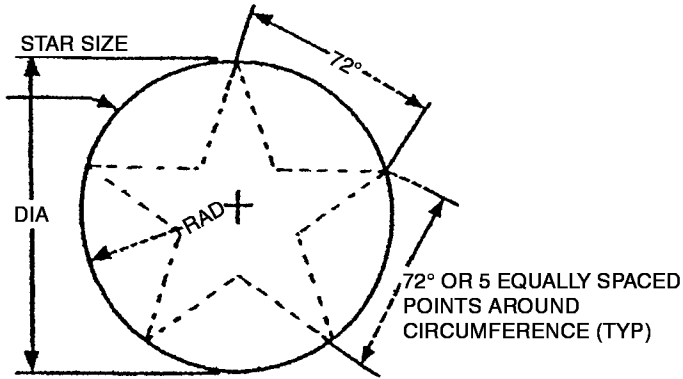

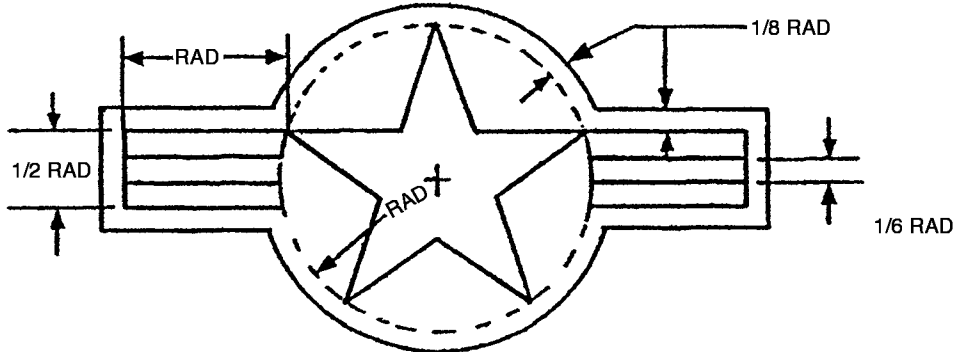

TEMPLATE OR STENCIL LAYOUT

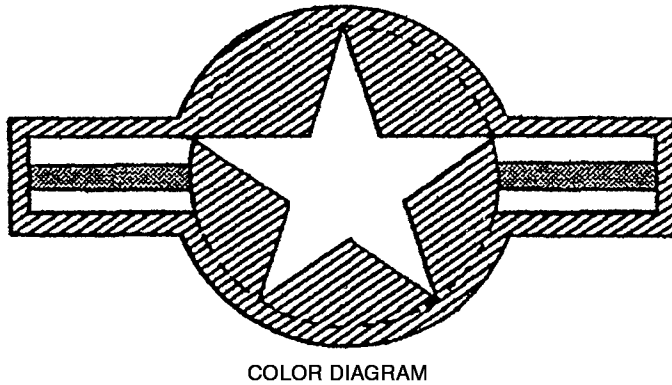

CONSTRUCTION DETAILS



COLOR DIAGRAM

-  INSIGNIA RED
-  INSIGNIA WHITE
-  INSIGNIA BLUE

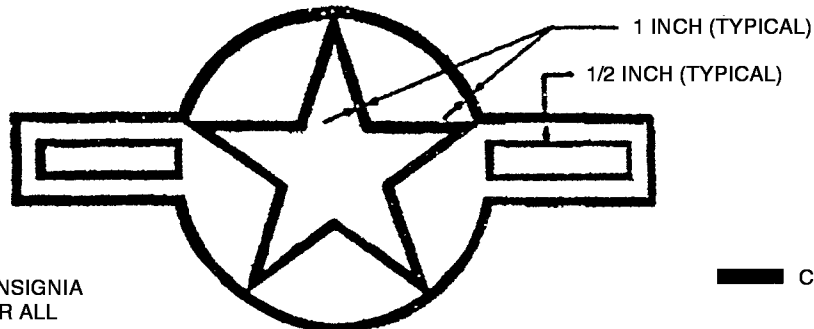

CAMOUFLAGE DIAGRAM

SOLID LINE OF NATIONAL STAR INSIGNIA IS APPROVED FOR ALL USAF AIRCRAFT.

 CONTRASTING COLOR

Figure B-1. Edge Sealing



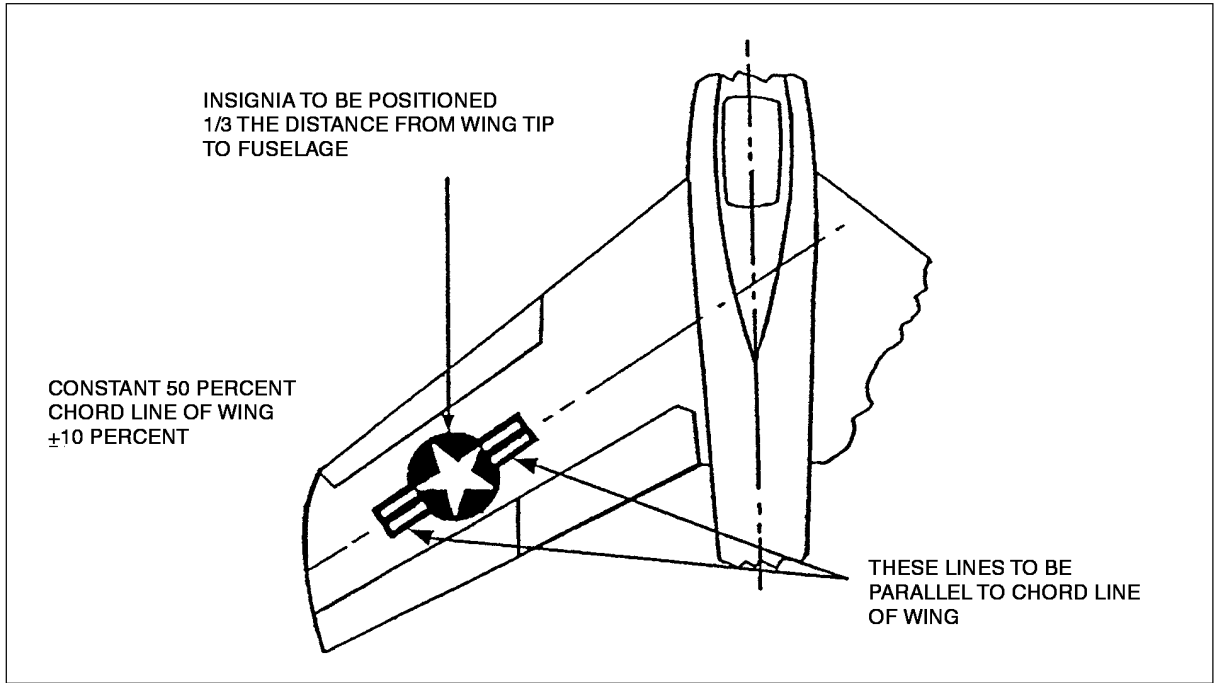

FO9603-40

Figure B-2. National Star Insignia on Swept Wings

# TYPICAL FORM OF LETTERS AND MATERIALS

(SIMILAR COMPUTER GENERATED FONT IS AUTHORIZED)

VERTICAL BLOCK TYPE/  
STYLE FONT/LETTERING/  
ARABIC NUMERALS

A B C D E F G H I J

K L M N O P Q R S

T U V W X Y Z

1 2 3 4 5 6 7 8 9 0

WIDTH OF LETTERS TO BE  $\frac{2}{3}$  OF HEIGHT

WIDTH OF LETTERS "M" AND "W" SAME AS HEIGHT

WIDTH OF LETTER "I" AND NUMERICAL "1" TO BE  $\frac{1}{6}$  OF HEIGHT

STROKE TO BE  $\frac{1}{6}$  OF HEIGHT

SPACE BETWEEN LETTERS AND NUMERALS TO BE  $\frac{1}{6}$  OF HEIGHT

SPACE BETWEEN WORDS TO BE  $\frac{2}{3}$  OF HEIGHT

## VERTICALLY APPLIED LETTERING

SPACE BETWEEN LETTERS AND NUMERALS  $\frac{1}{6}$  HEIGHT

SPACE BETWEEN WORDS SAME AS HEIGHT

FO9603-41

Figure B-3. Form of Letters and Numerals

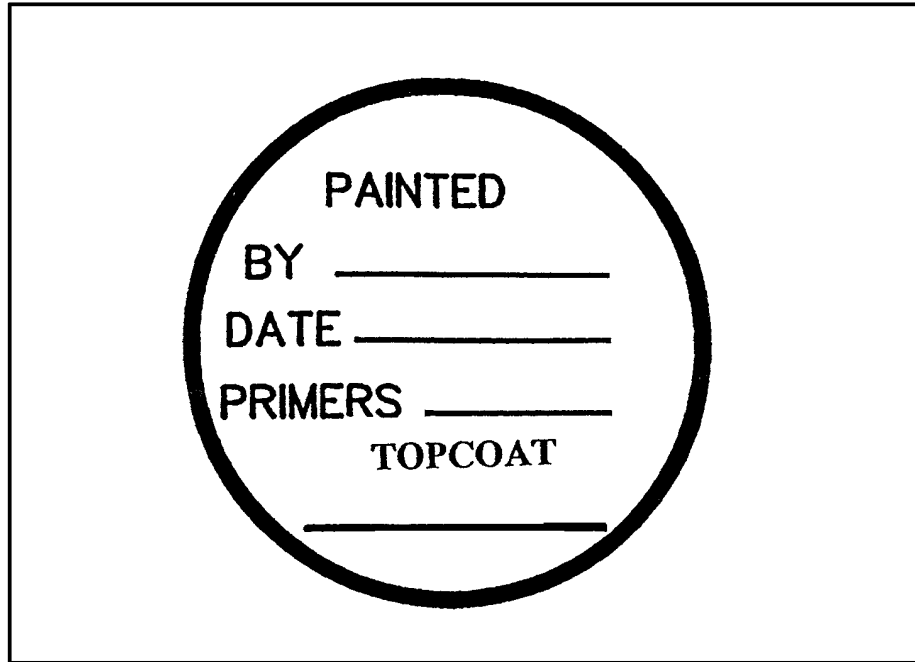

FO9603-41

**Figure B-4. Typical Marking For Paint Facility/Finish Identification Block**

**NOTE**

For non-standard and unique coatings, such as APC, add manufacture product code.

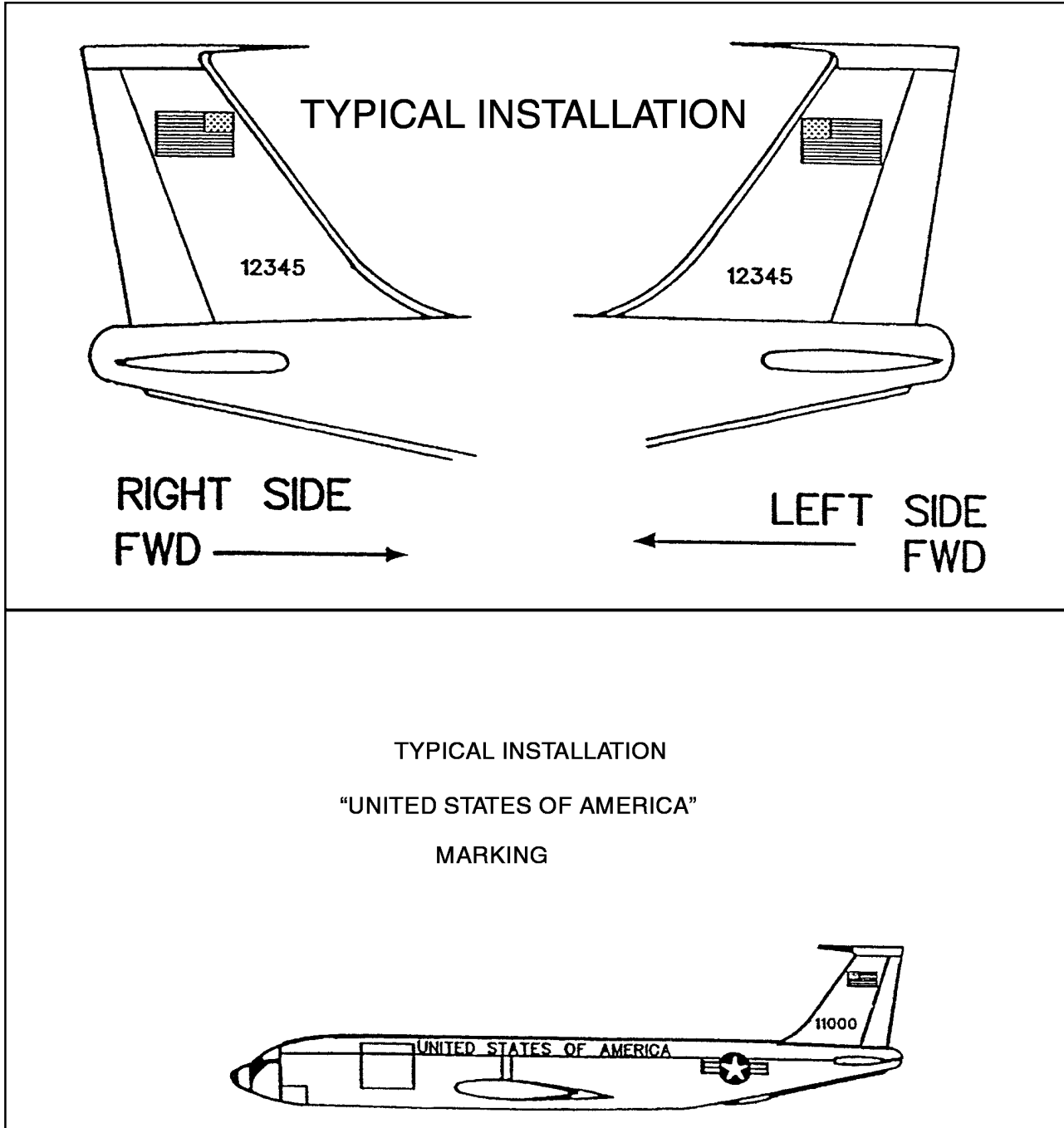





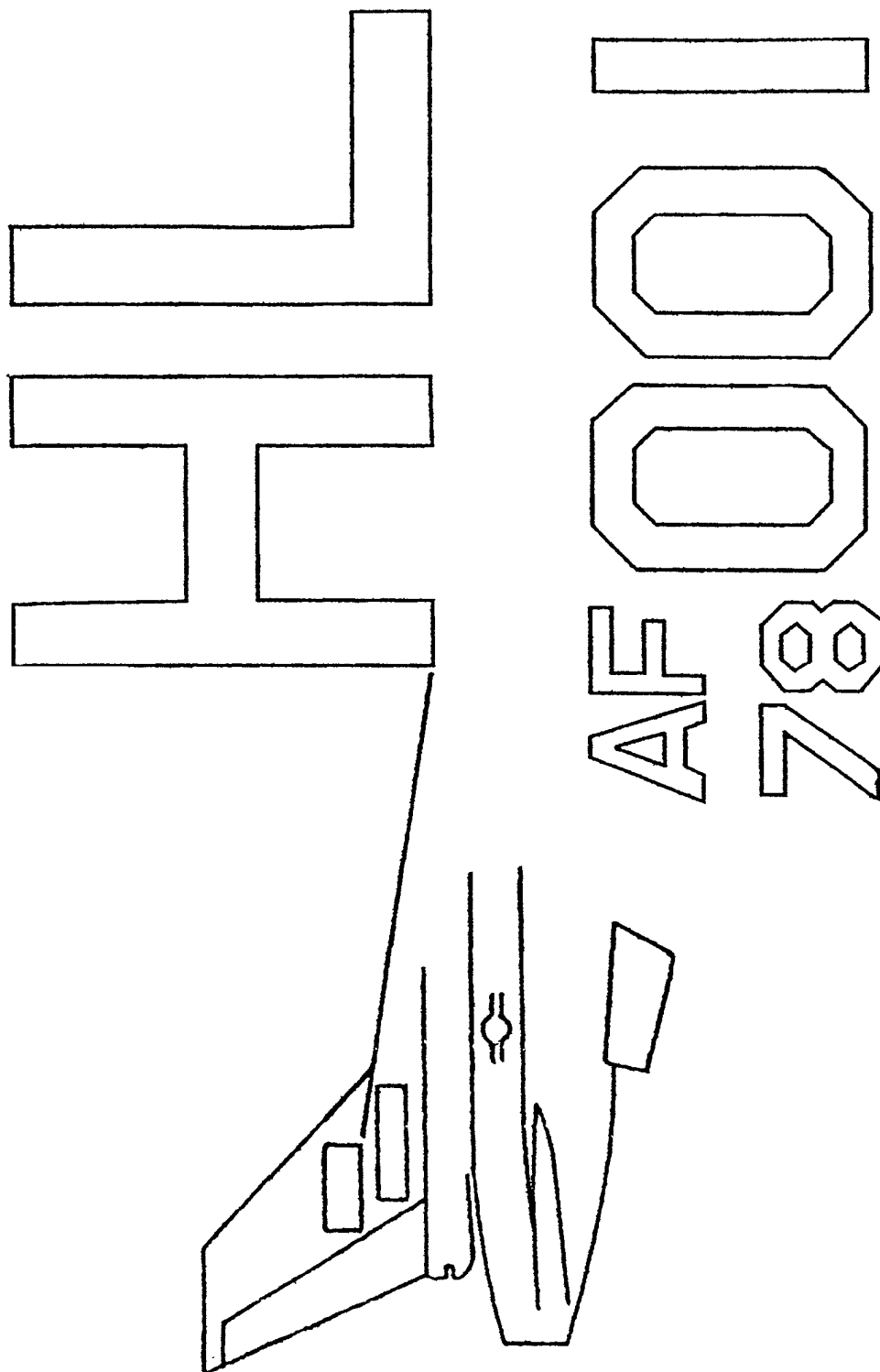







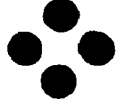

FO9603-43

Figure B-5. "UNITED STATES OF AMERICA" AND AMC Standard Marking Sample



F09603-44

Figure B-6. Distinctive Unit, Serial Number and ACC Standard Sample

FILLING (A)	
<p>FUELING FUELLED FOUR POINT STAR WITH NOTATION OF NATO CODE NUMBER FOR FUEL</p>  <p>(NATO CODE NO)</p>	<p>OXYGEN (BREATHING) TWO HORIZONTAL FILLED RECTANGLES WITH NOTATION OF EITHER " GAS " OR " LIQUID ". FOR GASEOUS OXYGEN INCLUDE CHARGING PRESSURES IN ENGLISH AND METRIC UNITS. FOR LIQUID OXYGEN INCLUDE CAPACITY IN LITERS.</p>  <p>--- psi --- Kg/Cm<sup>2</sup> --- LITERS WHEN NECESSARY</p>
<p>ROCKET FUELS FILLED FOUR POINT STAR IN CRESENT WITH NOTATION OF NATO CODE NUMBER FOR ROCKET FUEL</p>  <p>(NATO CODE NO)</p>	<p>ANTI-DETONANT OR THRUST AUGMENTATION FILLED CHEVRON WITH NOTATION OF NATO CODE NUMBER</p>  <p>(NATO CODE NO)</p>
<p>ROCKET OXIDIZER FILLED CRESENT WITH NOTATION OF NATO CODE NUMBER FOR ROCKET OXIDIZER.</p>  <p>(NATO CODE NO)</p>	<p>AIR CONDITIONING DOT PATTERN</p> 
<p>ENGINE LUBRICATING OIL FILLED SQUARE WITH NOTATION OF NATO CODE NUMBER FOR ENGINE LUBRICATING OIL</p>  <p>(NATO CODE NO)</p>	<p>NITROGEN SERVICES FILLED SQUARE WITH A QUARTER ARC REMOVED FROM EACH CORNER, WITH TYPE OF GAS USED AND PRESSURE IN ENGLISH AND METRIC UNITS</p>  <p>NITROGEN --- psi --- Kg/Cm<sup>2</sup></p>
<p>HYDRAULIC FLUID FILLED CIRCLE WITH NOTATION OF NATO CODE NUMBER FOR HYDRAULIC FLUID.</p>  <p>(NATO CODE NO)</p>	<p>FIRE EXTINGUISHING SYSTEM A FILED DIAMOND WITH NOTATION SHOWING NATO CODE NUMBER</p>  <p>(NATO CODE NO)</p>
<p>DE-ICING FILLED TRIANGLE WITH NOTATION OF NATO CODE NUMBER FOR DE-ICING FLUID</p>  <p>(NATO CODE NO)</p>	<p>EXTERNAL ELECTRICAL CONNECTIONS FILLED " E " WITH LOWER LIMB SHORTENED STATING SERVICE AND VOLTAGE DETAILS</p>  <p>... SERVICING ... STARTING ETC 28 V OR 112 VDC 115/200 V, 400 CYCLES</p>
<p>COOLANT TWO FILLED HORIZONTAL S'S WITH NOTATION OF NATO CODE NUMBER FOR COOLANT AND PERCENTAGE COMPOSITION IF NECESSARY</p>  <p>(NATO CODE NO) WATER ___% (98749) SOLUBLE OIL ___%</p>	<p>GROUNDING OR EARTHING RECEPTACLE A FILLED INVERTED " T " WITH TWO PARALLEL BARS UNDERNEATH WHICH DIMINISH IN SIZE</p>  <p>GROUND (EARTH) HERE</p>
<p>PNEUMATIC SYSTEM FILLED X WITH NOTATION OF MAXIMUM CHARGING PRESSURE IN ENGLISH AND METRIC UNITS</p>  <p>MAXIMUM --- psi --- Kg/Cm<sup>2</sup></p>	<p>INSPECTION OF BATTERY A FILLED ELECTRIC FLASH SIGN</p> 

(A) COLOR-BLACK OR WHITE ACCORDING TO BACKGROUND





**NOTE** MARKINGS WILL BE APPLIED USING CONTRASTING COLORS APPROPRIATE TO THE BACKGROUND.

FOR ADDITIONAL REFERENCE GUIDANCE TO THE BACKGROUND, SEE ALSO TO 42B1-1-15 (NATO/ASCC INTERCHANGEABILITY AVIATION FUELS, LUBRICATES, AND ALLIED PRODUCTS)

FO9603-45

Figure B-7. Aircraft Markings, Servicing and Precautioning (Sheet 1 of 2)

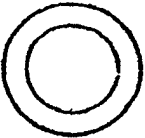
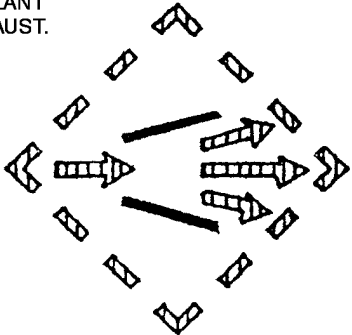

FILLING		GROUND HANDLING	
PNEUMATIC STARTER CONNECTION	A FILLED X CIRCUMSCRIBED BY A FILLED RING	JACKING POINT	
REFRIGERANT REPLENISHMENT	TWO FILLED TRIANGLES WITH APEXES JOINED ON HORIZONTAL CENTER LINE.	SLINGING OR HOISTING POINTS	
		MOORING OR PICKETING	
HAZARD			
		AIRBORNE AUXILLARY TURBINE POWER PLANT INLET AND OR EXHAUST.	
EXPLOSIVE ACTUATED DEVICES	<p>MARK BOTH SIDES OF FUSELAGE</p> <p>RED FILLED EQUILATERAL TRIANGLE APEX DOWN, OF THE LARGEST PRACTICABLE SIZE UP TO A 9 INCH (23cm) SIZE TO BE APPLIED TO THE EXTERNAL PART OF AIRCRAFT ADJACENT TO THE EXPLOSIVE DEVICE. THE WORD " DANGER " TO BE WITH ITS TOP TO A SURROUNDING PERIPHERAL RED LINE.</p>		
<p><b>NOTE</b> MARKINGS WILL BE APPLIED USING CONTRASTING COLORS APPROPRIATE TO THE BACKGROUND.</p>			

FO9603-46

Figure B-7. Aircraft Markings, Servicing and Precautioning (Sheet 2)

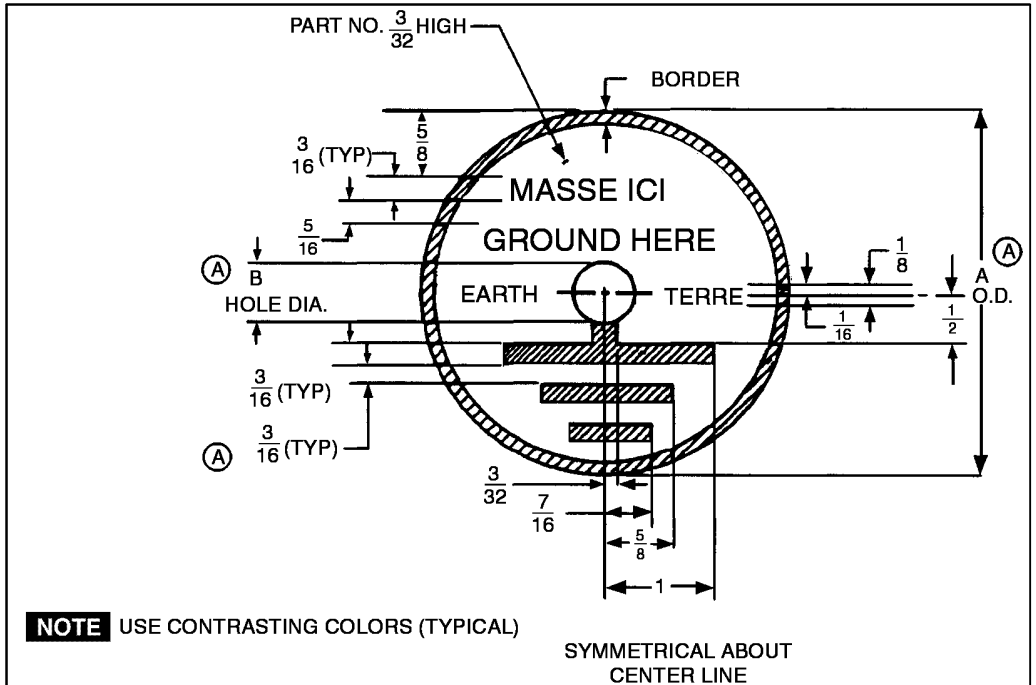

FO9603-47

Figure B-8. Ground Here, International Symbol

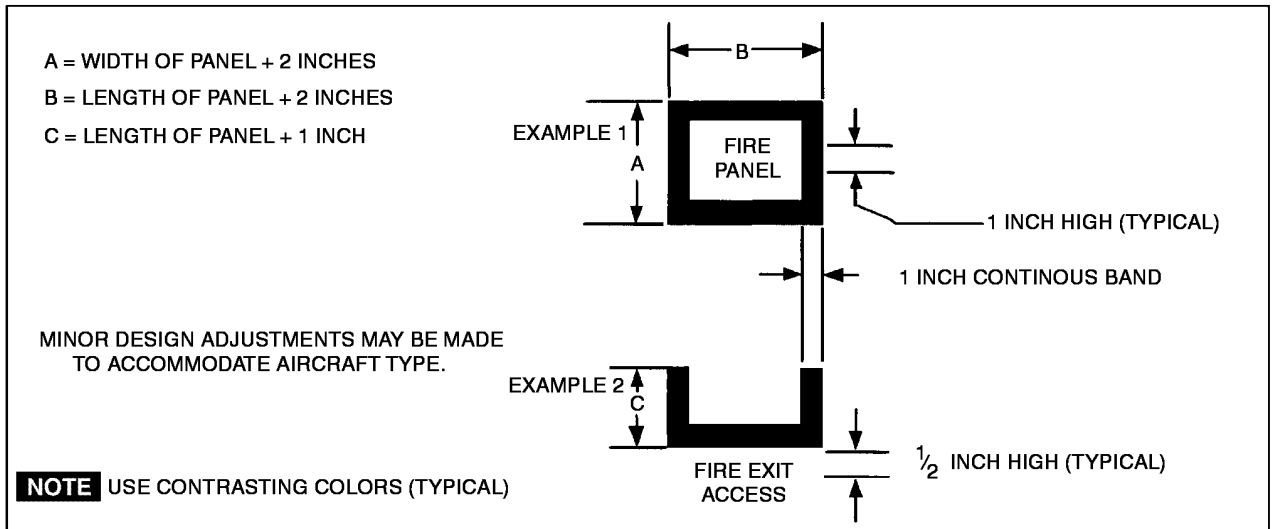

FO9603-48

Figure B-9. Markings For Fire Access Panel

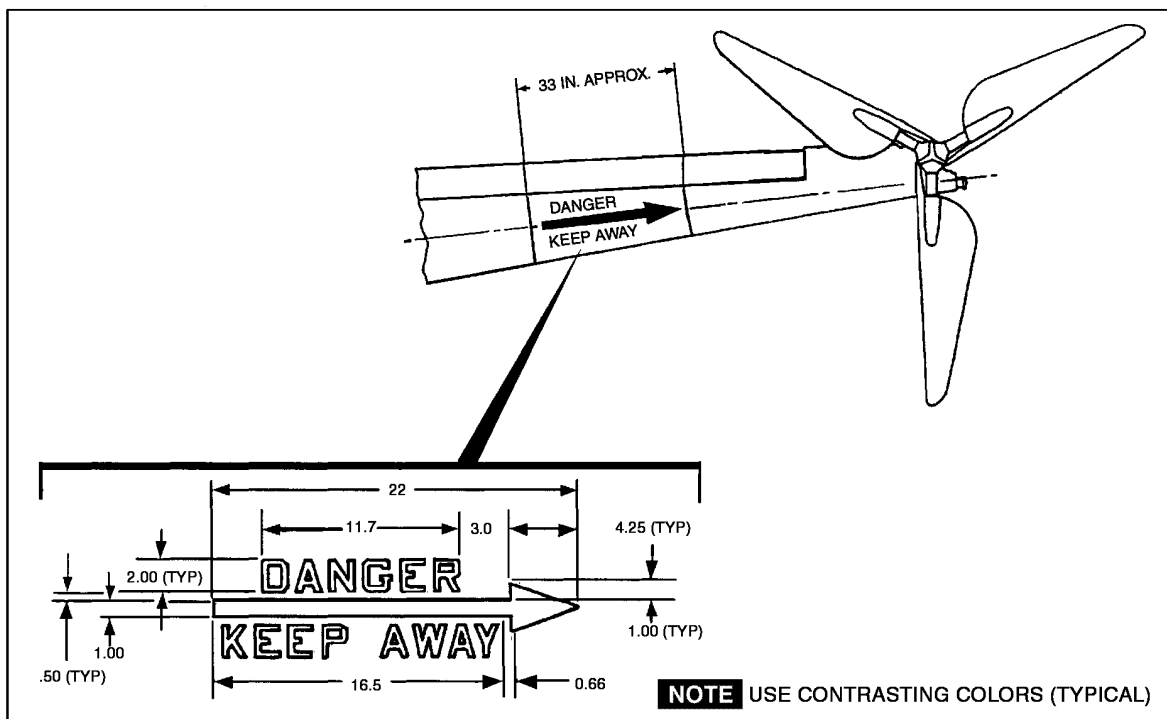

FO9603-49

Figure B-10. Helicopter Tail Boom Markings

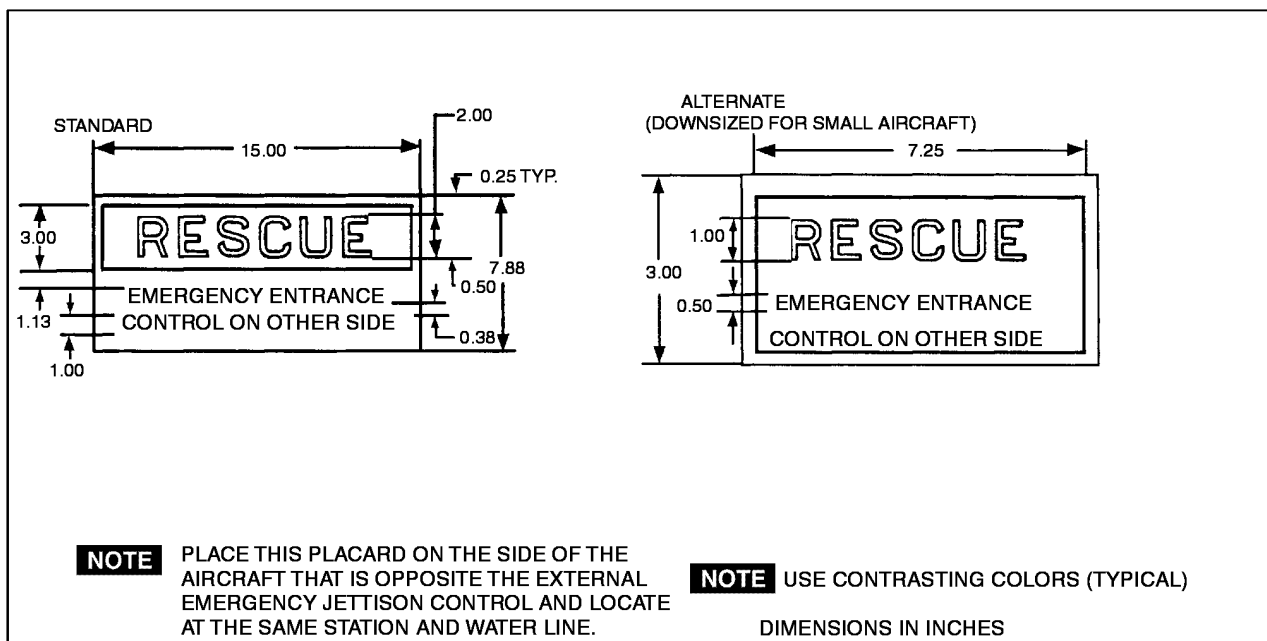

FO9603-50

Figure B-11. Typical Emergency Instruction Markings

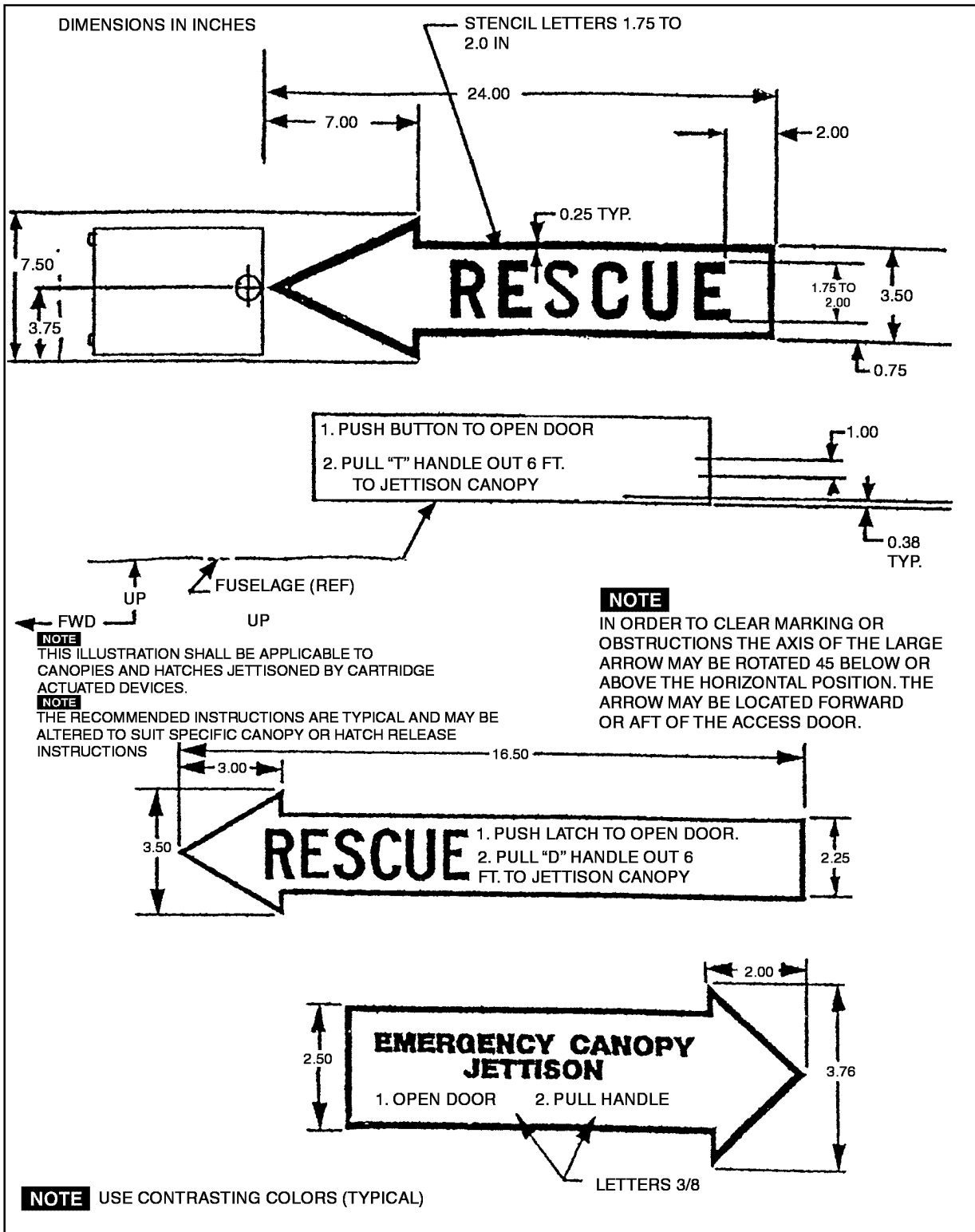

FO9603-51

Figure B-12. Typical Emergency Entry Markings

## GLOSSARY

### A

**ACCELERATOR** — A substance which speeds up the polymerization of a synthetic resin.

**ACRYLIC RESIN** — Any of a group of transparent thermo-plastic resins formed by polymerizing esters of acrylic acid or methacrylic acid.

**ALIPHATIC** — An organic chemical whose carbon atoms are not in a ring form. A straight-chain compound. Mineral spirits, some naphthas, and kerosene are typical aliphatic compounds.

**ALKYD RESIN** — One of the major synthetics formed by polybasic acid reaction with polyhydric alcohols. Primarily used in enamels but also in combinations in some other types of coatings.

**ALLIGATORING** — A condition where cracks in the film are caused by contraction of the coating when a sudden change in temperature occurs during drying. It may also occur because of insufficient drying time between lacquer coats, or because of poor penetration or wetting, or when a hard topcoat has been applied over a soft undercoat. These cracks usually penetrate to the metal surface.

**AMINE** — An organic chemical containing carbon hydrogen and nitrogen. Certain amines may be used as convertors for epoxy resins.

**ANHYDROUS** — Containing no water.

**AROMATIC** — An organic chemical possessing the benzene ring structure. Benzene, toluene and xylene are typical aromatic hydrocarbons.

### B

**BAKING FINISH** — Any paint or varnish which requires temperatures in excess of 150° F for the development of desired properties. The usual baking difficulties are the result of over-baking or under-baking schedules. Over-baking will result in a hard, brittle film with less adhesion than requirements demand. Proper correction of baking faults demands strict adherence to the instructions of the manufacturer.

**BINDER** — The non-volatile portion of a coating vehicle. It generally consists of drying oils, resins, or combinations thereof.

**BLEEDING** — A condition caused by pigments or dyes in the under surfaces floating up into the top coating. Bleeding

may occur when material is applied with unclean spraying equipment or when a topcoat/second coat is applied too soon.

**BLISTERING (OR BUBBLING)** — Blistering may occur when there is poor air circulation during drying of the coating. Unbalanced solvents in the structure of the coating will also cause this effect. Temperature differences between the part being sprayed and the coating will also cause air pockets or blisters. Water in air lines can cause blistering, and daily draining of the water filters on air lines will help minimize this problem.

**BLOOMING (OR HAZING)** — The appearance of blooming is similar to blushing, though the underlying reasons are different. Blooming is the result of rubbing the finish too soon after application, the use of too coarse an abrasive or too hard a rubbing stroke. When blooming does occur, it may be removed by washing with a mild soap solution and warm water, followed by chamois skin. Properly dried and hardened surfaces will not bloom when rubbed or polished.

**BLUSHING** — Commonly referred to as clouding or whitening, blushing is the result of moisture being present on the film surface during the drying period. Although the fault commonly lies in improper drainage of the air line during finishing operations, the condition is also caused by high humidity conditions within the finishing room. Improper selection of solvents will also cause blushing.

**BODY OF PAINT** — The liquid portion without the volatile solvents and water.

**BODYING** — See Gelling.

**BROWN SPOTS** — Spots which occur in a lacquer film when oil is permitted to get into the material. As a precautionary measure, drain the water and oil separators daily.

**BUBBLES** — When improper quality or quantity of thinner is used, bubbles often occur (also known as "solvent pop"). To help prevent this defect, use correct proportions of thinner at all times. Application of a topcoat before the initial coat has cured properly or at too high a temperature can also cause bubbles.

**BUCKLING** — A nitrocellulose lacquer film may shrink or buckle when sprayed over an oil base undercoat. If necessary to overcoat oil paint with lacquer, make the first top coat as light as possible.

**C**

**CASE HARDENING** — The formation of a hardened top surface with a soft underbody. Proper relative humidity conditions within the drying room will assist in eliminating this condition.

**CATALYST** — A substance which changes the rate of a chemical reaction without itself undergoing permanent change in its composition.

**CHALKING** — Deterioration of an organic coating upon exposure that results in a powdery, chalky residue on a painted surface.

**CHECKING** — Slight breaks in the film which do not penetrate to the underlying surface. It occurs when lacquer coats are applied too heavily or without sufficient time allowed for drying between coats.

**COBWEBBING** — Filaments of paint which appear as cobwebs instead of fine droplets.

**COLLOID** — A very finely divided (but not molecular) dispersion of a solid in a liquid. Colloidal dispersions do not settle and the particles are too small to be observed by ordinary microscope.

**CONSISTENCY** — Consistency is another word for viscosity of a wet material. The term may also be applied to the resistance to deformation of a cured film.

**CONVERTER** — A substance which causes a resin to polymerize or cure. Polyamides and amines are two examples of epoxy converters.

**COVERAGE** — The surface area which can be coated with a given volume of coating applied at a given film thickness. Coverage is usually expressed in square feet per gallon at one mil dry film thickness. Coverage is not related to hiding power.

**CRACKING** — Cracking occurs when the various components of a lacquer are not blended or mixed properly, or when coatings not compatible with one another are used together.

**CRATERING** — A defect in a coating resulting in craters or fish eyes. Most often caused by the presence of grease, oil, silicone polishes or other similar contaminants on the surface.

**CRAWLING** — The reverse of crazing, that is, a more flexible coating is applied over a hard or brittle film.

**CRAZING** — When lacquer films expand and contract, a series of fine hair line cracks (crazing) results. Crazing frequently occurs when a very heavily pigmented surface coat is applied over a more flexible undercoating. The elastic coating of lower filler content will expand and contract more easily than the heavily pigmented coating.

**CRYSTAL LACQUERS** — A decorative finish which is achieved by re-crystallization of dissolved lacquer bases. It occurs after the thinners have evaporated. Pearl essence or mother of pearl finishes may be produced in this fashion.

**CRYSTALLINE FINISH** — A crystalline like, decorative finish is accomplished by using certain gas checking oils which on drying produce the pattern.

**CURDLING** — Curdling usually occurs when a high evaporative but weak solvency thinner is used with a lacquer or enamel. Control of solvency and evaporation rate will prevent curdling.

**D**

**DECAL** — A plastic film with an adhesive on one side that adheres to glass, wood, metal, etc, that transfers decorative pictures or designs printed on the specially prepared film to the surface.

**DILUENT** — A thinner blended with an organic coating mixture to increase its volume and/or reduce its viscosity.

**DISPERSION** — An intimate mixture of finely divided solid particles in a liquid substance. Paints are dispersions of pigments in a vehicle.

**DOUBLE COAT** — A double application of paint. This does not mean two consecutive passes of the spray gun. One coat is applied by a double or cross pass of the gun followed by a second similar application after the first coat has set up.

**DRIER** — A catalytic material which when added to a drying oil or drying oil modified coating accelerates the rate of drying. A substance which speeds the reaction of a binder with oxygen. Naphthenates of cobalt and manganese are common driers.

**DRYING OIL** — An oil which readily absorbs oxygen from the air to form a durable film.



**DRYING TIME** — The time required for a coating to attain various stages of dryness. Three commonly referred to drying times are: dry to touch, dry to handle and dry hard (recoat). Drying time is greatly affected by temperature, humidity, and air movement.

**DUST COAT** — a very light coat of a coating, which will improve adhesion.

## E

**EMULSION** — An intimate suspension of two or more liquid substances which are not mutually soluble but which do not ordinarily separate. Examples: milk (butterfat and water), self-polishing floor waxes (wax, solvent, water), vehicle for water-thinned latex paints.

**ENAMEL** — A coating characterized by an ability to form an especially smooth finish film.

**EPOXY RESIN** — A synthetic resin produced by the reaction of epichlorohydrin and bisphenol. Epoxy resins may be used alone (unmodified) or modified with drying oils (epoxy esters) for coating vehicles.

**EXTENDER PIGMENTS** — Pigments used to provide texture, bulk or hardness to a coating. Also known as inert pigments. Magnesium silicate and diatomaceous silica are examples of extender pigments.

## F

**FERROUS** — Magnetic metals derived from steel or iron.

**FILLER** — A material of pigmented composition used to fill irregularities and undesirable depressions after a primer coating is applied and prior to finish coating application.

**FILLING POWER** — The degree a filler material hides irregularities of texture.

**FLASH POINT** — The minimum temperature at which the vapors of a liquid will ignite. An indication of the flammability of a product; the higher the flash point, the safer the product.

**FLATTENING AGENT** — A material added to a coating to reduce the gloss of the cured film.

**FLOODING** — A change in color of a coating from the time it is applied until the time it sets caused by fines in the pigment portion floating to the surface. The result is a final shade different from the original.

**FORCE DRYING TEMPERATURE** — A temperature between room temperature and 175° F to which a coating is exposed to accelerate curing.

## G

**GELLING** — The irreversible transformation of a liquid to a solid without the loss of weight through evaporation.

**GLOSS, SPECULAR** — The luster, shininess, or reflective ability of a surface; or the ability of a surface to reflect light regularly when light strikes the surface at a 60 degree angle. It is based upon the degree of optical smoothness of a surface, variations in smoothness being microscopic. Values above 90 are classified as high gloss, 80 to 90 as full gloss, 35 to 45 as semi-gloss, 5 to 7 as flat or camouflage and 3 or less as gunship quality. Seven or less is also classified as lusterless.

## H

**HIDING POWER** — For an organic coating, it is either the degree to which the base material has been obliterated from view or the relative smoothness or surface leveling a coating may produce.

**HOLIDAY** — An unintentional skipped area, missed while applying a coating. Holidays can be avoided by using contrasting colors for alternating coats.

**HYGROSCOPIC** — The ability to attract or absorb water.

## I

**INFRARED LAMP** — A heat lamp commonly used in paint drying operations that emits infrared light.

**INHIBITOR** — A substance which slows down a chemical reaction.

**INORGANIC** — Chemical compounds based chiefly on elements other than the carbon-hydrogen-oxygen group. Inorganic compounds are divided into four classifications:

**Acids** — Materials such as sulfuric, hydrochloric (muriatic), nitric, and phosphoric acids.

**Alkalies** — A base material such as sodium hydroxide (caustic soda), potassium hydroxide (caustic potash), ammonium hydroxide (ammonia).

**Salts** — Materials produced by the reaction of an acid and an alkali. Sodium chloride (table salt), magnesium sulfate (epsom salt), calcium chloride, copper sulfate.

**Oxides** — A combination of a metal and oxygen such as iron oxide (rust), zinc oxide, titanium dioxide (white pigment), silicone dioxide (sand and glass).

**INTERCOAT** — A layer of paint that is “sandwiched” between two others. Also refers to something occurring between coats, as in “intercoat adhesion”.

## L

**LATEX** — A water suspension of fine particles of rubber or rubber-like materials.

**LEVELING** — The degree to which a film will smooth out after application is its leveling ability. Improper solvent or driers may prevent proper leveling.

**LEAFING** — The ability of an aluminum or gold bronze paint to exhibit a brilliant or silvery appearance. This occurs when the flat pigment particles align themselves parallel with the coated surface so as to give the appearance of a solid sheet of metal.

**LIFTING** — Separation of a coating film from a surface when solvents from a topcoat penetrate an existing coating which has not dried sufficiently to permit proper adhesion. In all instances where one finish is applied over another it is important that the undercoat be sufficiently dry; otherwise, poor adhesion will result.

**LIVERING** — Gelling of a paint that occurs when the pH of a paint is lowered, such as when acid-producing reactions occur in the material. In many cases, this difficulty can be remedied by slowly stirring into the livered material a very slow evaporating paint reducer.

## M

**MIL** — A unit of measurement for the thickness of a coating film. One mil equals 1/1000 (0.001) inch.

## N

**NAPHTHA** — The product of the distillation of the solvent fractions obtained from the thermal decomposition (cracking) of coal or petroleum. A volatile, flammable fluid consisting chiefly of mixed hydrocarbons. It can be aromatic with a benzene ring structure or aliphatic with a linear structure.

**NITROCELLULOSE** — A binder used in most lacquers; principally air drying. It may be modified with resins and plasticizers for improved gloss, adhesion and flexibility. An ester of nitric acid and cellulose produced by the action of nitric acid upon wood, cotton, or some other form of cellulose in the presence of concentrated sulfuric acid.

**NON-FERROUS** — A description of metals other than iron.

**NON-VOLATILE VEHICLE** — The liquid portion of a paint, enamel, varnish, or related products not including the volatile thinners and water.

## O

**ORANGE PEEL** — Pebble effect appearance caused by too high an air pressure during spraying, the spray gun being held too close to the surface, or using a highly volatile thinner which prevents the normal flow of lacquer solids.

**ORGANIC** — Chemical compounds chiefly composed of carbon, hydrogen and oxygen in a multitude of molecular arrangements. The term organic was established when it was thought that organic compounds could be produced only by living organisms. Many organic compounds are produced synthetically today. However, even these are derived from former living plants and animals (coal and oil are the chief sources of raw materials for organic chemicals). Examples of organic compounds: gasoline, alcohol, sugar, fish oil, glycerin.

**ORGANIC COATING** — A finish/paint system such as a lacquer or an enamel that cures/dries by solvent or volatile component evaporation only and not by chemical reaction.

**ORGANISOL** — Finely divided or colloided dispersion of a resin in a plasticizer with solvents or other materials.

**OXIDATION** — A chemical reaction involving the reaction of a substance with oxygen. Iron rusts by oxidation. Oil-containing coatings dry or cure by oxidation.

## P

**PERMEABILITY** — The extent to which a coating or other film will allow air or water to pass through it.

**pH** — A term used to indicate acidity or alkalinity. The pH scale runs from 0 to 14; pH 7 is neutral, less than 7 is acid, 7 to 14 is alkaline. The further the rating is from seven, the greater the acidity or alkalinity.

**PIGMENT** — The solid particles used in the preparation of paints, lacquers and enamels which are substantially insoluble in the vehicle and provide color, under film protection and special effects.

**PITTING** — A condition which occurs when a lacquer is sprayed at high pressures and at temperatures below 65° F. It will occur if a lacquer used in spraying has been stored in a cool place and has not been allowed to attain room temperature.

**PLASTICIZER** — Substances added to soften or otherwise modify the properties of a finished resin without excessive sacrifice of strength and rigidity.

**PLASTISOL** — Colloidal dispersion of a resin in a plasticizer without solvent.

**POCK MARKS** — Marks caused by bursting of trapped air bubbles in a porous film. Too high an air pressure or too

thick a coating can result in pock marks. To overcome this condition, apply thinner coatings, use less air pressure, and use a high solvency thinner.

**POLYMER** — A substance composed of large molecules formed by the combination of a number of simple molecules with one another by chemical reaction.

**PRIMER** — A coating applied directly to the basic metal or pretreated metal and upon which a subsequent coating or topcoat is applied.

**PSI** — Pounds per square inch. A measure of pressure of fluids and gasses.

## R

**RAISING** — The appearance of wrinkles or blisters in a film; often due to a reaction of lacquer solvents with unoxidized oil films in oil base undercoats.

**RELATIVE HUMIDITY** — The ratio of the actual amount of moisture in the air to the maximum amount it could contain at the same temperature, expressed as a percentage.

**RESIN** — A natural or synthetic substance usually organic in composition, characterized by being amorphous (non-crystalline), isotropic (properties being the same in all directions), plastic, often sticky and usually fusible and soluble at some stage in its manufacture or processing.

**RUNS** — Rivulets in a coating caused by too much organic coating material or thinner being applied to an area at one time.

## S

**SOLVENT** — Any liquid which will dissolve another substance. Solvent power of a liquid is specific, that is, it can dissolve certain substances but not others.

**SOLVENT RESISTANT COATING** — A finish/paint system such as an epoxy or a polyurethane that is catalyzed and cures by chemical reaction in conjunction with solvent evaporation. These coatings are highly resistant to solvents/thinners after they completely cure.

**SPRAY DUST** — Paint dust that causes surface roughness when a spray gun is held too far from the work, especially when a highly volatile thinner is used. This is caused by solid particles in the coating material drying up while traveling from the nozzle to the surface being sprayed. Insufficient thinning or too high air pressure may also cause spray dust. Correct by spraying at lower air pressures, adjusting distances to between 6 to 10 inches from the work, and/or by increasing the thinner content.

**STRIPPING** — Removal of paint from a surface.

**SURFACE TENSION** — The property of a liquid by which the surface film of a liquid tends to form into a sphere. Surface tension affects the ability of a liquid to wet a surface. The higher the surface tension, the poorer the wetting.

## T

**TIECOAT** — A two-component, VOC, solvent-borne, lead and chromate free epoxy coating particularly formulated for its adhesion properties to other coatings.

**THIXOTROPY** — The property of a coating which causes it to undergo a gel-sol-gel transformation upon agitation and subsequent rest. Upon agitation it becomes quite fluid but readily falls back again to the semi-solid form after the agitation is stopped.

**TONER** — Organic pigments which do not contain inorganic pigments or inorganic carrier bases.

## V

**VARNISH** — A liquid resin material which after application converts to a transparent or translucent solid material.

**VEHICLE** — The liquid carrier portion of a paint/coating.

## W

**WET SPOTS** — If metals are not thoroughly cleaned of oils and greases before painting, those areas which retain the foreign material become wet spots or fish-eyes. The condition is characterized by a sticky coating film which requires extremely long drying time and often remains soft or wrinkled. Stripping of the paint film, cleaning, and refinishing is required to correct this condition.

**WRINKLE FINISH** — In those cases where wrinkling is undesirable, it is a defect caused by improper application, usually of too heavy a coating, an abnormally high or too rapid a rise in temperature, or high humidity. Avoid these conditions by applying thinner films, allowing sufficient drying time between coatings, and avoiding extremes of temperatures and humidity.

## Z

**No. 2 ZAHN Cup/No. 4 Ford Cup** — A small portable viscosity measuring device.

